

USER'S GUIDE

Version 5.0

GIGA Board



Table of Content

Preface	3
About this Manual	3
Copyright Information	3
Safety Instructions	3
Safety Notices	4
Introduction	5
Features	5
Package Contents	6
Hardware Components	7
Status LCD	7
Getting Started	8
Connecting the earth ground wire	8
Rack Mounting	8
Hotswap replaceable IEX GIGA Controller	9
Making Connections	10
Connecting Input Power	13
Connecting Output Devices	11
Connecting EMD31	12
Dip-Switch for adress setting	12
Daisy Chain setting	13
Connecting the Power Share adaptor and cable	14
Connecting to a LAN/WAN	20
Using LCM operational buttons	21
(RCM) Residual Current Monitoring	23
(SPD) Surge Protection Monitoring Option	24

Table of Content

Using the Web Interface.	25
Summary Overview-System Overview.	25
Summary Overview-Alarm List	26
Summary Overview-Network Connection.	26
Outlet Sequential Startup	27
Power Management-Inlet Configuration.	27
Power Management-Outlet Control.	28
Power Management-Outlet Grouping	29
Power Management-Outlet Schedule	29
Power Management-Environment Monitoring	30
Settings-General Setting	31
Settings-TCP/IP.	31
Settings-Accessible IP settings	32
Setting-Network Acces Protection	32
Settings-Network Service	33
Setting up the LDAP step by step	34
Setting up the TACACS+ step by step.	36
Settings-Radius User	38
Settings-SNMP Setting	38
Setting-Email Settings	39
Setting-User Settings.	39
Log and Notification-System Log.	40
Log and Notification-Event Log	40
Log and Notification-Inlet History Log	40
Log and Notification-Outlet History Log	41
Log and Notification-Environment History Log	41
ADVANCED – SYSLOG Setting	42
ADVANCED – Maintenance	42
ADVANCED – Import / Export	42
ADVANCED – Links Setting	43
Dual Ethernet Mode	44
ADVANCED – Wifi or 3G/4G dongle setting	48
ADVANCED – Inlet & Outlet upgrade	49
ADVANCED – EMD31 upgrade	49

Preface

About this Manual

Congratulations on purchasing a SCHNEIKEL PDU. This user manual provides detailed descriptions of the hardware components and how to use the product. Read this manual carefully and follow the instructions before installing.

Copyright Information

No part of this manual, including the products and software described in it, may be reproduced, transmitted, transcribed, stored in a retrieval system, or translated into any language in any form or by any means, except documentation kept by the purchasers for backup purposes, without the express written permission of the manufacturer.

Products and corporate names appearing in this manual may or may not be registered trademarks or copyrights of their respective companies, and are used only for identification or explanation and to the owners' benefit, without intent to infringe. All trademarks are the property of their respective owners.

Safety Instructions

Follow these safety instructions to avoid injury to yourself and damage to the SCHNEIKEL PDU.

- To reduce the risk of fire or electric shock, install the unit in a temperature-controlled indoor area free of conductive contaminants. Do not place the unit near liquids or in an excessively humid environment.
- Do not allow liquids or foreign objects to enter the unit.
- The unit does not contain any user-serviceable parts.
- Do not open the unit.
- Servicing, maintenance, and repair for this equipment must be performed by qualified service personnel. Remove rings, watches and other jewelry before servicing the unit.
- Before maintenance, repair or shipment, the unit must be completely switched off and unplugged and all connections must be removed.
- Before plugging in the power cord of the device, make sure that the power source rating matches the power rated indicated on the product labels.
- Use a harmonized and certified power cord when connecting any device to the outlets.
- The digital output can only connect switches, indicators, or other output devices that are normally open or normally closed.

Preface

Safety Notes



Caution:

This unit has been provided with a real time clock circuit. There is a danger of explosion if the battery is incorrectly replaced. Replace only with a 3V Lithium cell (CR1220) or equivalent type. Discard used batteries according to the manufacturer's instructions.



Caution:

Rack-Mounted Equipment – The unit is intended to be rack-mounted, the Installation Instructions shall contain wording to address the following concerns when the unit is mounted in a rack system.

“The equipment is to be installed in an environment with maximum ambient temperature must not exceed 60°C.”

“The openings on the enclosure are for air convection hence protected the equipment from overheating. DO NOT COVER THE OPENINGS.”

“Lay this equipment on a reliable surface when installing. A drop or fall could cause injury.”

“The equipment shall be installed according to specification as nameplate. Make sure the voltage of the power source when connecting the equipment to the power outlet. The current of load and output power of loads should not be over the specification.”

“This equipment must be connected to the reliable earth before using.”

Introduction the SCHNEIKEL PDU

The SCHNEIKEL PDU, is an intelligent power strip designed to power monitor the input and circuit breaker consumption and auto email history report to supervisor for power bill charge. At the same time, provides the useful ability of managing power for any combination of network equipment connected to it. Users can control the power on/off for any device connected to the PDU remotely, using a console or Ethernet connections.

It's also equipped with a console port for connecting upto 8 EMD31 (Environmental Monitoring Device) in cascade for sensing temperature and humidity along with two alarms that can be activated when either of the sensors shows unusual values.

Features

- To calculate the power consumption on hourly basis, and have an accumulation of daily
- Provide detail data-logging for statistical analysis and diagnostic then auto email daily history report
- Daisy-chaining can cascade up 16 power strips
- Sequential power-up on the outlets / Allows users to configure the sequence in which power is turned on or off for each outlet
- Intelligently turn on/off devices based on event occurrence or planned schedule
- Event notification by pop-up/Sending Trap or E-Mail for events notification
- Upto 42 power outlets that can be turned on or off in multiple ways, with easy monitoring of current consumption
- Set over-current watchdog for each outlet (Threshold settings for overcurrent warnings and alerts)
- Versatile sensors supported through EMD31 (Environmental Monitoring Device) inputs, 8 sensors can be deployed in cascade
- Comprehensive power management and flexible configuration through web browser, NMS, SNMP V1,2,3
- Support Secure Socket Layer V3 and Secure Shell V2 protocols
- Administrator and multiple users with password protection for doublelayer security
- Address-specific IP security masks to prevent unauthorized access
- User-friendly interface to display input and output status
- Upgrade utility for easy firmware upgrade
- Models available in 220-250V, 380-415V, 120-208V and 208V

Introduction the SCHNEIKEL PDU

Package Contents

Make sure the SCHNEIKEL PDU package has the following items. If any of the items are missing or damaged, contact your nearest service center or vendor.

1. SCHNEIKEL PDU
2. IPFIX001 (x2)
3. IPFIX002 (x2)
4. IPFIX003 (x2)
5. Screws (x6)
6. Power share special patch cord
7. Quick Install Guide

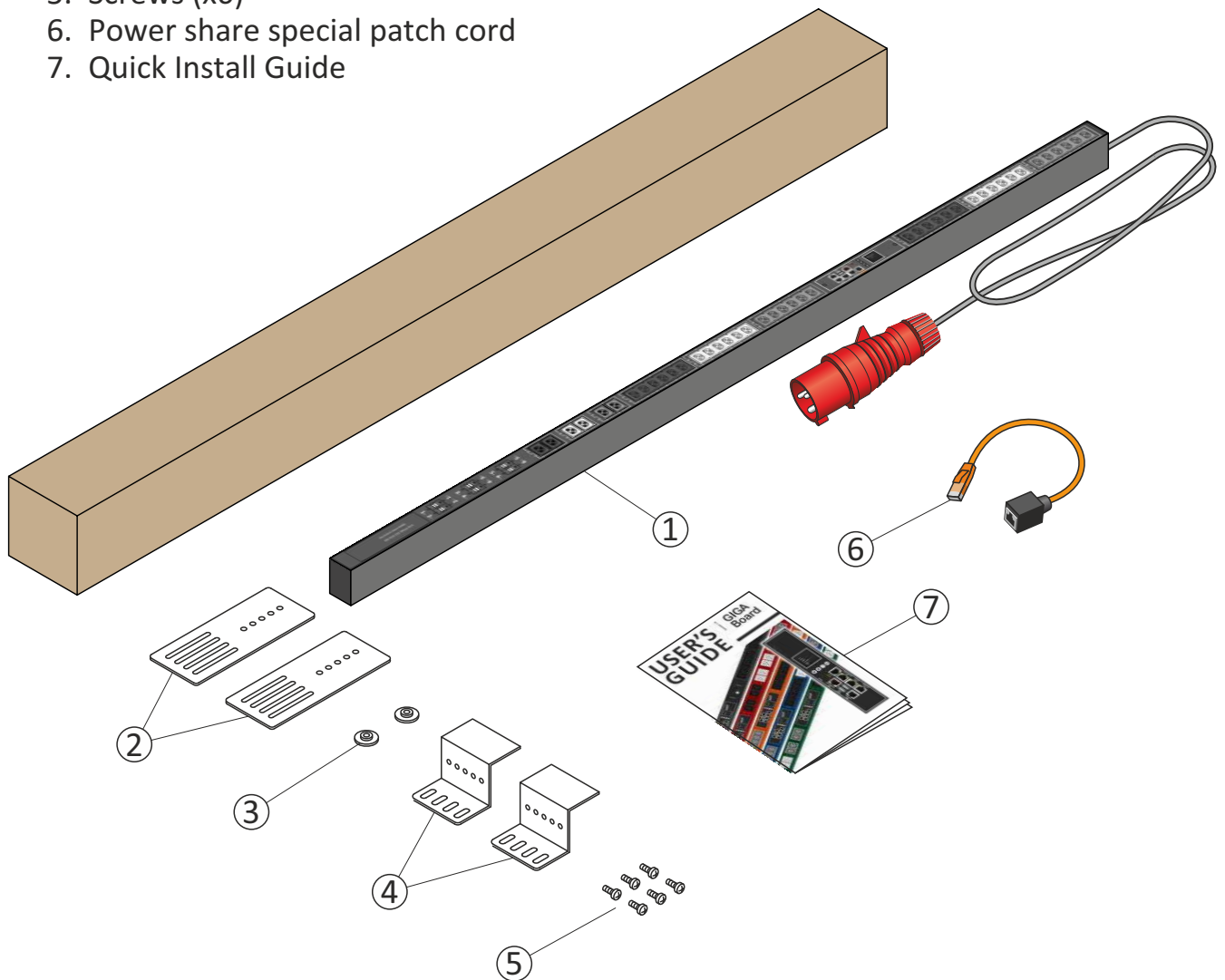

Introduction the SCHNEIKEL PDU

Hardware Components

The following sections provide descriptions about the front panel components and how to use them.

	Component	Description
1.	Inlet	Power lead to be connected to the Data Centre power source
2.	Breaker	Prevent excessive current flow to protect the system
3.	OLED Display	Display input Power Data
4.	Mounting Options	Different choice of mounting options

OLED Display

The front panel of the Schneikel PDU has a colored OLED screen that provides information about the PDU power status.

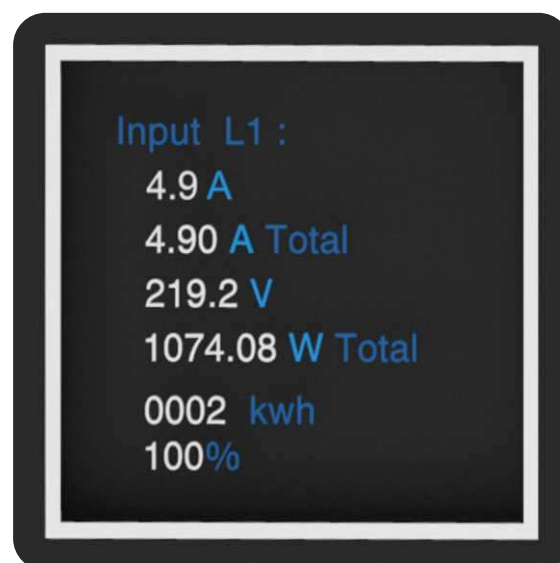

Getting Started

Connecting the earth ground wire



Rack Mounting

The PDU can be installed in most standard racks. After attaching the ears to each side of the device, position the device in the rack and align the holes in the ears (mounting brackets) with the hole in the rack.

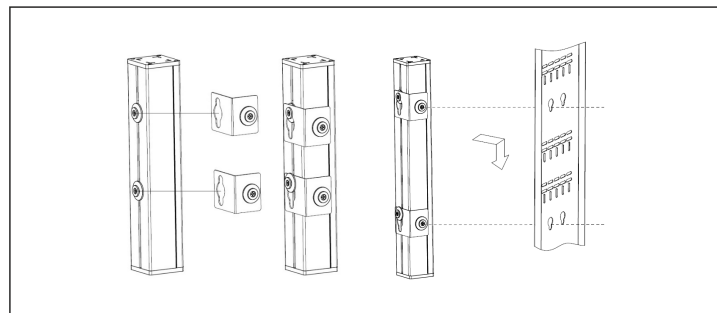
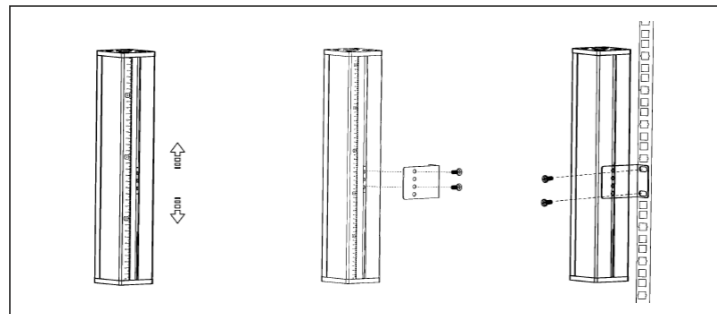
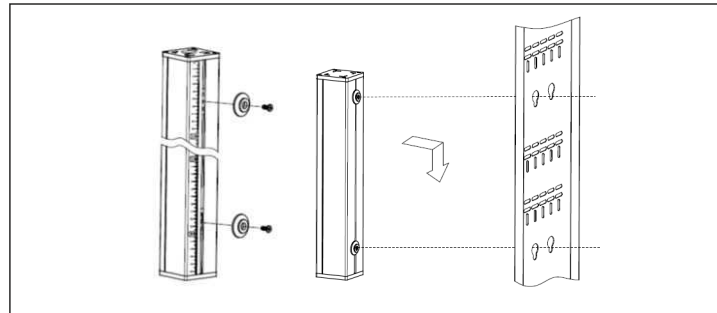
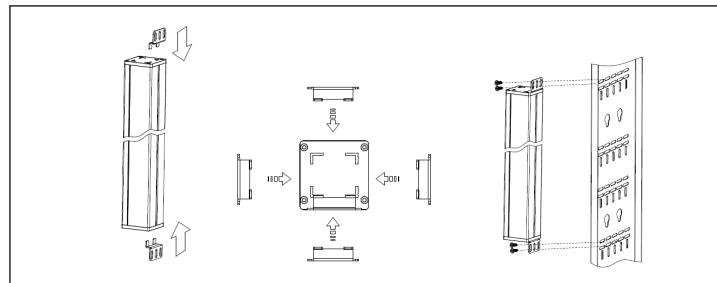

Introduction the SCHNEIKEL PDU

Hotswap replaceable IEX GIGA Controller

The GIGA IEX PDUs provides an easy replacement of its controller.

If the controller is failing, just simply send the controller back to Powertek for repair or replacement.

How to replace a controller:

1- PDU is not required to be powered off.

Loosen the screws at two sides of the IEX GIGA controller, and lift it up.

2- Disconnect the PDU's controller cable from the controller.

3- Get a new IEX GIGA controller and install it back into the PDU in the reverse order.

Note: the limit torque to fix the controller is 0.8N.m—1.0N.m

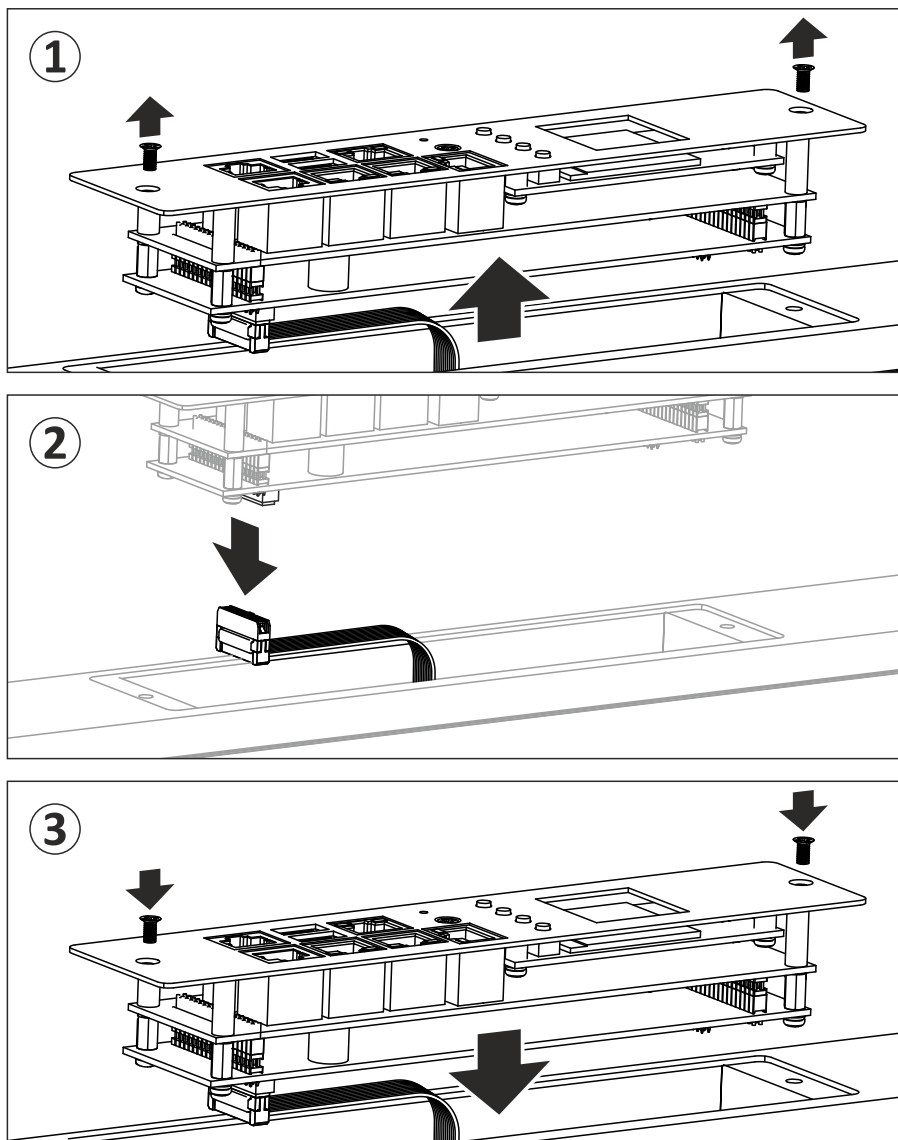

Getting Started

Making Connections

The Schneikel PDU is a versatile product that can be connected to several different types of input and output devices. This makes it a useful tool for connecting devices to it and to monitor the power through its user interface.

IEVx.5 PDU is manufactured with the most advanced hot-swap, field replaceable SNMP IP controller. It is built with dual Gigabit Ethernet ports, an OLED full colour screen, cascading multi-sensor ports, enhanced security, sophisticated alarming and power monitoring across the whole power chain.

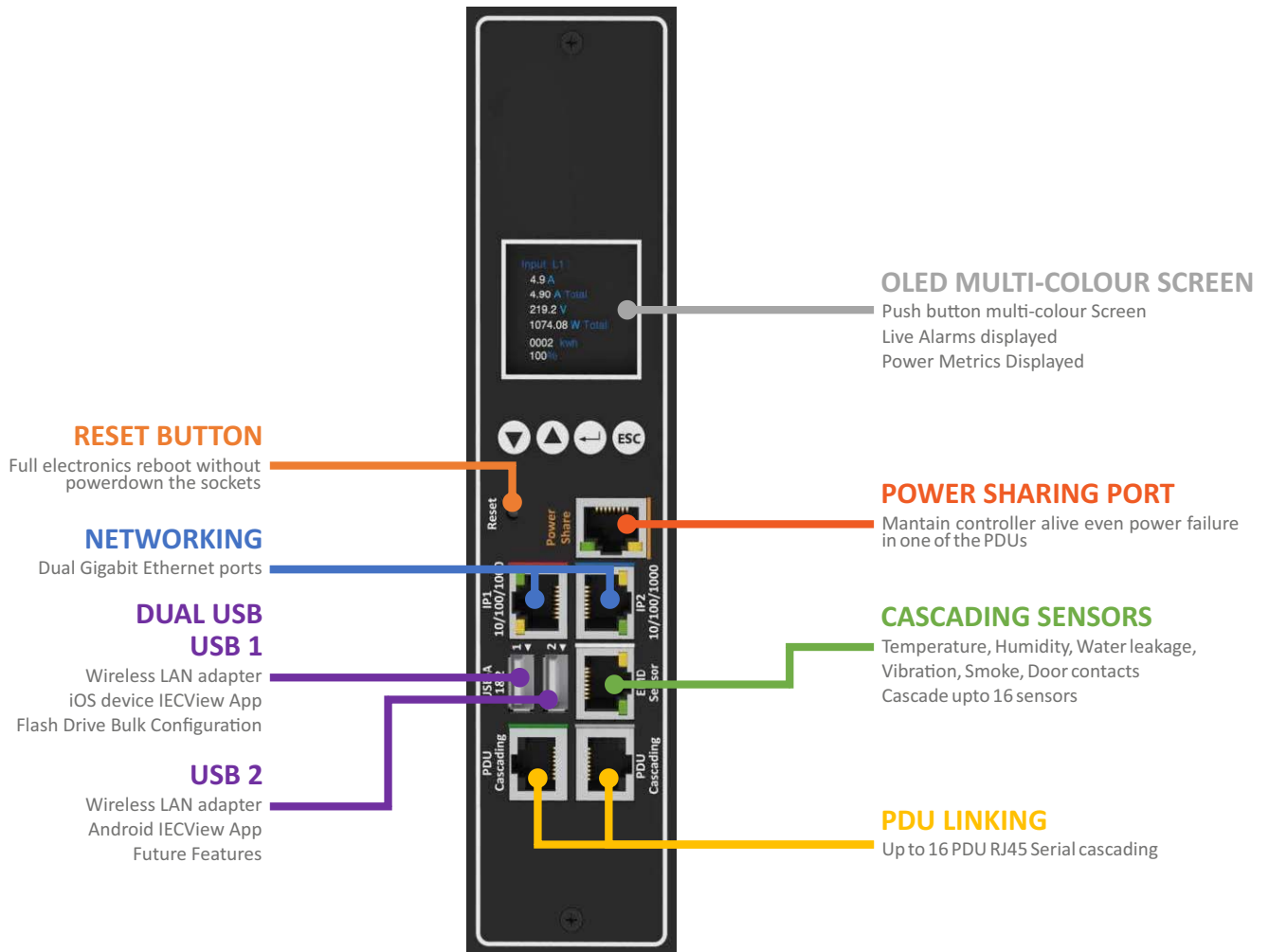

Getting Started

The following procedure describes the basic steps needed to set up the PDU:

1. To set up the hardware, connect power to the power inlet and output devices to the power outlets. Connect devices with normally open or normally close conditions to the digital output ports, and an EMD31 to the console port.
2. To configure the Power Strip, users can use the console or LAN port. Connect the device to a console and a LAN to enable its configuration through the console or browser menu.
3. After connecting to a console, use a console application such as HyperTerminal to access the console menu. Select the TCP/IP under the Network Management to set up the IP address and select the General Setting submenu under the System Management to set up the system date/time. This IP address will be used while accessing the web interface to configure the SCHNEIKEL PDU parameters.
4. After connecting to LAN, open a browser from a PC in the network and use the IP address specified through the console menu to open the web interface for system configuration.

The following sections provide instructions about how to make various connections.

Connecting Output Devices

The Power strips can have a different number of outlets for connecting devices such as workstations, servers, and printers. Connect the power connectors of the devices to each of the power outlets.

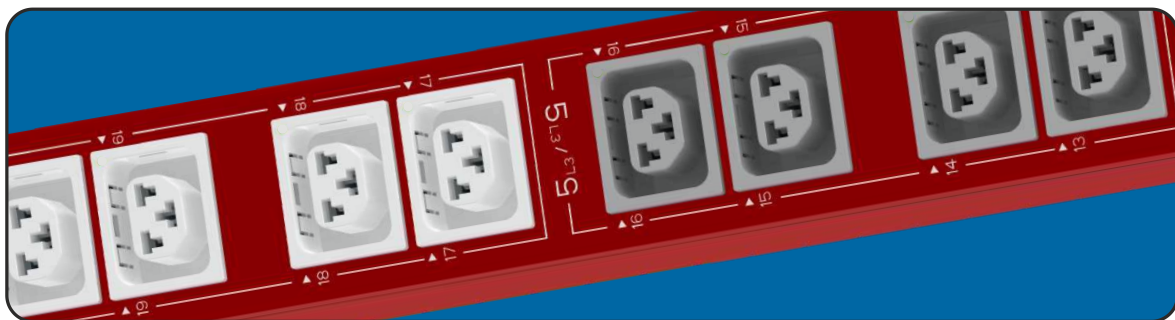

The SCHNEIKEL PDU's are available in the following sockets:

220V/16A: IEC C13/C19 combo

220V/10A: IEC C13, IEC C13 (Lock), AS/NZS 3112

220V/16A: SEV T13, SEV T23, CEE7, IEC C19, IEC C19 (lock), SEV T23

220V/13A: UK BS1363

220V/15A: AS/NZS 3112

120V/15A: NEMA 5-15P

120V/20A: NEMA5-20P

Getting Started

Connecting EMD31

An Environmental Monitoring Device (EMD31) that is connected to sensors for detecting temperature, humidity, and two digital inputs can be connected to the SCHNEIKEL PDU with the console port. The EMD31 can also be connected to alarms or indicators and controlled through the web browser. Up to 8 EMD31 can be connected in cascade to monitor the temperature and humidity in different parts of the racks.

1. Connect the EMD31 to the console port as shown:

After connecting the EMD31, open a web browser from a PC and enable environmental sensors on the web user interface, then the temperature and humidity status is automatically displayed on the System Overview page.

Monitors the status of two user-provide contact devices to protect your critical equipments.

Two additional digital input sensor devices can be connected to the EMD31 and monitored.

* Addi on sensor devices include:

- > Motion detector
- > Smoke detector
- > Vibration detector
- > Water Leak detector
- > Universal (any device with normally-open or closed)

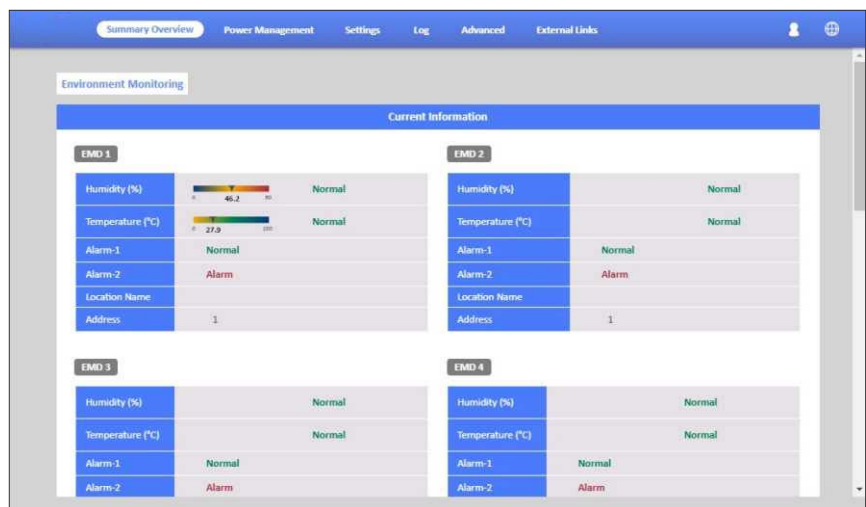

Dip-Switch for adress setting

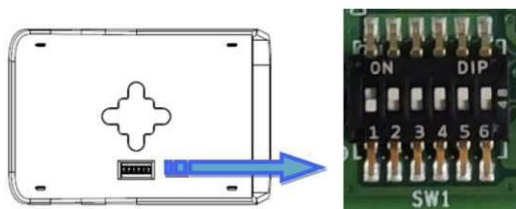

Pin	Function	120 Ω enable	120 Ω disable
6	120 Ω enable	On	Off

Pin 6 function define

Pin 1	Pin 2	Pin 3	Pin 4	Pin 5	MODBUS Address	Switch State
ON	OFF	OFF	OFF	OFF	1	
OFF	ON	OFF	OFF	OFF	2	
ON	ON	OFF	OFF	OFF	3	
OFF	OFF	ON	OFF	OFF	4	
ON	OFF	ON	OFF	OFF	5	
OFF	ON	ON	OFF	OFF	6	
ON	ON	ON	OFF	OFF	7	
OFF	OFF	OFF	ON	OFF	8	

Getting Started

Digital input sensors are connected to the dry of the EMD31, enable them as picture below. You can name them to know in case of an event from which sensor comes from.



Daisy Chain setting

Step 1: To set up the Daisy chain, connect a RJ45 patch cord from Cascading port OUT)Master PDU to Cascading port IN (Slave PDU) a maximum of 15 Slave PDUs are permitted.

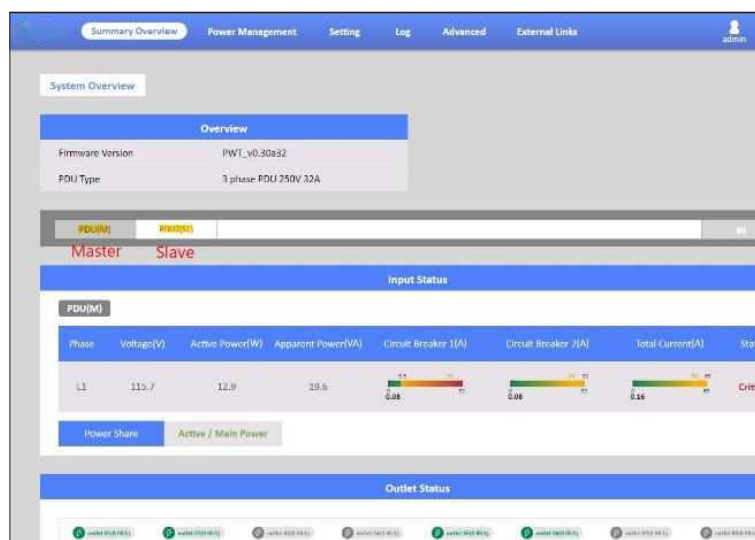
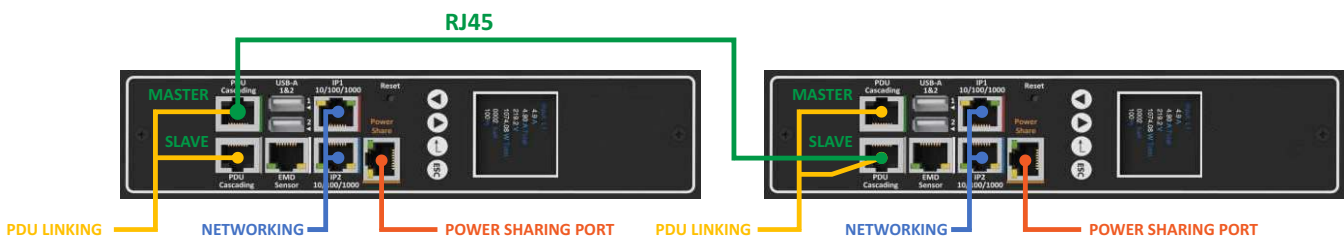

Getting Started

Connecting the Power Share adaptor and cable.



USE ON ONE OF THE ENDS THE ORANGE RJ45 ADAPTOR SUPPLIED ON THE PDU PACKING, A STANDARD TIA/EIA568 PATCH CORD IS NEEDED TO CONNECT BOTH PDUS

Step 1: To set up the PDU, connect the Power Share adaptor (orange color) in the Power Share port of one of the PDUS (PDU A) then a standard patch cord from this to PDU B.

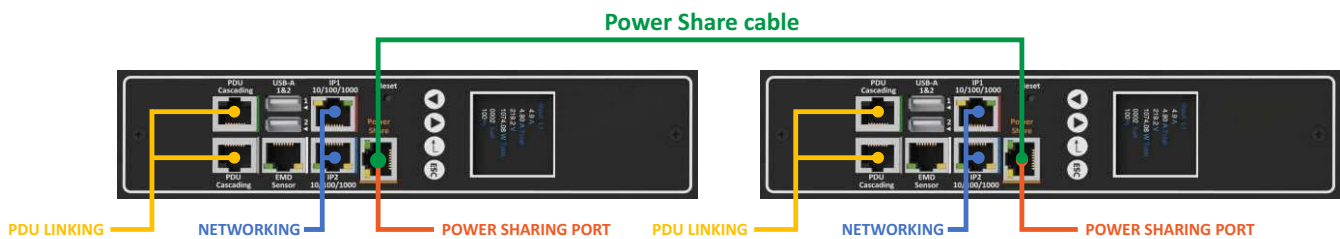

Step 2: After connect the patch cable, open a web browser from a PC, then the status of the power share is automatically displayed on the **System Overview** webpage. If PDU A is master PDU then the status of power share will display **Active/Main Power** on the **System Overview** webpage.

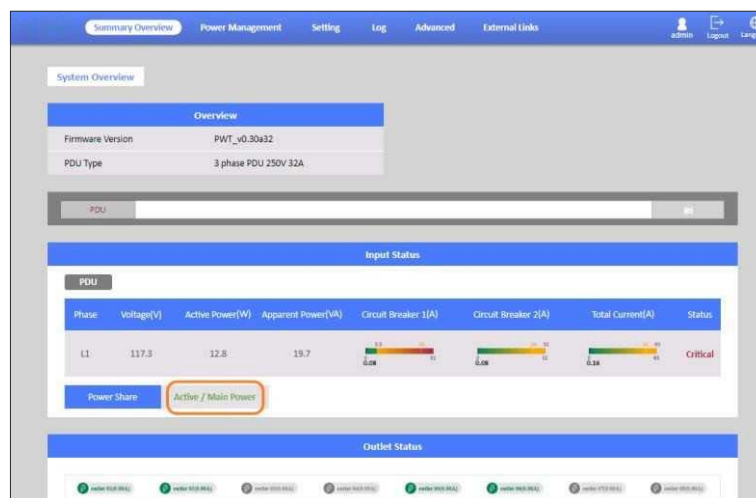

Getting Started

Step 3: When PDU A has utility power fail, the status of power share will display **Active/Backup Power** on the **System Overview** webpage.

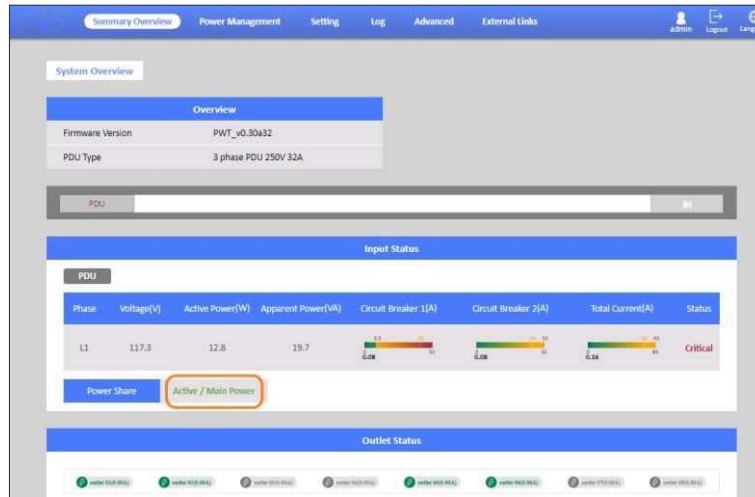

Step 4: At the same, the information of inlet phase load management will not display on the Inlet **Configuration** of the **Power Management** webpage.

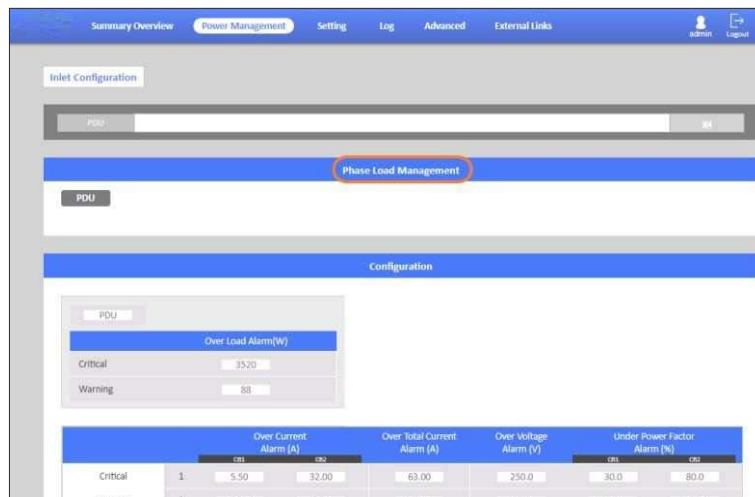

Step 5: Another, there are some outlets information will not display on the **Outlet Control** of **Power Management** webpage.



Getting Started

Step 6: The related alarm will be occurred on the **Alarm List of Summary Overview** webpage. The alarm will be “PDU (PDU:1) power off”.

Alarm List		
Number of Active Alarms : 4		
Alarm ID	Alarm Time	Alarm Description
56	22/02/2022 11:09:14	Inlet (PDU:1) phase1 pf branch2 was lower than warning set point
57	22/02/2022 11:09:14	Inlet (PDU:1) phase1 pf branch2 was lower than critical set point
3	22/02/2022 13:45:26	(PDU:1) EMD1(EMD-1) temperature was higher than high warning set point
62	24/02/2022 10:22:17	PDU (PDU:1) power off

Step 7: The related log and trap will be recorded on the **Log of Event Log** webpage and NMS. The log and trap will be “warning: Inlet (PDU:1) Acv e/Main Power change to Acv e/Backup Power”.

Event Log		
From:	24/02/2022	To: 24/02/2022
Device:	All	Event Level: Information
<input type="button" value="Apply"/> <input type="button" value="Clear All"/>		
Show	10	entries per page
Date&Time	Event Level	Event Description
24/02/2022 10:22:18	Information	Inlet (PDU:1) phase1 voltage had returned from warning to normal
24/02/2022 10:22:17	Warning	Inlet (PDU:1) Active/Main Power change to Active/Backup Power
24/02/2022 09:57:29	Warning	Inlet (PDU:1) phase1 voltage was higher than warning set point
24/02/2022 09:57:28	Information	Inlet (PDU:1) Active/Backup Power change to Active/Main Power
24/02/2022 09:45:17	Information	Inlet (PDU:1) phase1 voltage had returned from warning to normal

pduInletPowerShareMainLose			
Source:	172.31.34.249	Timestamp:	3703 hours 53 minutes 34.67 seconds
Trap OID:	pduInletPowerShareMainLose	SNMP Version:	2
Variable Bindings:		Community:	public
Name:	.1.3.6.1.2.1.1.3.0		
Value:	[TimeTicks] 3703 hours 53 minutes 34.67 seconds (1333401467)		
Name:	snmpTrapOID		
Value:	[OID] pduInletPowerShareMainLose		
Name:	pduTraps		
Value:	[OctetString] Inlet (PDU:1) Active/Main Power change to Active/Backup Power		
Description:	Warning Active/Main Power change to Active/Backup Power		

Getting Started

Step 8: When PDU A has utility power restore, the status of power share will display **Active/Main Power** on the **System Overview** webpage.

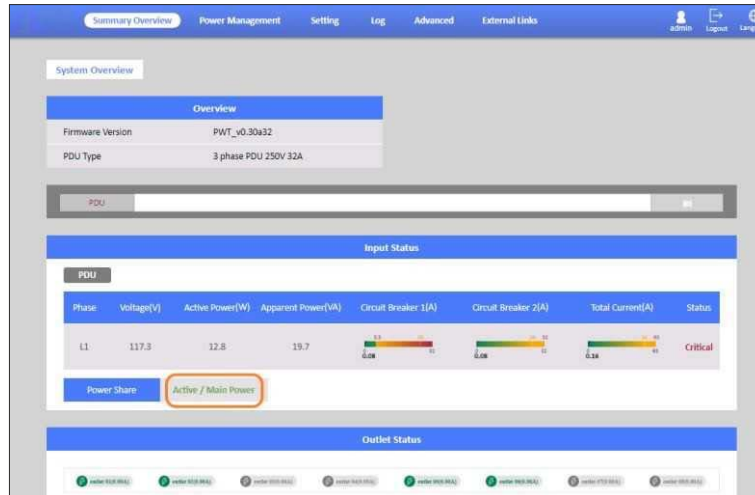

Step 9: The related log and trap will be recorded on the **Log of Event Log** webpage and NMS. The log and trap will be "Information: Inlet (PDU:1) Active/Backup Power change to Active/Main Power".

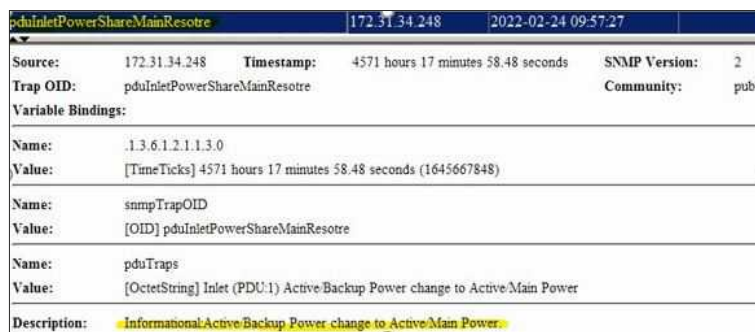
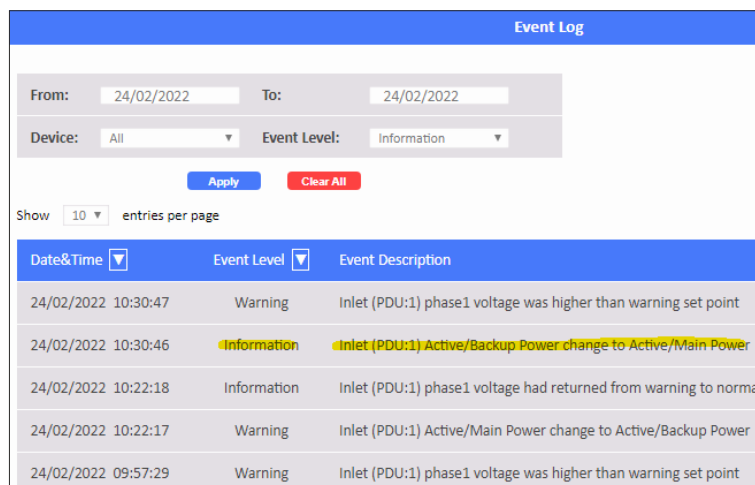

Getting Started

Step 10: When user remove power sharing cable, the status of power share will display **Inactive** on the **System Overview** webpage.

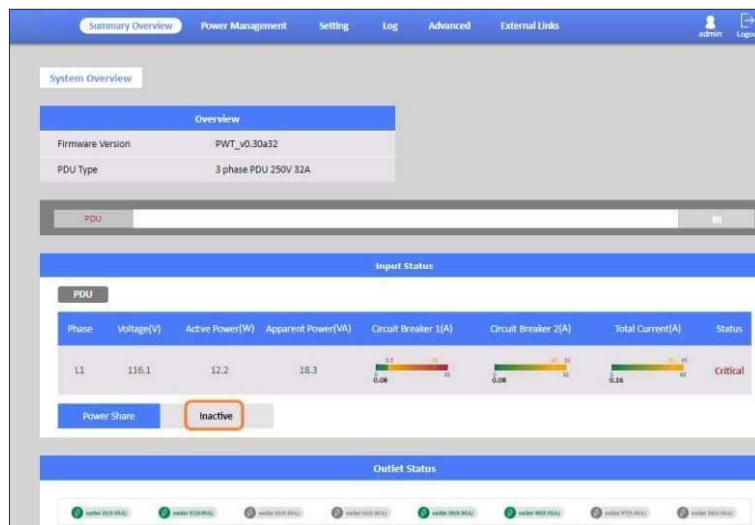
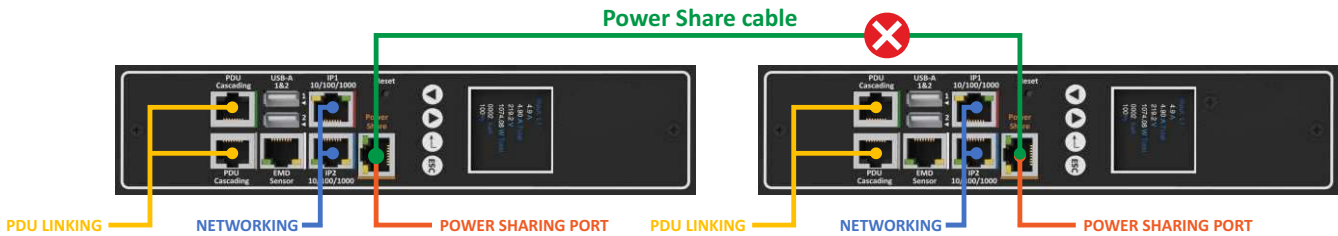

Step 11: The related alarm will be occurred on the **Alarm List** of **Summary Overview** webpage. The alarm will be “PDU Power Share disconnected”.

Alarm List		
Number of Active Alarms : 4		
Alarm ID	Alarm Time	Alarm Description
56	22/02/2022 11:09:14	Inlet (PDU:1) phase1 pf branch2 was lower than warning set point
57	22/02/2022 11:09:14	Inlet (PDU:1) phase1 pf branch2 was lower than critical set point
37	24/02/2022 10:30:48	Inlet (PDU:1) phase1 voltage was higher than warning set point
63	24/02/2022 10:55:45	PDU [PDU:1] Power Share disconnected

Getting Started

Step 12: The related log and trap will be recorded on the **Log of Event Log** webpage and NMS. The log and trap will be “Warning: Inlet (PDU:1) Active/Main Power change to Inactive”.

Event Log		
From:	24/02/2022	To: 24/02/2022
Device:	All	Event Level: Information
<input type="button" value="Apply"/> <input type="button" value="Clear All"/>		
Show	10	entries per page
Date&Time	Event Level	Event Description
24/02/2022 10:55:45	Warning	Inlet (PDU:1) Active/Main Power change to Inactive
24/02/2022 10:55:34	Information	(PDU:1) EMD1(EMD-1) temperature had returned from high warning to normal

pduInletPowerShareBackupLose		172.31.34.248	2022-02-24 10:30:45
Source:	172.31.34.248	Timestamp:	4571 hours 18 minutes 18.46 seconds
Trap OID:	pduInletPowerShareBackupLose	SNMP Version:	3 (EngineID: 0x80001F8880213)
Variable Bindings:		User:	test1234
Name:	.1.3.6.1.2.1.1.3.0		
Value:	[TimeTicks] 4571 hours 18 minutes 18.46 seconds (1645669846)		
Name:	snmpTrapOID		
Value:	[OID] pduInletPowerShareBackupLose		
Name:	pduTraps		
Value:	[OctetString] Inlet (PDU:1) Active/Backup Power change to Active/Main Power		
Description:	Warning:Active/Main Power change to Inactive.		

Getting Started

Connecting to a LAN/WAN

The PDU has two 10/100/1000 RJ-45 network ports that enables to monitor and manage the power outlets over the network. The PDU has a graphic user interface that allows users to control the device through a web browser.

Connect the device to a free port on the router using an Ethernet cable as shown. Users can control the device from PC, laptop, mobile phone, or PDA which is connected to the router network.

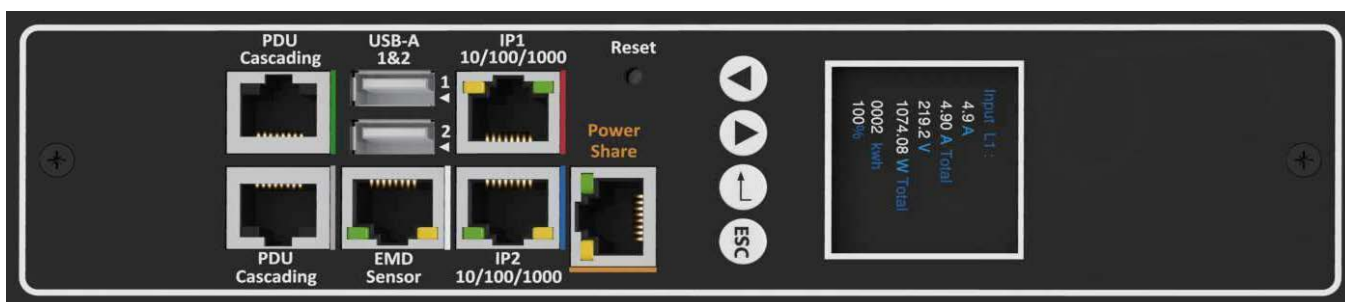

Getting Started

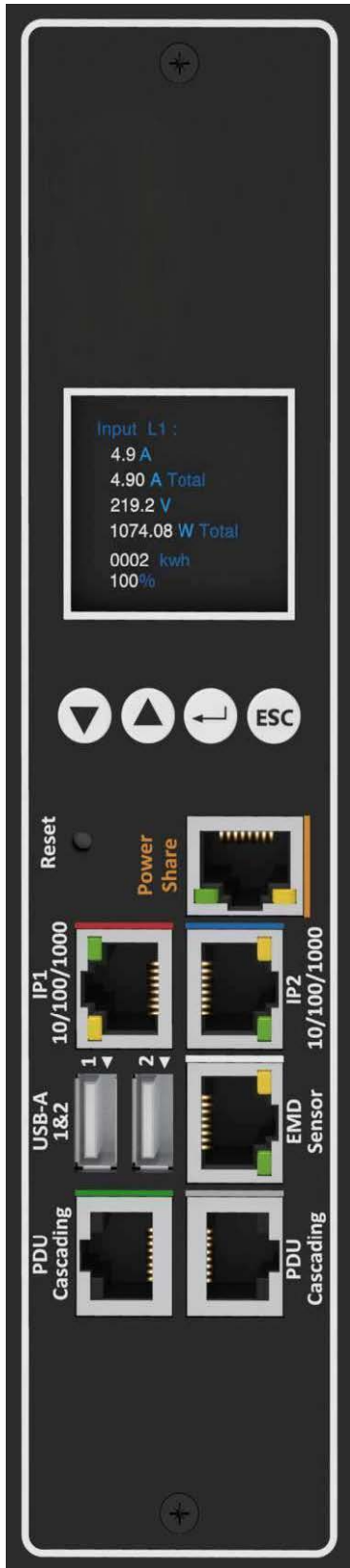

Using LCM operational buttons:

The following sections describe the LCM functional operation of the PDU.

The PDU has four buttons to launch particular applications and display the on-screen.

Icon	Button	Description
	Down	Press the Down button to navigate through the menu options.
	Up	Press the Up button to navigate through the menu options.
	Set	Press the Set button to access the menu options and confirm user selection.
	ESC	Press the ESC button to cancel any configuration or leave to up menu.

There are two kinds of LCM operation screen for the single and three phase as shown following.

User can configure the Screen Direction, of this PDU from the buttons. Regarding to turn on/off outlet, if this PDU has support network function, user can set the whole outlet configuration from **Outlet Control** webpage. The **Outlet Control** page displays.

Getting Started

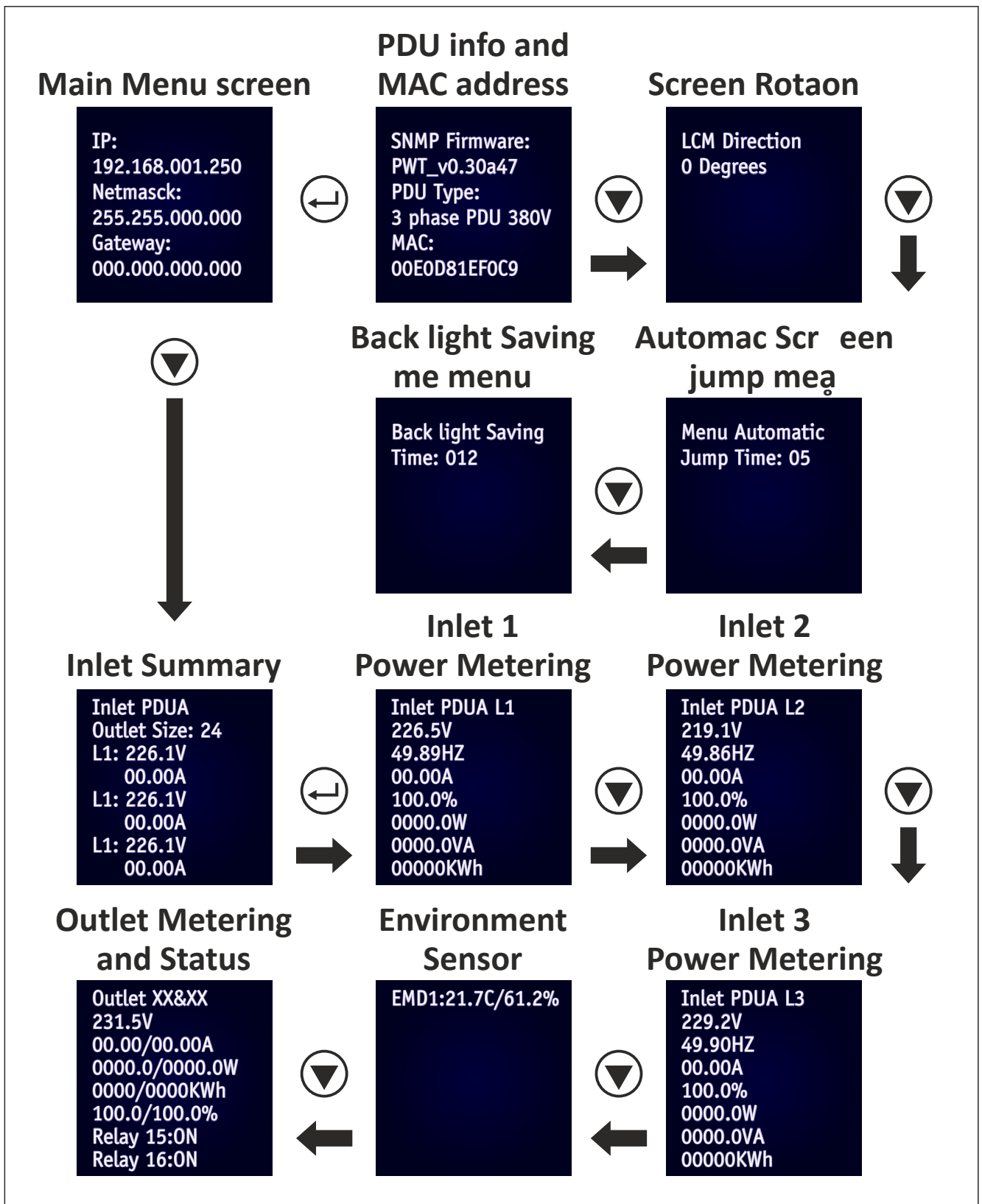

Getting Started

(RCM) Residual Current Monitoring Option:

When PDUs use the residual current device and detect a Residual current, the OLED screen keep flashing and display the “WARNING” signal as shown.



Users can set the related setting of residual current from the Inlet Configuration webpage as shown.

1. Alarm there holds a setting range for 3mA to 50mA, There holds default setting is 20mA, when residual current greater than or equal to threshold value,an alarm is triggered.
2. When DC residual current is greater than or equal to 5mA,an alarm is triggered.
3. When AC residual current is greater than or equal to 20mA,an alarm is triggered.
4. When the alarm threshold value setting is less than or equal to 5mA, If DC residual current or AC residual are active, an alarm is triggered.
5. When the alarm threshold value setting is less than or equal to 20mA, If AC residual current is active, an alarm is triggered and DC residual current will be ignored.

The screenshot displays the 'Inlet Configuration' page for a PDU. The 'Phase Load Management' section is active, showing a table of phase data and a residual current status indicator.

Phase	Current(A) Total(CB1/CB2)	Voltage(V)	Frequency (Hz)	Power Factor (CB1/CB2)	Power(W/VA) Active/Apparent	Reactive Power (var)	Status
1	0.02(0.00/0.02)	223.5	49.91	1.00/1.00	4.4/4.4	0.0	Normal

Below the table, the 'Residual Current (mA)' is shown as '--- Critical'.

Getting Started

(SPD) Surge Protection Monitoring Option:

When PDUs use the replaceable surge protection and detect an Overvoltage, the OLED screen keep flashing and display the “WARNING” signal as shown, also an alarm will be displayed on the graphic user interface.



Surge characteristics: Single phase

Type		BT PCM20 TT1+1 275 RM-1
Art.-No.		870 114
Nominal a.c. voltage	U_n	230V~
Rated voltage (max. continuous voltage)	U_c	275V~(L-N); 255V~(N-PE)
Nominal discharge current (8/20)	I_n	10kA (L-N); 20kA (N-PE)
Max. discharge current (8/20)	I_{max}	20kA (L-N); 40kA (N-PE)
Voltage protection level at I_n	U_p	$\leq 1.0kV$ (L-N); $\leq 1.25kV$ (N-PE)
Voltage protection level at 3kA	U_p	$\leq 0.8kV$ (L-N)
Response time	t_h	$\leq 25ns$ (L-N); $\leq 100ns$ (N-PE)
Max. back up fuse		125A gL/gG
Operating temperature range	T_a	-40°C...+80°C
Cross-section area (L/N)		1.5mm ² ~ 10mm ² solid / flexible
Cross-section area (PE)		6,0mm ² ~ 25mm ² solid / flexible
Mounting on		35mm DIN rail
Enclosure material		Light grey thermoplastic, UL94-V0
Dimension		1 mod
Test standards		IEC 61643-11; EN 64643-11
Certification		CE(LVD, EMC)
Type of remote signalling contact		Switching contact
Switching capacity	U_p/I_n	AC:250V/0,5A DC:250V/0,1A,125V/0,2A,75V/0,5A
Cross-sectional area for remote signalling contact		Max. 1.5mm ² solid / flexible

Three phase

Type		BT PCM20 TT3+1 275 RM-1
Art.-No.		870 154
Nominal a.c. voltage	U_n	230V~
Rated voltage (max. continuous voltage)	U_c	275V~(L-N); 255V~(N-PE)
Nominal discharge current (8/20)	I_n	10kA (L-N); 20kA (N-PE)
Max. discharge current (8/20)	I_{max}	20kA (L-N); 40kA (N-PE)
Voltage protection level at I_n	U_p	$\leq 1.0kV$ (L-N); $\leq 1.25kV$ (N-PE)
Voltage protection level at 3kA	U_p	$\leq 0.8kV$ (L-N)
Response time	t_h	$\leq 25ns$ (L-N); $\leq 100ns$ (N-PE)
Max. back up fuse		125A gL/gG
Operating temperature range	T_a	-40°C...+80°C
Cross-section area (L/N)		1.5mm ² ~ 10mm ² solid / flexible
Cross-section area (PE)		6,0mm ² ~ 25mm ² solid / flexible
Mounting on		35mm DIN rail
Enclosure material		Light grey thermoplastic, UL94-V0
Dimension		2 mod
Test standards		IEC 61643-11; EN 64643-11
Certification		CE(LVD, EMC)
Type of remote signalling contact		Switching contact
Switching capacity	U_p/I_n	AC:250V/0,5A DC:250V/0,1A,125V/0,2A,75V/0,5A
Cross-sectional area for remote signalling contact		Max. 1.5mm ² solid / flexible

Using the Web Interface

The SCHNEIKEL PDU provides a graphic user interface that can be viewed from a web browser such as Internet Explorer. This enables users to access and control the device outlets and subsequently, its output devices remotely from users' desktop, laptop, PDA, or even users' mobile phones. This section provides instructions about how to use the web interface to configure and control the PDU remotely.

Summary Overview-System Overview

Start a web browser such as Internet Explorer from the host PC or laptop and enter the IP address of the Power Strip in the address bar. For details about setting the IP address of the system. You will be prompted to enter a Username and Password. Click Go and the main status page of the SCHNEIKEL PDU web interface is displayed.

The default settings are:

DHCP: Enabled

IP Address: 192.168.1.250

Subnet Mask: 255.255.255.0

Gateway: 192.168.1.10

Username: admin

Password: admin

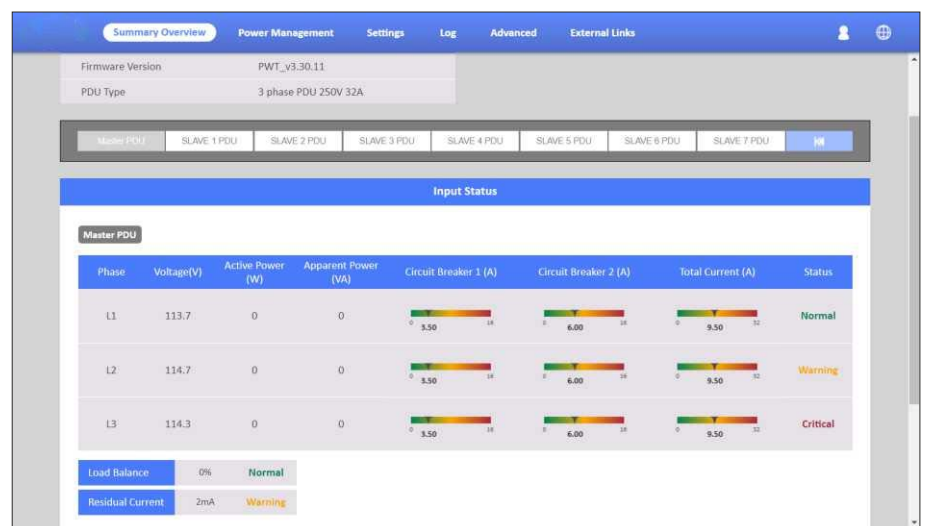

The main page shows a graphic representation of the Power Strip outlets and inputs status as described below:

- The panel shows the various menus and submenus. Click any menu to display the menu options, expand the menu items, and modify the menu options as required.
- The right panel shows the current status of the Power strip.

Using the Web Interface

Summary Overview-Alarm List

The “Alarm List” page shows the list of Alarms, which were set by the user. SCHNEIKEL PDU will follow the rules of an alarm to send out notification to the user.

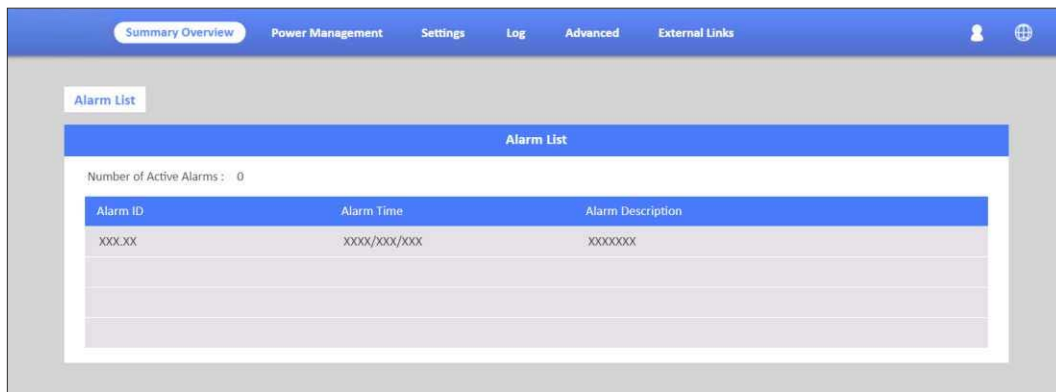

The screenshot shows the 'Alarm List' page. At the top, there is a navigation bar with 'Summary Overview' selected, and other options: 'Power Management', 'Settings', 'Log', 'Advanced', and 'External Links'. Below the navigation bar, there is a sub-header 'Alarm List'. Underneath, it says 'Number of Active Alarms : 0'. A table with three columns is displayed: 'Alarm ID', 'Alarm Time', and 'Alarm Description'. The table contains one row with placeholder text: 'XXX.XX', 'XXXX/XXX/XXX', and 'XXXXXXXX'.

Alarm ID	Alarm Time	Alarm Description
XXX.XX	XXXX/XXX/XXX	XXXXXXXX

Summary Overview-Network Connection

The Network Connection page shows a list of user's connections.

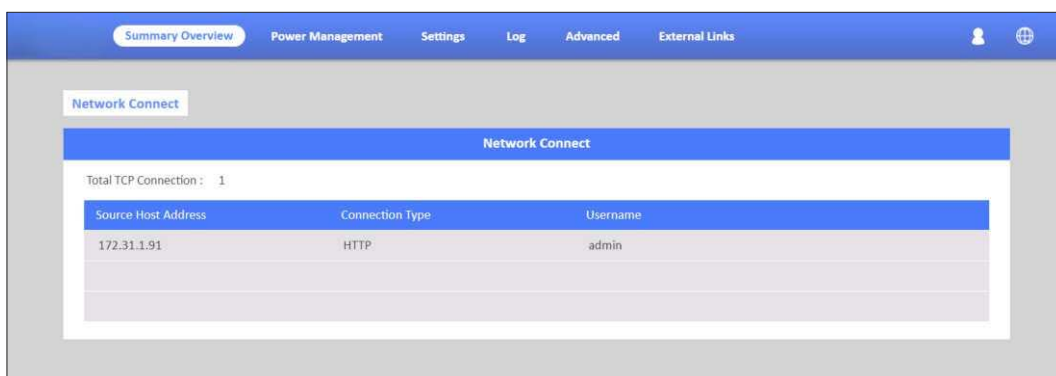

The screenshot shows the 'Network Connect' page. At the top, there is a navigation bar with 'Summary Overview' selected, and other options: 'Power Management', 'Settings', 'Log', 'Advanced', and 'External Links'. Below the navigation bar, there is a sub-header 'Network Connect'. Underneath, it says 'Total TCP Connection : 1'. A table with three columns is displayed: 'Source Host Address', 'Connection Type', and 'Username'. The table contains one row with data: '172.31.1.91', 'HTTP', and 'admin'.

Source Host Address	Connection Type	Username
172.31.1.91	HTTP	admin

Using the Web Interface

Outlet Sequential Startup

To prevent inrush currents the Schneider PDU use a time delay sequence between each outlet, this happens once PDU is POWER ON for first time as well as in case of accidental or equipment maintenance POWER OFF. By default the PDU turns ON all the outlets that were ON before POWER OFF. As a second option in case is required you can choose to turn all the outlet OFF once POWER ON again.

Outlet ID	Outlet Name	Current	Power (W/VA) Active/Apparent	Full Power Monitor	Action	State	Status
1	outlet 01	0.00	0.0/0.0	Detail	No Action ▾	ON	Normal
2	outlet 02	0.00	0.0/0.0	Detail	No Action ▾	ON	Normal

Power Management-Inlet Configuration

This page lets the user configure Inlet load. You can set the condition of "Critical" and "Warning". (The value of "Critical" must be larger than "Warning").

When Inlet Power is over the condition you set, the light of status will become the corresponding colour. (Red means "Critical", Yellow means "Warning" and Green means "Normal") And you will receive the notification mail if you have set it in Email Notification.

Phase	Current(A) Total(CB1/CB2)	Voltage(V)	Frequency (Hz)	Power Factor(%)	Power(W/VA) Active/Apparent	Reactive Power (var)	Status
1	0.00(0.00/0.00)	112.7	59.92	0.0	0.00	0.0	Normal
2	0.00(0.00/0.00)	113.4	59.90	0.0	0.00	0.0	Warning
3	0.00(0.00/0.00)	113.0	59.90	0.0	0.00	0.0	Critical

		Over Current Alarm (A)		Over Total Current Alarm (A)	Over Voltage Alarm (V)
		CB1	CB2		
Critical	1	16	16	32	250
	2	16	16	32	250
	3	16	16	32	250
Warning	1	16	16	32	250
	2	16	16	32	250
	3	16	16	32	250

Using the Web Interface

Power Management-Outlet Control

This page let user trigger action by drop-down list. After you select an action and click "Apply", server will accord to the instruction to complete the task remotely.

Click "See Details" to open the page as shown:

In this page, you can set "How many seconds delay" when Power ON/OFF Delay action are triggered.

You can also set the seconds of "Reboot Duration".



After set, you can click "Apply" to apply to this Outlet or click "Apply to All Outlet" to make this setting apply to all Outlets.

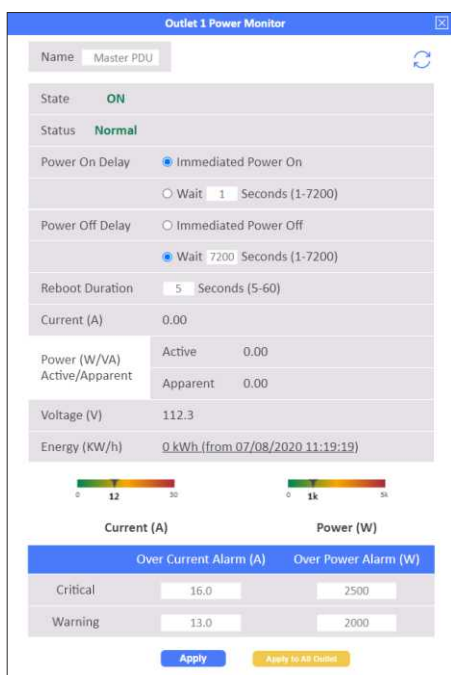

Take Outlet4 for example (Set Power ON/OFF Delay=3 seconds /Reboot Duration=10 seconds), when you select Action "Off Delay" and click Apply. Outlet4 will power off after 3 seconds.

If you select Action "Power Cycle Immediate" and click Apply, Outlet4 will reboot and this procedure will cost 10 seconds.

If you select Action "Power Cycle Delay" and click Apply, Outlet4 will reboot and this procedure will cost 16 seconds.(Include 3 seconds for "Power ON Delay", 3 seconds for "Power Off Delay" and 10 seconds for "Reboot Duration").

Using the Web Interface

Power Management-Outlet Grouping

This page shows the group list and let user enable Outlet Group.

User can add/delete/modify the group list. The group list is up to 8 groups. Take Group_1 for example, I have set Outlet_1 of PDU_A, Outlet_3 of PDU_B and Outlet_4 of PDU_C into Group_1. When I set action to Outlet_3 of PDU_B and apply, Action will apply to all PDUs of Group1.

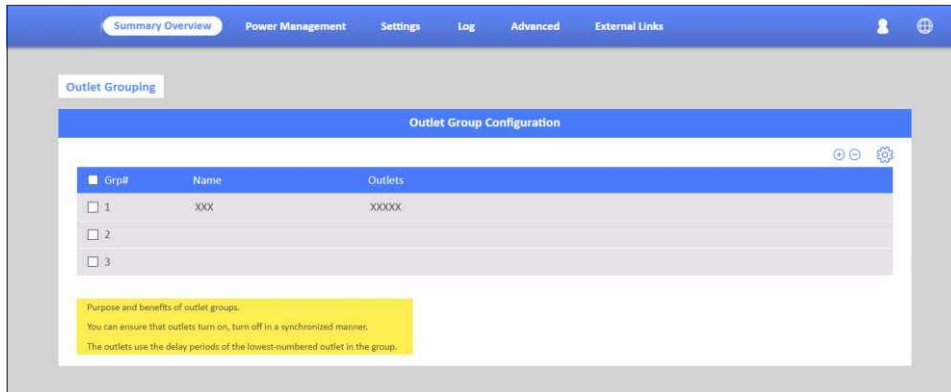

Power Management-Outlet Schedule

Outlet Schedule function allows to Schedule an action to the desired outlet or group of outlets daily, weekly or one time action.

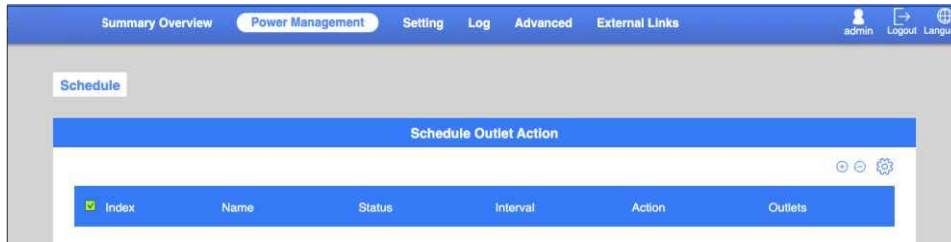

Click “+” and the menu with action options and outlets will appear, then choose your desired action, date and time.

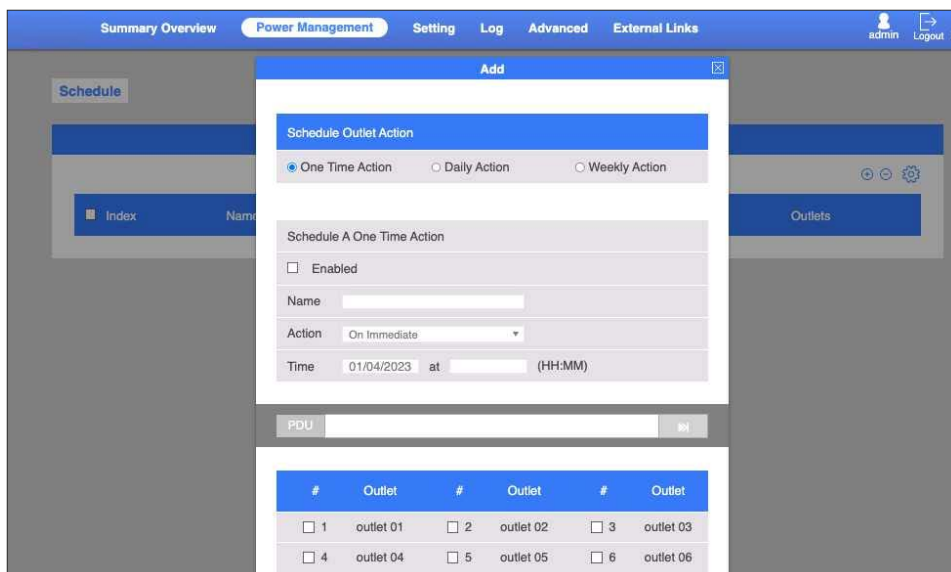

Using the Web Interface

Power Management-Environment Monitoring

This page shows the status of EMD31 and lets users set the alarm configuration. You can set the "Alarm Condition" of "Critical" and "Warning". (The value of "Critical" must be larger than "Warning") It will follow the Email Notification rule you set to send out mails.

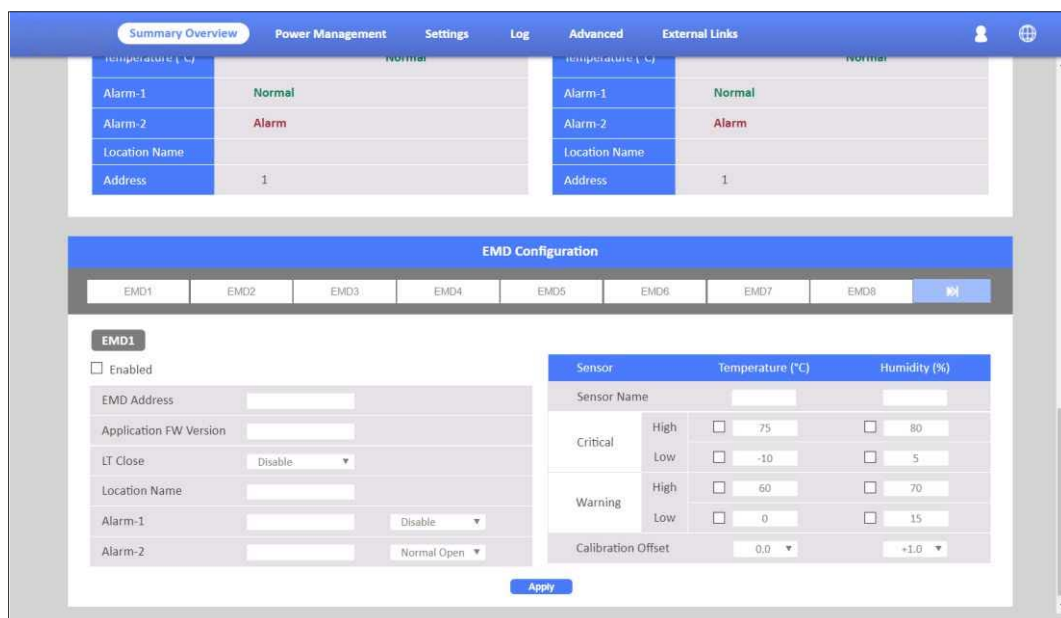
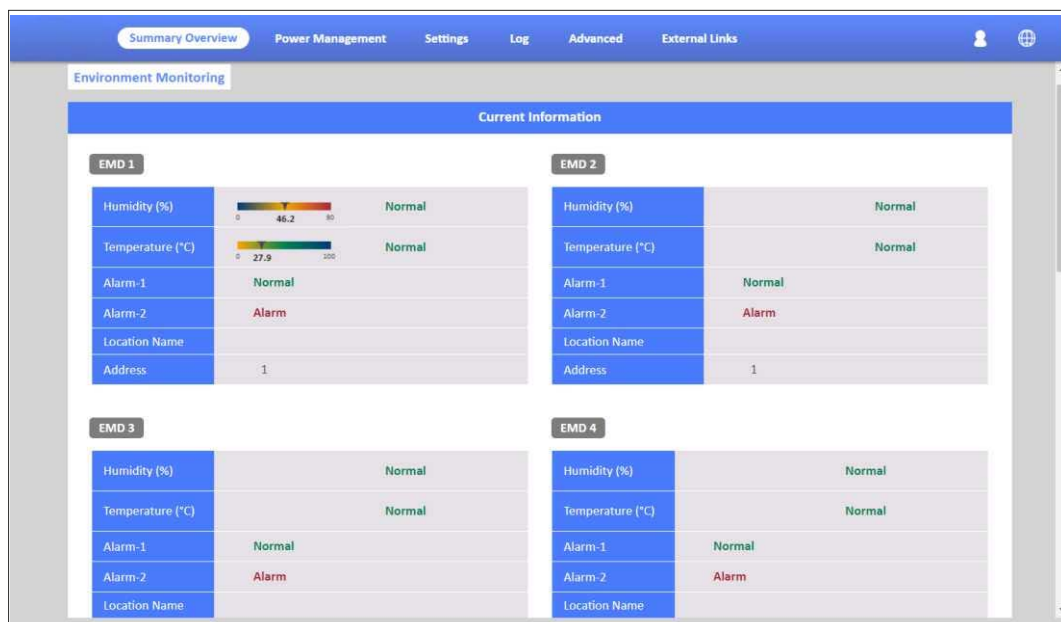

SCHNEIKEL PDU supports 8 EMD sensors in cascade each one with 2 digital inputs to set 2 alarms for each EMD 31 sensor. There are 3 options(Normal Open/Normal Close/Disable) of the EMD sensor. If you set "Normal Open", the EMD sensor will become "Warning"(Yellow light) when closed.

Using the Web Interface

Setting – General Setting

This page let users setup the system administration and date and time.

The screenshot shows the 'General Setting' page. At the top, there is a navigation bar with 'Summary Overview', 'Power Management', 'Setting' (highlighted), 'Log', 'Advanced', and 'External Links'. On the right, there are 'Login' and 'Language' options. Below the navigation bar, the 'General Setting' section is divided into two main areas: 'System Administration' and 'Date and Time'. The 'System Administration' section contains a table with the following data:

System Name	Powertek
System Contact	sales@powertekpdus.com
System Location	
Log Interval	60
Web Refresh Interval (3 ~ 60)	15
Web Timeout Enabled	<input type="checkbox"/>
Web Timeout Interval (Sec)	300

The 'Date and Time' section contains a table with the following data:

Date and Time	14/04/2023 12:51:03
Time Zone	[GMT +01:00] Brussels, Copenhagen, Madrid, Paris
Date Format	dd/mm/yyyy

At the bottom of the 'Date and Time' section, there is a radio button labeled 'Manual Setting'.

Setting – TCP/IP

This page allow users to enable/Disable DHCP under IPv4 or enable IPv6.

The screenshot shows the 'TCP/IP' page. At the top, there is a navigation bar with 'Summary Overview', 'Power Management', 'Setting' (highlighted), 'Log', 'Advanced', and 'External Links'. On the right, there are 'Login' and 'Language' options. Below the navigation bar, the 'TCP/IP' section is divided into two main areas: 'IPv4 Setting' and 'IPv6 Setting'. The 'IPv4 Setting' section contains a table with the following data:

<input type="checkbox"/> Enabled DHCP	
IP address	192.168.124.2
Subnet Mask	255.255.255.0
Gateway Address	192.168.1.1
Primary DNS Server	192.168.1.1
Secondary DNS Server	255.255.255.0

The 'IPv6 Setting' section contains a table with the following data:

<input checked="" type="checkbox"/> Enabled IPv6	
Configuration	DHCPv6
IP address	
Prefix Length	
Router Address	:::0
Primary DNS Server	
Secondary DNS Server	

Using the Web Interface

Setting – Accesible IP Setting

This page allow users to enable accessible IP lists.



Setting – Network Acces Protection

This page lets the user set their network protection and upload SSL certificates.

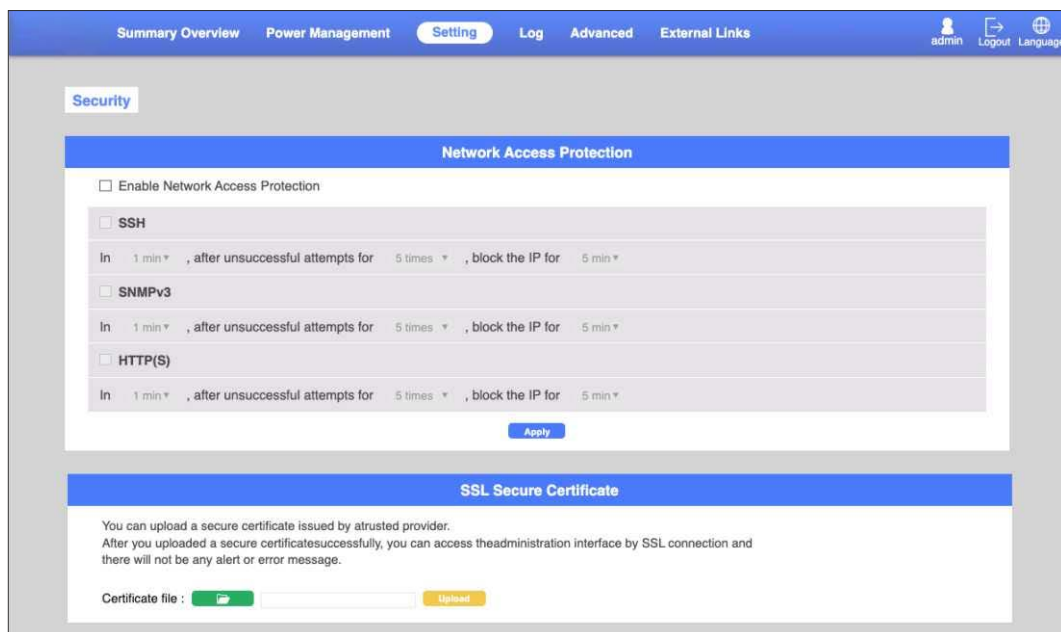

Using the Web Interface

Setting – Network Service

This page allows you to setup your network settings: SSH, MODBUS TCP/IP, SSL, LDAP, PING, RADIUS and TACACS+.

The screenshot shows the 'Network Service' configuration page. The page has a blue header with navigation tabs: 'Summary Overview', 'Power Management', 'Setting' (selected), 'Log', 'Advanced', and 'External Links'. On the right of the header, there are links for 'admin', 'Logout', and 'Language'. Below the header, the page title is 'Network Service'. The configuration is organized into several sections:

- SSH**:
 - Allow SSH Connection
 - Port Number: 22
- ModBus/TCP**:
 - Enabled ModBus/TCP
 - Port Number: 502
- SSL**:
 - Enabled Secure Connection(SSL)
 - Port Number: 443
 - Force Secure Connection(SSL) Only
 - Force Sign In
- Ping**:
 - Allow Ping Echo
- RADIUS Setting**:
 - Enabled RADIUS
 - Server IP Address: (empty)
- LDAP Setting**:
 - Enabled LDAP
 - Host: (empty)
 - Port Number: 389
 - TLS Connection:
 - Base DN: (empty)
- TACACS+ Setting**:
 - Enabled TACACS+
 - Host: (empty)
 - Port Number: 49
 - Secret Key: (empty)

Using the Web Interface

The second provides information about setting up the LDAP step by step.

Step 1: To set up the PDU, please configure the related LDAP parameters on the **Setting of Network Service** webpage as shown screen. For example, to enable LDAP, enter Host IP and Port Number...etc.



The screenshot shows the 'LDAP Setting' configuration page. It includes a checkbox for 'Enabled LDAP' which is checked. Below this are input fields for 'Host' (172.31.35.186), 'Port Number' (389), 'TLS Connection' (checked), and 'Base DN' (dc=qetest,dc=com).

LDAP Setting	
<input checked="" type="checkbox"/> Enabled LDAP	
Host	172.31.35.186
Port Number	389
TLS Connection	<input checked="" type="checkbox"/>
Base DN	dc=qetest,dc=com

Step 2: Please press “+” icon to add LDAP user then configure the related LDAP parameters on the **Setting of User Setting** webpage as shown screen. For example, set LDAP Username, select Privilege to “Outlet Manager” and select the related outlets.

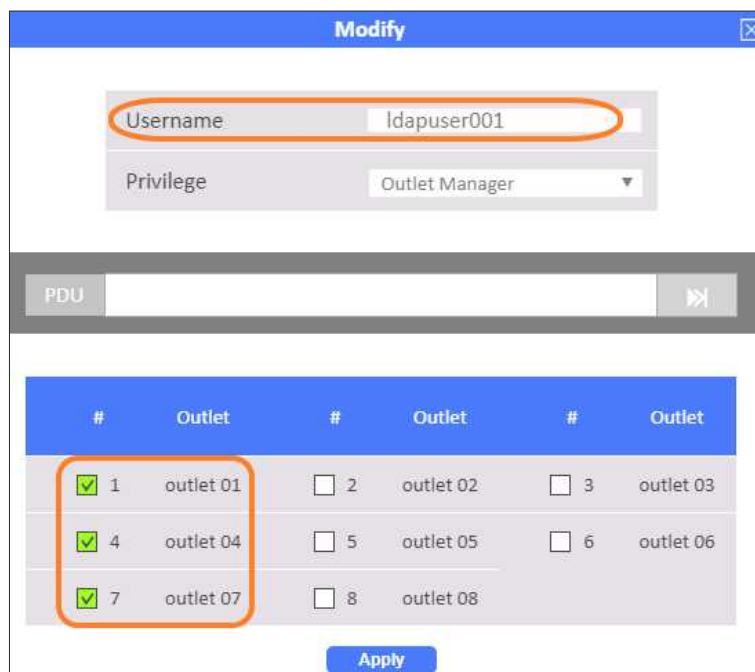

The screenshot shows the 'Modify' user setting page. The 'Username' field is highlighted with an orange circle and contains 'ldapuser001'. The 'Privilege' dropdown is set to 'Outlet Manager'. Below this is a 'PDU' field with a right arrow icon. At the bottom, there is a table of outlets with checkboxes for selection. Outlets 1, 4, and 7 are checked and highlighted with an orange circle. An 'Apply' button is at the bottom.

#	Outlet	#	Outlet	#	Outlet
<input checked="" type="checkbox"/> 1	outlet 01	<input type="checkbox"/> 2	outlet 02	<input type="checkbox"/> 3	outlet 03
<input checked="" type="checkbox"/> 4	outlet 04	<input type="checkbox"/> 5	outlet 05	<input type="checkbox"/> 6	outlet 06
<input checked="" type="checkbox"/> 7	outlet 07	<input type="checkbox"/> 8	outlet 08		

Apply

Using the Web Interface

Step 3: After configured LDAP parameter, please logout and close web browser. To enter LDAP username and password then login web browser.

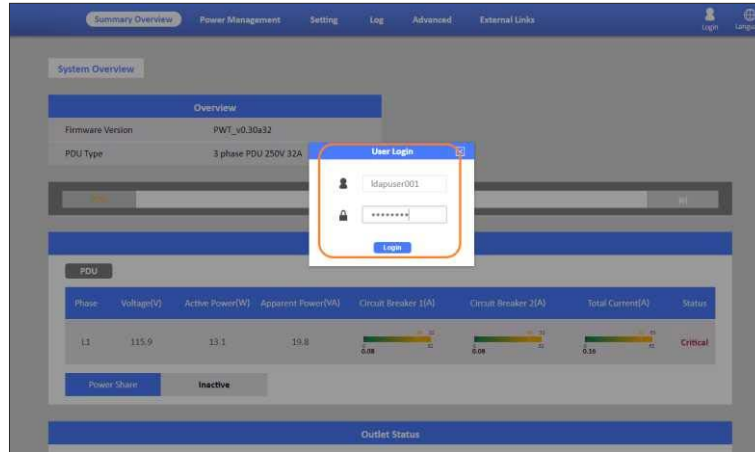

Step 4: To check the login LDAP username on the **Network Connect** of **Summary Overview** webpage as shown screen.

Network Connect		
Source Host Address	Connection Type	Username
172.31.34.222	HTTP	ldapuser001

Step 5: The LDAP user can control the related outlets on the **Outlet Control** of **Power Management** webpage.

The screenshot shows the 'Outlet Control' page with a table of outlets. The table has columns for Outlet ID, Outlet Name, Current, Power (W/VA) Active/Apparent, Full power monitor, Action, State, and Status. Several rows are highlighted with orange circles, showing outlets 01, 04, and 07. The 'State' column for these outlets is 'OFF', and the 'Action' column has a 'Detail' button and a 'No Action' dropdown.

Outlet ID	Outlet Name	Current	Power (W/VA) Active/Apparent	Full power monitor	Action	State	Status
1	outlet 01	0.00	0.0/0.0	Detail	No Action	OFF	Normal
2	outlet 02	0.00	0.0/0.0	Detail	No Action	ON	Normal
3	outlet 03	0.00	0.0/0.0	Detail	No Action	OFF	Normal
4	outlet 04	0.00	0.0/0.0	Detail	No Action	OFF	Normal
5	outlet 05	0.00	0.0/0.0	Detail	No Action	ON	Normal
6	outlet 06	0.00	0.0/0.0	Detail	No Action	ON	Normal
7	outlet 07	0.00	0.0/0.0	Detail	No Action	OFF	Normal
8	outlet 08	0.00	0.0/0.0	Detail	No Action	OFF	Normal

Using the Web Interface

The section provides information about setting up the TACACS+ step by step.

Step 1: To set up the PDU, please configure the related TACACS+ parameters on the **Setting** of **Network Service** webpage as shown screen. For example, to enable TACACS+, enter Host IP and Port Number...etc.



The screenshot shows the 'TACACS+ Setting' configuration page. It includes a checkbox for 'Enabled TACACS+' which is checked. Below this are several input fields: 'Host' (172.31.35.184), 'Port Number' (49), 'Secret Key' (masked with dots), 'Timeout(Sec)' (5), 'Retry Count' (3), and 'Authentication Mode' (ASCII).

Field	Value
Enabled TACACS+	<input checked="" type="checkbox"/>
Host	172.31.35.184
Port Number	49
Secret Key
Timeout(Sec)	5
Retry Count	3
Authentication Mode	ASCII

Step 2: Please press “+” icon to add TACACS+ user then configure the related TACACS+ parameters on the **Setting** of **User Setting** webpage as shown screen. For example, set TACACS+ Username, select Privilege to “Outlet Manager” and select the related outlets.

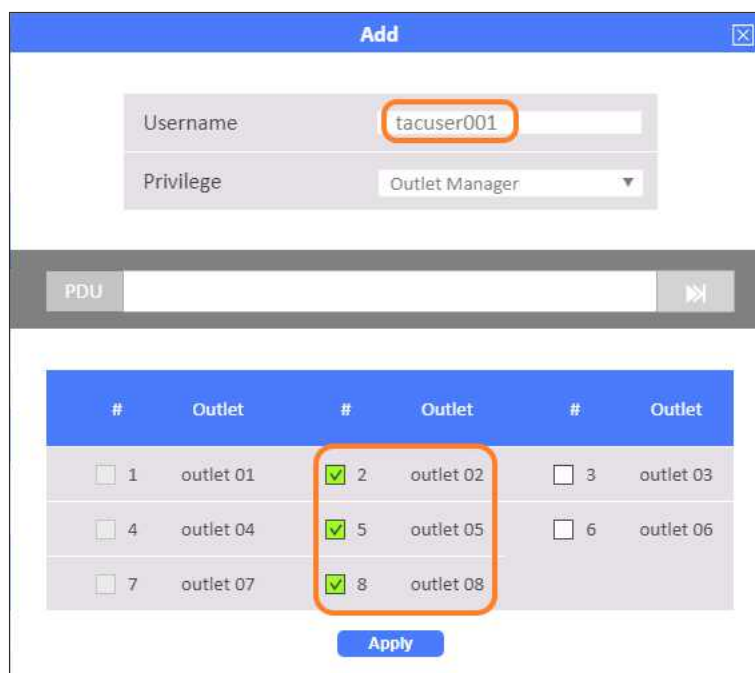

The screenshot shows the 'Add' configuration page for a TACACS+ user. It includes a 'Username' field with the value 'tacuser001' and a 'Privilege' dropdown menu set to 'Outlet Manager'. Below this is a 'PDU' field and a table of outlets. The table has three columns, each with a checkbox and an outlet name. Outlets 2, 5, and 8 are selected with green checkmarks. An 'Apply' button is at the bottom.

#	Outlet	#	Outlet	#	Outlet
<input type="checkbox"/> 1	outlet 01	<input checked="" type="checkbox"/> 2	outlet 02	<input type="checkbox"/> 3	outlet 03
<input type="checkbox"/> 4	outlet 04	<input checked="" type="checkbox"/> 5	outlet 05	<input type="checkbox"/> 6	outlet 06
<input type="checkbox"/> 7	outlet 07	<input checked="" type="checkbox"/> 8	outlet 08		

Using the Web Interface

Step 3: After configured TACACS+ parameter, please logout and close web browser. To enter TACACS+ username and password then login web browser.

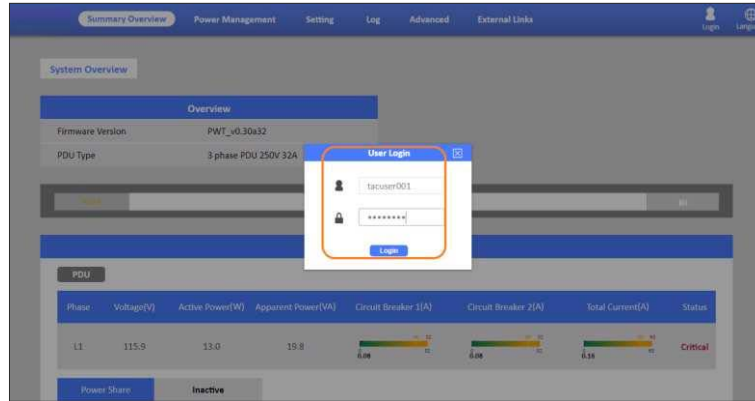

Step 4: To check the login TACACS+ username on the **Network Connect** of **Summary Overview** webpage as shown screen.

Network Connect		
Total TCP Connection : 1		
Source Host Address	Connection Type	Username
172.31.34.222	HTTP	tacuser001

Step 5: The TACACS+ user can control the related outlets on the **Outlet Control** of **Power Management** webpage.

The screenshot shows the 'Outlet Control' page with a table of outlets. The table has columns for Outlet ID, Outlet Name, Current, Power (W/VA) Active/Apparent, Full power monitor, Action, State, and Status. Outlets 2, 5, and 8 are circled in orange. The 'Action' column for these outlets shows 'Detail' buttons and 'No Action' dropdown menus.

Outlet ID	Outlet Name	Current	Power (W/VA) Active/Apparent	Full power monitor	Action	State	Status
1	outlet 01	0.00	0.0/0.0	Detail	No Action	ON	Normal
2	outlet 02	0.00	0.0/0.0	Detail	No Action	ON	Normal
3	outlet 03	0.00	0.0/0.0	Detail	No Action	OFF	Normal
4	outlet 04	0.00	0.0/0.0	Detail	No Action	ON	Normal
5	outlet 05	0.00	0.0/0.0	Detail	No Action	ON	Normal
6	outlet 06	0.00	0.0/0.0	Detail	No Action	ON	Normal
7	outlet 07	0.00	0.0/0.0	Detail	No Action	ON	Normal
8	outlet 08	0.00	0.0/0.0	Detail	No Action	OFF	Normal

Using the Web Interface

Setting - Radius User

This page lets power admin to Add/Delete/Modify Radius users.

You have to Enable RADIUS and set ready in the Network Service. Then you can add a Radius User and set outlet control for this user. The Grouping & Schedule function also supports radius users.



The screenshot shows the 'RADIUS Setting' configuration page. It includes a checkbox for 'Enabled RADIUS', a text field for 'Server IP Address', a text field for 'Secret Key', a text field for 'Port Number' with the value '1812', a text field for 'Timeout Interval' with the value '1' and the unit 'Seconds', and a text field for 'Retry Times' with the value '3'.

NOTE: If there are 2 users with the same name both existed in Local User & Radius User, Local user will become a priority in SCHNEIKEL PDU.

Setting–SNMP Setting

This page shows you all possible SNMP settings.

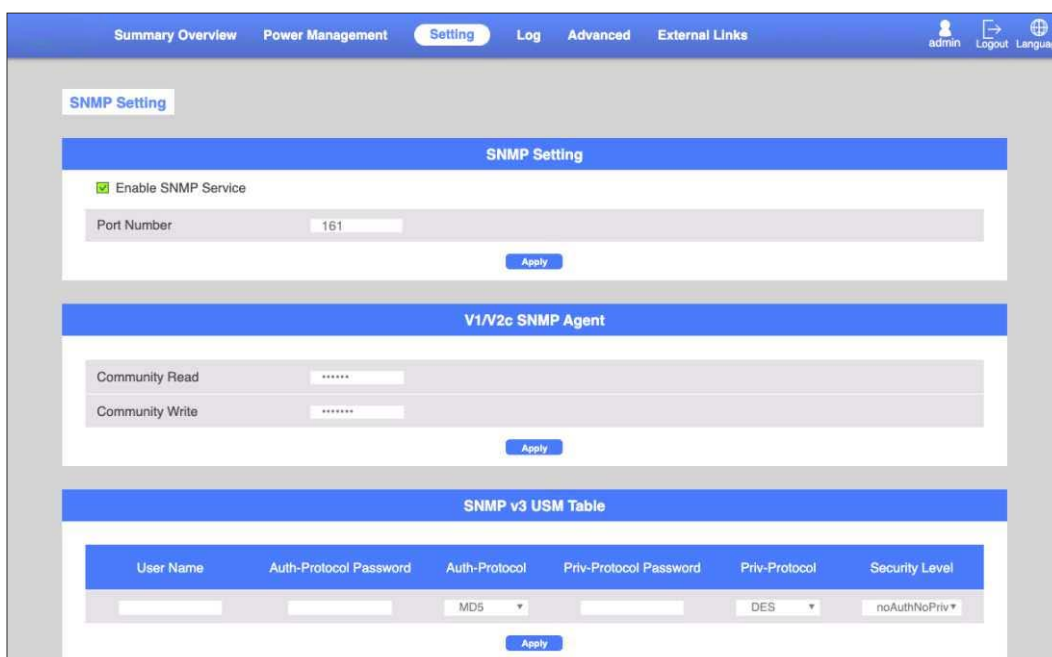

The screenshot shows the 'SNMP Setting' configuration page. It includes a checkbox for 'Enable SNMP Service', a text field for 'Port Number' with the value '161', and an 'Apply' button. Below this is the 'V1/V2c SNMP Agent' section with text fields for 'Community Read' and 'Community Write', and an 'Apply' button. At the bottom is the 'SNMP v3 USM Table' section with a table for configuring users.

User Name	Auth-Protocol Password	Auth-Protocol	Priv-Protocol Password	Priv-Protocol	Security Level
		MD5		DES	noAuthNoPriv

Using the Web Interface

Setting – Email Settings

This page lets the user set Email notification settings. Click "+" to set a new setting. Input "Receiver Address", select "Email Type"/"Event Level" and "Description", then click "Apply" to save settings. You can send a test mail to confirm the setting is correct or not through clicking "Send Test". After setting well, you will get a notification email when the event has been triggered.

The screenshot displays the 'Email Settings' configuration page. At the top, there is a navigation bar with 'Setting' selected. Below the navigation bar, the 'Email Settings' section is visible. It contains two main panels: 'Configure SMTP Server' and 'Email Notification Setting'. The 'Configure SMTP Server' panel includes fields for SMTP Server, Port Number (set to 25), Sender Email Address, Prefix, a checkbox for 'Enable SMTP Authentication', UserName, and Password. An 'Apply' button is located below these fields. The 'Email Notification Setting' panel features a table with columns for Index, Receiver Address, Email Type, Event Level, and Description. The table is currently empty.

Setting – User Settings

This page shows the user list and admin that can add/delete/modify it. The list can be upto 8 users. There are 4 kinds of privileges for the user account, the definition is as below:

Privilege	Definion
Power Admin	Users can manage all funcons.
Admin	Admin users cannot manage [User Management], [Outlet Grouping], [FW Upgrade & Inlet/Outlet Upgrade], [Reset Default] funcon,` and the others can sll manag e.
Supervision	Supervision users only manage [Power Monitoring] beside [Outlet Grouping], [Inlet/outlet upgrade] funcon.
User	Cannot manage any funcon. R ead only.

Also you can add or delete users under Radius, LDAP, TACACS+ and create new passwords for each user

Using the Web Interface

Log and Notification-System Log

This page shows the system log.

Date&Time	Event Description
14/04/2023 14:45:54	Local User Outlet Setting had changed via HTTP/HTTPS by 192.168.124.40
14/04/2023 14:45:54	Local User Outlet Setting had changed via HTTP/HTTPS by 192.168.124.40
14/04/2023 14:45:54	Local User Outlet Setting had changed via HTTP/HTTPS by 192.168.124.40

Log and Notification-Event Log

This page shows the warnings and alarms history log.

Date&Time	Event Level	Event Description
14/04/2023 14:52:59	Information	Inlet (R&M:1) phase3 voltage was higher than warning set point
14/04/2023 14:52:58	Information	Inlet (R&M:1) phase3 voltage had returned from warning to normal

Log and Notification-Inlet History Log

This page shows the inlet history log. You can set the log interval in General Setting under the System Management. You can download the logs in .csv file or graphics.

Date&Time	Device Name	Pwr.W	Pwr.Max.W	Ph1 I.A	Ph2 I.A	Ph3 I.A	Ph1 I Max.A	Ph2 I Max.A	Ph3 I Max.A	Ent
14/04/2023 14:56:09	R&M	0	0	0	0	0	0	0	0	
14/04/2023 14:55:07	R&M	0	0	0	0	0	0	0	0	

Using the Web Interface

Log and Notification-Outlet History Log

This page shows the inlet history log. You can set the log interval in General Setting under the System Management. You can download the logs in .csv file or graphics.

Date&Time	Device Name	Outlet Name	Pwr.W	Pwr Max.W	Energy.kWh	I.A	PF	Fre.Hz
14/04/2023 14:57:11	R&M	outlet 01	0	0	0	0	1	49.9
14/04/2023 14:57:11	R&M	outlet 02	0	0	0	0	1	49.9

Log and Notification-Environment History Log

This page shows the environment history log. You can set the log interval in General Setting under System Management. You can download the logs in .csv file or graphics.

Date&Time	Device Name	EMD Name	Temp.C	Hum.%RH
14/04/2023 14:58:13	R&M	EMD1	24.3	65.6
14/04/2023 14:57:11	R&M	EMD1	24.3	65.6
14/04/2023 14:56:09	R&M	EMD1	24.3	65.7
14/04/2023 14:55:07	R&M	EMD1	24.3	65.7

Using the Web Interface

ADVANCED – SYSLOG Setting

You can receive system and History logs to your server enabling them and indicating the server port.

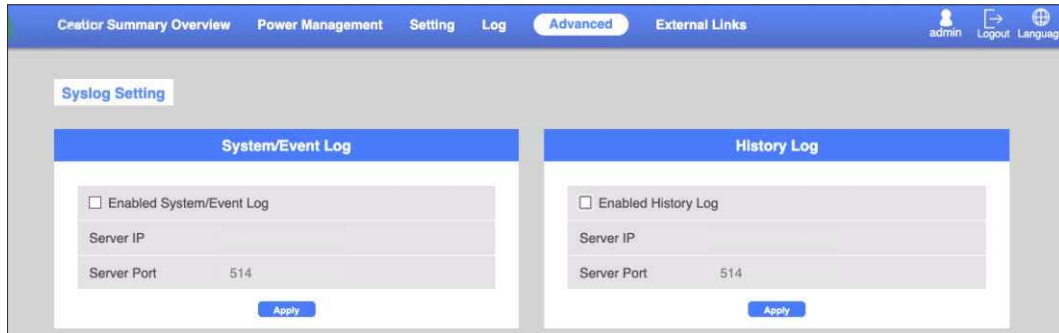

ADVANCED – Maintenance

Keep the PDU up to date installing always latest firmware versions available on the website, reset to default or reboot the system in case of not proper function. You can also suspend all the schedules just enabling on the web page.

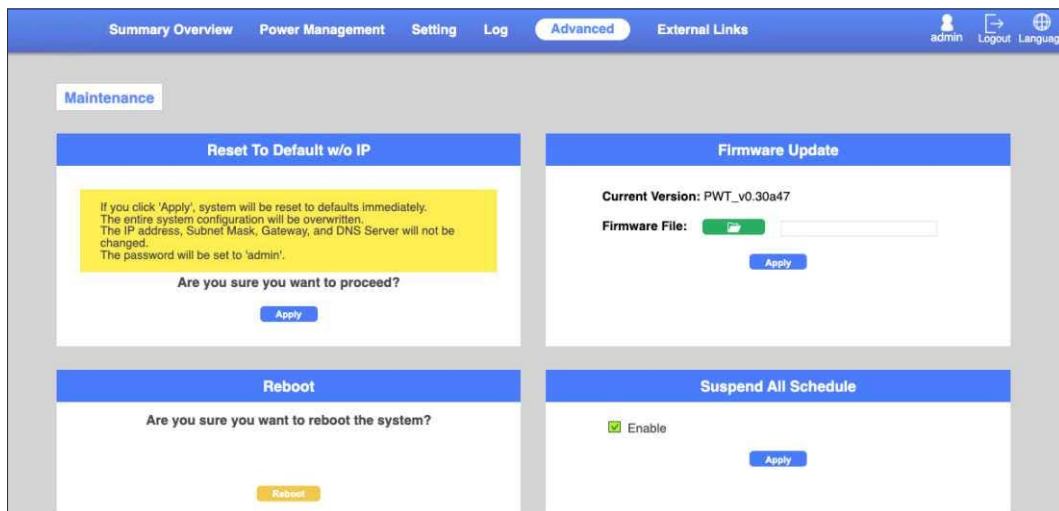

ADVANCED – Import / Export

Easy copy PDU configuration with the export and import files in JSON format.

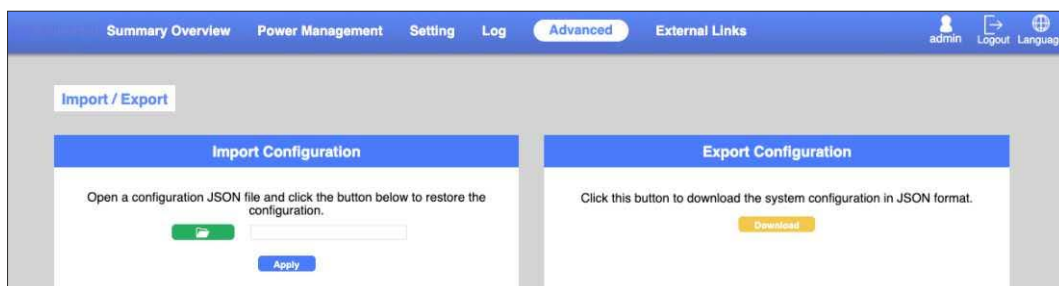

Using the Web Interface

ADVANCED – Links Setting

Use External Links Setup to view and change up to 4 URL links displayed in External Links.

Screen Text: This field defines the URL name displayed in External Links. The maximum size is 31 characters. Available values are alphabetic characters note 1 and numerals. The default value is NULL (empty).

Link Address: This field defines the URL address for external link. The maximum size is 63 characters. Available values are alphabetic characters note 1, symbols and numerals. The default value is NULL (empty).

Status: This field decides whether the external link is available. Available values are "Hide" and "Show". The default value is "Hide" and Screen Text does not display in External Links.

The screenshot shows the 'Links Setting' page in a web interface. At the top, there is a navigation bar with tabs: Summary Overview, Power Management, Setting, Log, Advanced (selected), and External Links. On the right, there are user options: admin, Logout, and Language. Below the navigation, there is a 'Links Setting' tab. The main content area is titled 'External Link' and contains a table with the following structure:

Index	Screen Text	Link Address	Status
1	<input type="text"/>	<input type="text"/>	hide ▼
2	<input type="text"/>	<input type="text"/>	hide ▼
3	<input type="text"/>	<input type="text"/>	hide ▼
4	<input type="text"/>	<input type="text"/>	hide ▼

At the bottom of the table, there is an 'Apply' button.

Using the Web Interface

Dual Ethernet Mode

SCHNEIKEL GIGA PDU allows system administrators to set up bonding interfaces with different modes. A bonding mode specifies the policy indicating how bonding slaves are used during network transmission. To achieve the maximum throughput and fault toleration, it is important to choose the proper bonding mode and the corresponding options for the setup.

The current version of the bonding module supports the following bonding modes:

Mode 1 (Active Backup):

Active Backup policy establishes that only one slave in the bond is active. A different slave becomes active if, and only if, the active slave fails.

The bond's MAC address is externally visible on only one port (network adapter) to avoid confusing the switch. This mode provides fault tolerance.

The primary option affects the behavior of this mode.

- Use the browser to go to the GIGA PDU address and check the page for the “**Dual Ethernet**” in the “**Advance**” menu list.
- Please select “**Active Backup**” model and verify the related action as flow screen.

Dual Ethernet		
Dual Ethernet Mode	Active Backup	▼
MII Monitoring	100	milliseconds(Range 1 - 65535)
Down Delay	0	milliseconds(Range 0 - 65535)
Up Delay	0	milliseconds(Range 0 - 65535)
Primary Ethernet	eth1	▼
Apply		

Using the Web Interface

Mode 2 (IEEE 802.3ad):

Bonding mode 2 (IEEE 802.3ad), also known as LACP (Link Aggregation Control Protocol) mode, is used for load balancing and fault tolerance. The IEEE 802.3ad specification allows the grouping of Ethernet interfaces at the physical layer to form a single link layer interface. If a bonding interface is set to this mode, it requires that all the slave devices operate at the same speed and are duplex. In this way, the network can benefit from the aggregated bandwidth of all the slaves, and if one of the slaves is down, the whole network will not be affected.

Notes: The switch should be configured to support the mode 802.3ad standard and use the LACP protocol. The 802.3ad mode only works with MII link monitor.

- Use the browser to go to the GIGA PDU address and check the page for the “**Dual Ethernet**” in the “**Advance**” menu list.
- Please select “**IEEE 802.3ad**” model and verify the related acon` as flow screen.

Dual Ethernet		
Dual Ethernet Mode	<input type="text" value="IEEE 802.3ad"/>	
MII Monitoring	<input type="text" value="100"/>	milliseconds(Range 1 - 65535)
Down Delay	<input type="text" value="0"/>	milliseconds(Range 0 - 65535)
Up Delay	<input type="text" value="0"/>	milliseconds(Range 0 - 65535)
Primary Ethernet	<input type="text" value="eth1"/>	
<input type="button" value="Apply"/>		

Using the Web Interface

Mode 3 (Balance-ALB):

Adaptive load balancing. Includes balance-transmit load balancing plus receive-load balancing for IPv4 traffic, and does not require any special switch support. The receive-load balancing is achieved by ARP negotiation.

The bonding driver intercepts the ARP replies sent by the local system on their way out and overwrites the source hardware address with the unique hardware address of one of the slaves in the bond. Thus, different peers use different hardware addresses for the server.

- Use the browser to go to the GIGA PDU address and check the page for the “**Dual Ethernet**” in the “**Advance**” menu list.
- Please select “**Balance ALB**” model and verify the related acon` as flow screen.



The screenshot shows a web interface for configuring Dual Ethernet. The title bar is blue and contains the text "Dual Ethernet". Below the title bar, there are five rows of configuration options, each with a label, a value field, and a unit/range description. The "Dual Ethernet Mode" is set to "Balance ALB" in a dropdown menu. "MII Monitoring" is set to "100" milliseconds (Range 1 - 65535). "Down Delay" is set to "0" milliseconds (Range 0 - 65535). "Up Delay" is set to "0" milliseconds (Range 0 - 65535). "Primary Ethernet" is set to "eth1" in a dropdown menu. At the bottom right of the form is a blue "Apply" button.

Dual Ethernet		
Dual Ethernet Mode	Balance ALB	
MII Monitoring	100	milliseconds(Range 1 - 65535)
Down Delay	0	milliseconds(Range 0 - 65535)
Up Delay	0	milliseconds(Range 0 - 65535)
Primary Ethernet	eth1	

Apply

Using the Web Interface

Mode 4 (Bridge):

Bridging the two networks together can be quite helpful, though, if files located on one of the networks need to be accessed from the other network. If you don't have a router but have a PC with two Ethernet cards, you can connect both networks to the PC and bridge your Ethernet cards so both networks can communicate with each other.

- Use the browser to go to the GIGA PDU address and check the page for the “**Dual Ethernet**” in the “**Advance**” menu list.
- Please select “**Bridge**” model and verify the related configuration flow screen.



The screenshot shows the 'Dual Ethernet' configuration page. It features a blue header with the title 'Dual Ethernet'. Below the header, there are several configuration fields:

- Dual Ethernet Mode:** A dropdown menu currently set to 'Balance ALB'.
- MII Monitoring:** A text input field containing '100', with a unit of 'milliseconds(Range 1 - 65535)'.
- Down Delay:** A text input field containing '0', with a unit of 'milliseconds(Range 0 - 65535)'.
- Up Delay:** A text input field containing '0', with a unit of 'milliseconds(Range 0 - 65535)'.
- Primary Ethernet:** A dropdown menu currently set to 'eth1'.

An 'Apply' button is located at the bottom right of the configuration area.

- Connect one Ethernet port to DHCP server and another to PC Ethernet port as shown below.
- After connecting , check PC system to get DHCP IP.

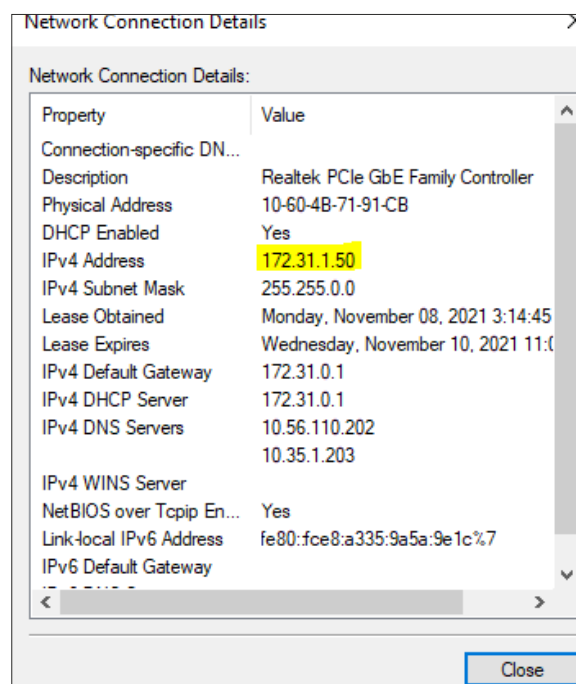

Using the Web Interface

ADVANCED – Wifi or 3G/4G dongle setting

Step 1: To set up the PDU, plug the Wi-Fi or 3G/4G dongle into USB-A (1 or 2) port.

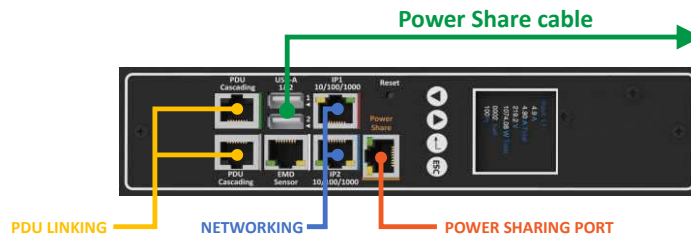

Step 2: To configure the related Wi-Fi or 3G/4G parameters on the **Wi-Fi setting** of **Advanced** webpage as shown screen. For example, to enable Wi-Fi Control, enter Wi-Fi SSI: TOTOLINK_A1004... etc

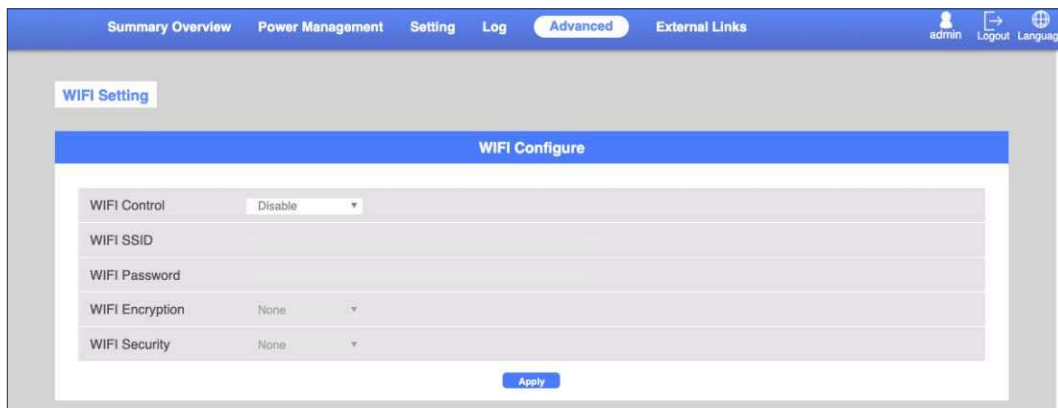

Step 3: After configured Wi-Fi parameters, the related Wi-Fi status is automatically displayed on the **Wi-Fi or 3G/4G Status**. For example, to enable Wi-Fi Control, enter Wi-Fi SSI: TOTOLINK_A1004... etc as shown screen.



Step 4: Please access the dongle IP address and make sure the Wi-Fi or 3G/4G dongle is workable.

Using the Web Interface

ADVANCED – Inlet & Outlet upgrade

Time to time we release improvements on the internal hardware related to metering chip upgrades or calibration, just upload the file as shown on the screen.

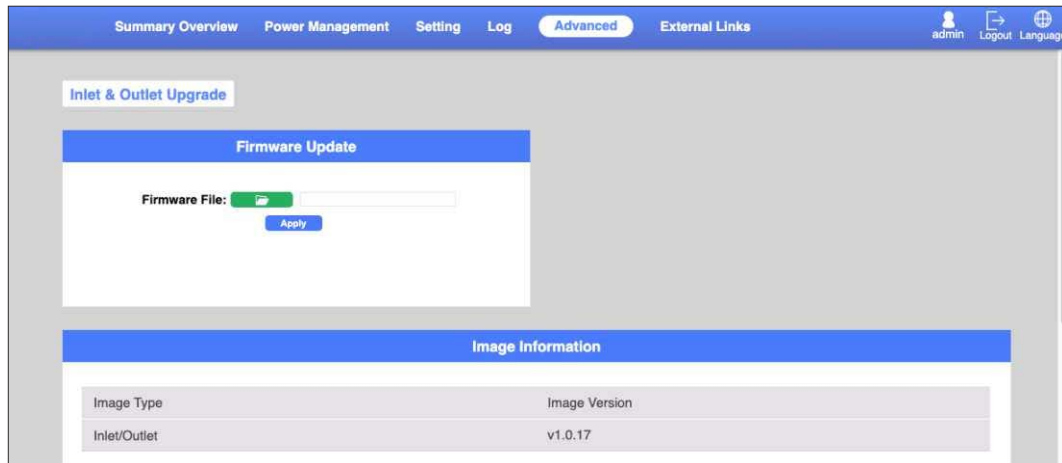

ADVANCED – EMD31 upgrade

Time to time we release improvements on the environmental chip calibration, just upload the file as shown on the screen.

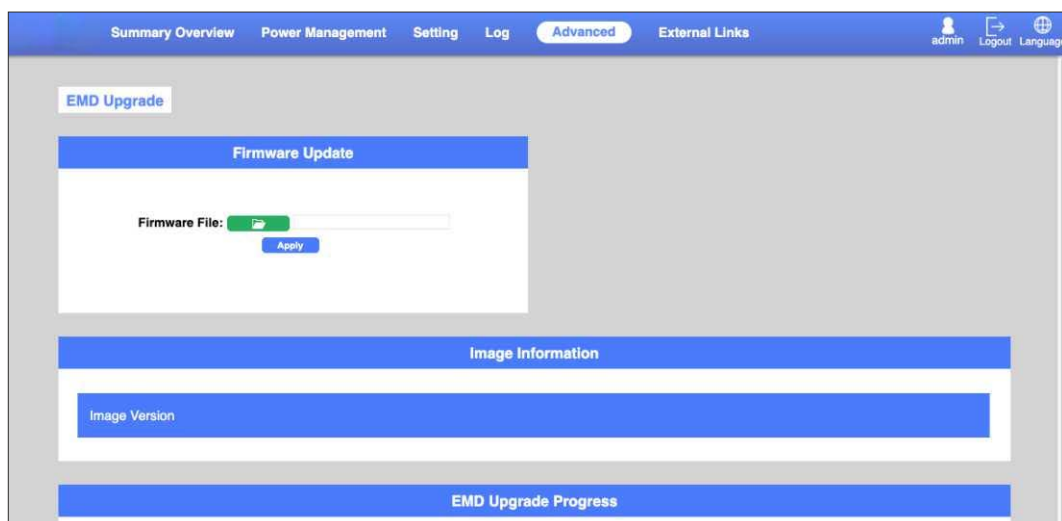



schneikel

the 19" company

Schneikel Electronics GmbH | Steinhaldenstrasse 24 | CH-8954 Geroldswil
Tel +41 44 404 10 10 | info@schneikel.ch | www.schneikel.ch