



«Schneikel-Line»

Access 19" Schränke

Netzwerkschränke

Serverschränke

Cold / Hot Aisle

Kühlung

Wandschränke

Zubehör



Access Cabinet System

Contents

Section	Page
Introduction	1
Flexibility On Demand	2
The Cabinet	3
Access – Design Features	4-5
Dynamic Part Coding	6
Access Part Code Matrix	7
Flexibility By Design	8-9
Network Cabinet	10-11
Active Cabinet	12-13
Advanced Managed Distribution Frame	14-15
Co-Locate / Multi Hosting Cabinet	16-17
3 into 2 Cabinet	18-19
High Density Copper Cabling Cabinet	20-21
High Density Fibre Cabling Cabinet	22-23
High Density Server Cabinet	24-29
Cold Aisle Containment	30-33
Hot Aisle Containment	34-37
Configure Your Own Cabinet	38-39
Step 1 - Frame Configuration	40-42
Step 2 - Door Configuration	43-44
Step 3 - Side Panel Configuration	45
Step 4 - Top Panel Configuration	46
Step 5 - Colour	47
Step 6 - Packaging Options	48
Specifying & Ordering Component Assemblies	49
Configuring a Cabinet For Thermal Loads	50-53
Component Assembly Specification & Order Codes Frame Only Assemblies	54-55
Component Assembly Specification & Order Codes Mounting Angle Only Options	56-57
Component Assembly Specification & Order Codes Base Mounting Options	58-59
Component Assembly Specification & Order Codes Base Blanking Options	60-61
Component Assembly Specification & Order Codes Top Panel Options	62-63
Component Assembly Specification & Order Codes Side Panel Options	64
Component Assembly Specification & Order Codes Door Options	65-71
Shelf Options	72-73
Universal Fixed Adjustable Depth Shelves	74
Shelf Mounting Matrix	75
Vertical Cable Management Options	76-79
Horizontal Cable Management	80-81
Cable Hoops & Arms	82
19-Inch Blanking Panels	83
Front to Rear Blanking Panels	84
Front to Rear Cable Troughs	85
600mm Wide Cabinet Vertical Baffles	86
800mm Wide Cabinet Vertical Baffles	87

Contents

Section	Page
Scavenger Fan Units	88-89
Rack Mounted Fan Units	89
Earth Kits & Earth Bars	90
Unit Height Labels	91
Standard PDUs	92-95
Stand Alone Intelligent PDUs	96-97
i-Pal & i-Box System	98
i-Box Solution	99-101
i-Box Sensor Options	102-106
i-Box Compatible PDUs	107-108
i-Box Shelving	109
i-REM Intelligent Rack Extinguisher Module	110-112
Cabinet Lighting	113
Ancillary Accessories	114
Access Cabinet Technical Specification	115-118
CFD Analysis	119
Access Configurator	120
How To Software	121
Technical Capabilities	122-123
Access Custom Capabilities	124
Customer Support	125
Notes	126

The Cabinet

■ Focus

The cabinet has in the past been considered to be “just a metal box” providing the mounting structure into which the interesting expensive equipment was mounted. Nowadays however, the cabinet is performing an increasingly important role, not only having to house a number of different technologies but also providing a framework to allow individual installations to be tailored to best match the constraints and demands encountered.

The form and function of the cabinet structure can complement the operational efficiency of an installation given some consideration and forethought. Equally, failure to understand and address potential issues, can lead to increased operational costs as well as the threat of premature system failure.

Cooper B-Line's Access Cabinet System, the original corner-less cabinet, has been developed and enhanced with the goal of providing the ultimate cabinet solution. Designed from the frame up, the Access Cabinet System has evolved with application excellence and user friendliness in mind.

Each Access Cabinet solution is based on the same cantilever frame concept using a tubular frame top and bottom connected by central extrusions. This design allows unhindered 180° degree clearance around the front and rear mounting angles whilst at the same time offering clear access to the internal cabinet envelope.

This crucially allows installation and maintenance to be carried out in a far more efficient manner and ultimately provides the tool to reduce the total cost of ownership during the lifetime of the cabinet. The wide range of cabinet sizes offered provides the ability to construct a diverse range of internal configurations, allowing both existing and next generation network components to be housed, irrespective of their mounting requirements.

■ Unique

So what makes Access so different from conventional cabinets? The unique construction, open architecture without corner posts, enables the quick removal of all panels/doors to completely expose the open frame for installation of cables and/or equipment. Far neater, faster and user friendly cable installations are possible compared with conventional cabinets. The resultant installation is much easier to maintain with ready access to equipment and the avoidance of messy, un-workable cabling arrangements.

■ Effective

The Access cabinet open frame structure provides virtually 360° total accessibility, prior to fitting panels and doors, which gives installers maximum working access and the opportunity to greatly improve installation times. The elimination of corner posts also removes the need to excessively inset 19-inch mounting angles, achieving maximum equipment and working space.

■ Flexible

The number of cabinet combinations available further enhances the strength of the Access design. From door options to top panels, Access achieves an unparalleled level of flexibility, providing the end user with the right cabinet for the right application.



Access – Design Features

Open frame structure providing optimal access configurability

Configurable top panel options

- Range of plain, vented, cable entry,
- Configurable into any order

Door Configurations

- Quick release hinging
- Configurable left or right hinged
- Secure
- Single and double door options

Half depth hinged side panels

- Easier handling
- Quick release latching
- Secure
- Earth bonding facility

Range of base blanking and cabinet mounting options

Colour options

- Hardware and mouldings in Blue, Black options available on request
- Panels available in Light Grey and Black options available on request

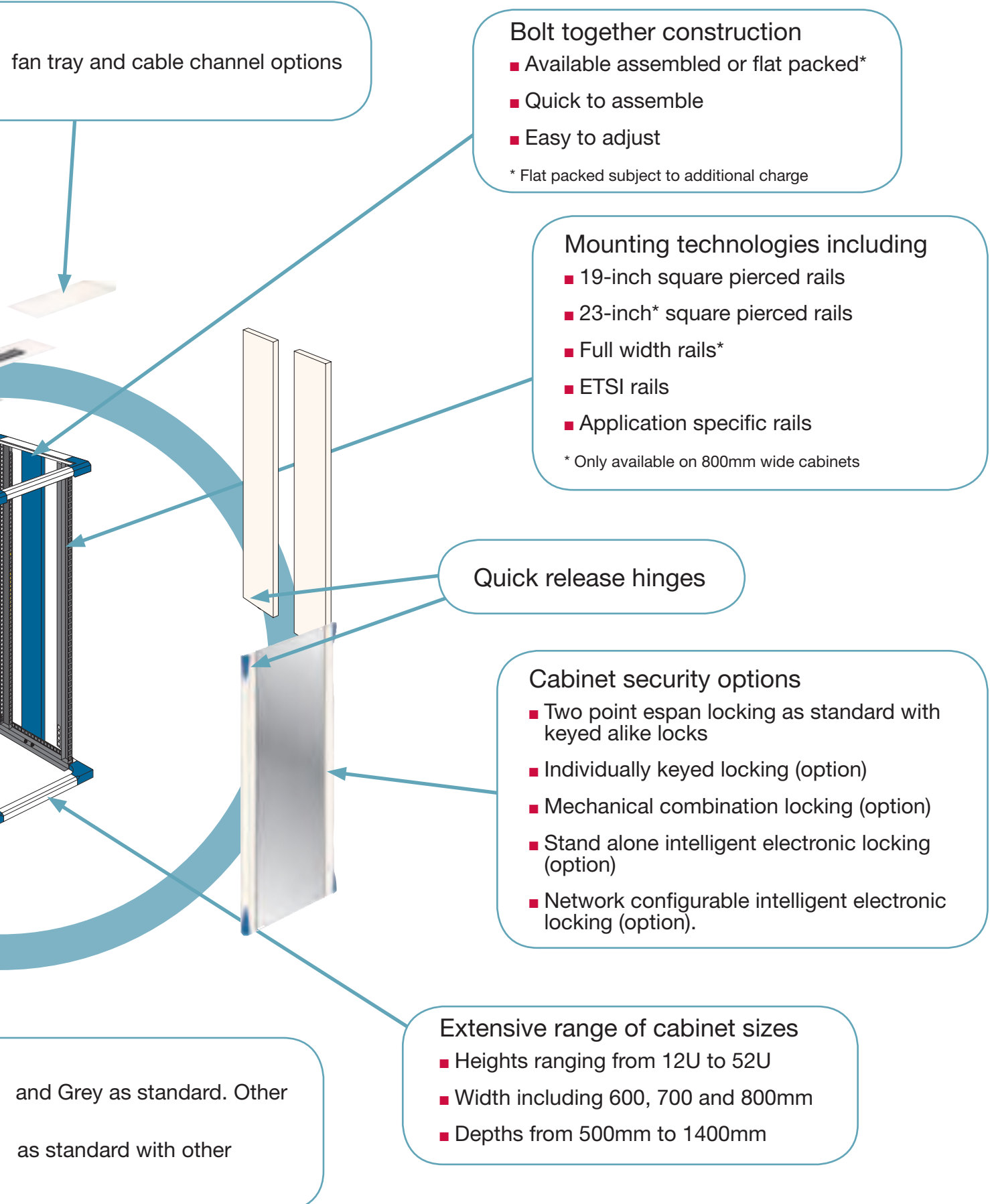

fan tray and cable channel options

Bolt together construction

- Available assembled or flat packed*
- Quick to assemble
- Easy to adjust

* Flat packed subject to additional charge

Mounting technologies including

- 19-inch square pierced rails
- 23-inch* square pierced rails
- Full width rails*
- ETSI rails
- Application specific rails

* Only available on 800mm wide cabinets

Quick release hinges

Cabinet security options

- Two point espan locking as standard with keyed alike locks
- Individually keyed locking (option)
- Mechanical combination locking (option)
- Stand alone intelligent electronic locking (option)
- Network configurable intelligent electronic locking (option).

Extensive range of cabinet sizes

- Heights ranging from 12U to 52U
- Width including 600, 700 and 800mm
- Depths from 500mm to 1400mm

and Grey as standard. Other as standard with other

Dynamic Part Coding

Part Number

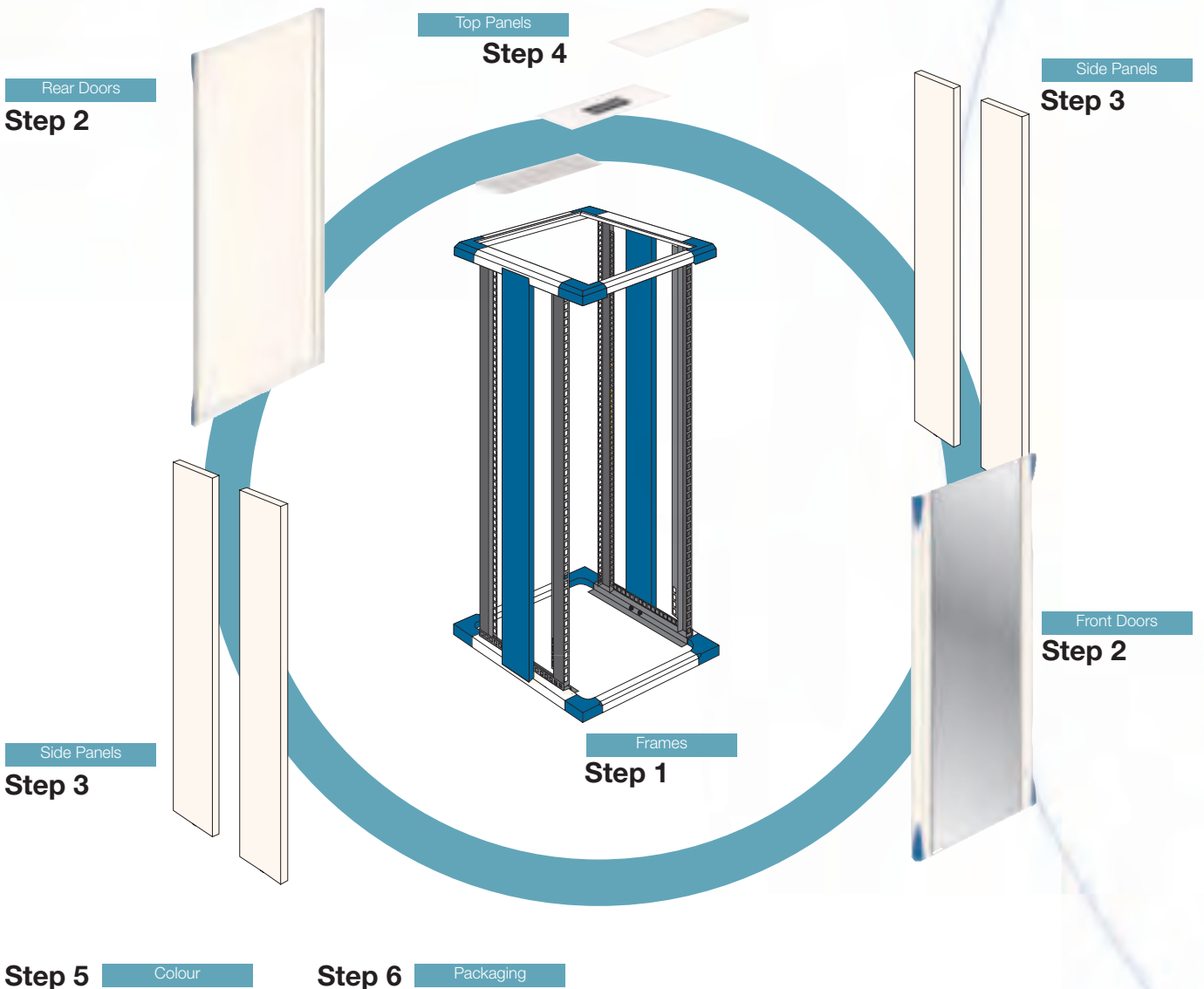
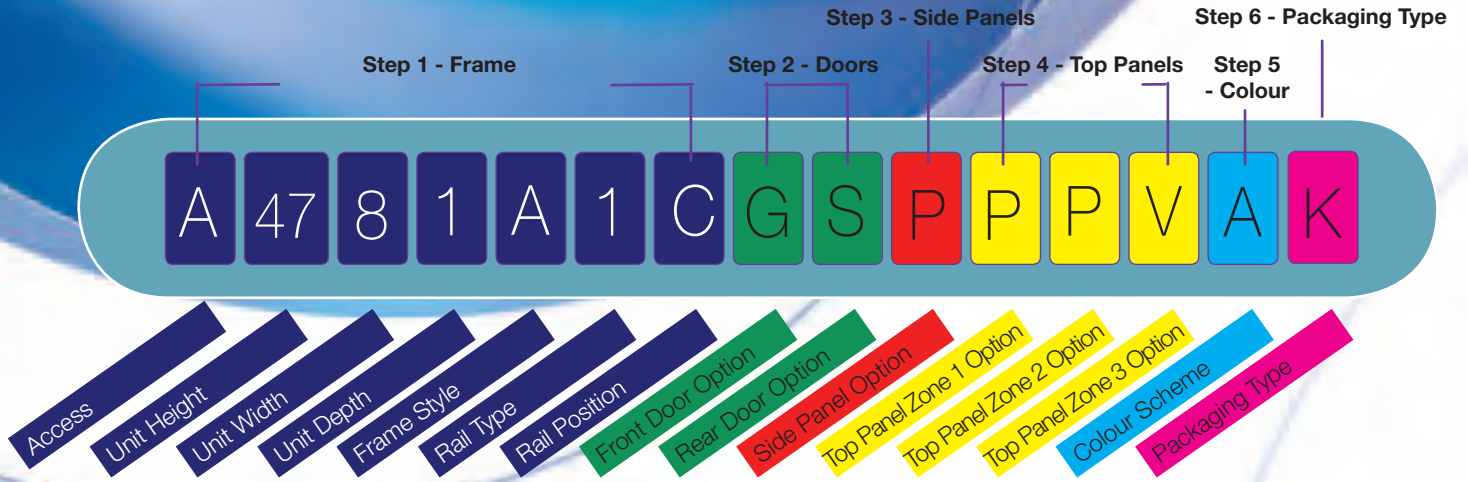

Access Part Code Matrix

A	Access	
47	Unit Height	Stock Sizes - 22U, 27U, 39U, 42U, 47U Non Stocked Sizes - 12U, 17U, 32U, 45U, 52U Custom Sizes Available Upon Request
8	Unit Width	6 = 600mm 7* = 700mm 8 = 800mm
1	Unit Depth	6 = 675mm 8 = 875mm 9 = 915mm 1 = 1000mm 2 = 1200mm 4* = 1400mm
A	Frame Style	A = Standard Corner Plates + Jacking Feet C = Frame On Nylon Skids G = Standard Corner Plates + Castors H = Universal Corner Plates + Jacking Feet + Castors P = With Standard Plinth Kit + Jacking Feet Q = With Standard Plinth Kit + Jacking Feet + Castors L = With Stabilising Plinth + Jacking Feet M = With Stabilising Plinth + Jacking Feet + Castors O = Standard Plinth + Castors U = Universal Corner Plates + Jacking Feet S = Standard Corner Plates + Short Skids
1	Rail Type	1 = 19-inch (x4) 2 = 23-inch (x4) 5 = Full Width (x4) 6 = 19-inch (x2) 7 = ETSI (x4) 8 = 19-Inch with RCM+ Fingers (x4)
C	Rail Position	L = Offset Left R = Offset Right C = Centre
G	Front Door Option	A = Acrylic Glazed Door – LH Hinged B = Acrylic Glazed Door – RH Hinged C = Access Cover Trims G = Glazed Door (Vented Styles) – LH Hinged H = Glazed Door (Vented Styles) – RH Hinged I = High Flow Server Door With Metal Trims – LH Hinged J = High Flow Server Door With Metal Trims – RH Hinged L = Wardrobe Style Double Glazed Doors – LH Hinged N = No Doors O = Glazed Door (Non Vented Styles) – LH Hinged P = Glazed Door (Non Vented Styles) – RH Hinged Q = Pressurised Rear Door – LH Hinged R = Pressurised Rear Door – RH Hinged S = Plain Steel Door – LH Hinged T = Plain Steel Door – RH Hinged V = Vented Steel Door – LH Hinged W = Vented Steel Door – RH Hinged Y = Wardrobe Style Double Plain Steel Doors Z = Wardrobe Style Double Vented Steel Doors
S	Rear Door Option	
P	Side Panel Option	P = Plain Both Sides L = Plain Left Side Only R = Plain Right Side Only E* = Vented Left Side Only F* = Vented Right Side Only V* = Vented Both Sides N = No Panels Both Sides
P	Top Panel Zone 1 Option	B = Brush Strip C = Brush Strip Infill E = Vented Brush Strip N = No Panel P = Plain V = Vented X = Plain Infill
P	Top Panel Zone 2 Option	2 = 2-Way Fan Tray (110v A/C) 3 = 3-Way Fan Tray (110v A/C) 4 = 2-Way Fan Tray (230v A/C) 5 = 2-Way Fan Tray + Controller 6 = 3-Way Fan Tray (230v A/C)
V	Top Panel Zone 3 Option	
A	Colour Scheme	A = Light Grey + Blue Trim B = Black + Black Trim C = Light Grey + Black Trim D = Black + Blue Trim G = Light Grey + Mid Grey Trim
K	Packaging Type	No Character = Assembled and Palletised B = Cabinet Components Bulk Packed For Local Assembly K = Each Cabinet Individually Flat Packed

Items marked * are either held as limited stock or made to order. Please contact our customer services team for availability.

Flexibility By Design

Network Cabinet
page 10



Active Cabinet
page 12



Hot & Cold Aisle Containment
page 30 & 34



High Density Server Cabinet
page 24



High Density Fibre Cabling Cabinet
page 22

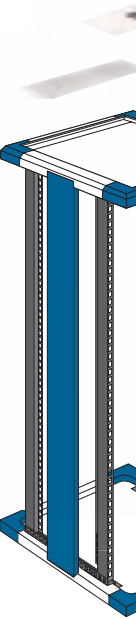

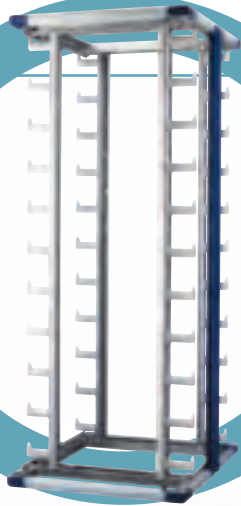

AMDF Cabinet
page 14



Co-Locate Cabinet
page 16

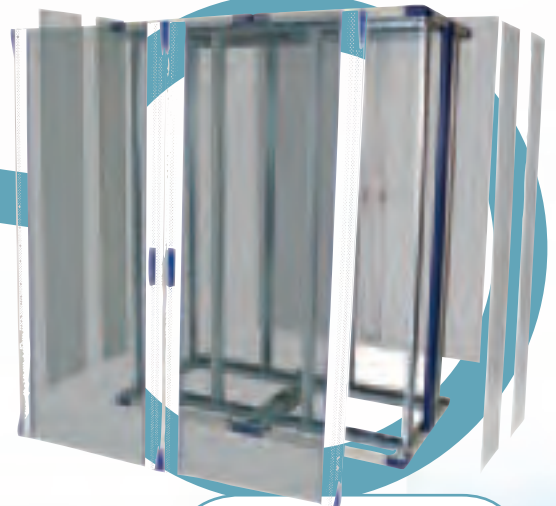

3 into 2 Cabinet
page 18



High Density Copper
Cabling Cabinet
page 20

Network Cabinet

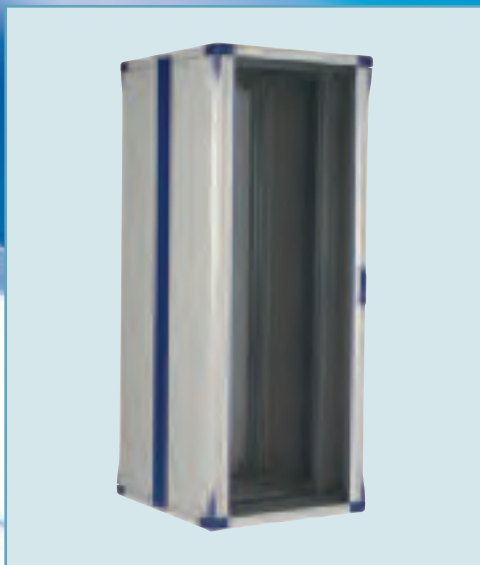

Introduction

Most day to day networking installations incorporating low density active equipment or cabling applications, can be accommodated into what has evolved to be the industry standard networking cabinet.

Details of the standard Access Network Enclosure are shown below. In the event of this standard specification not meeting the needs of a specific application then, thanks to Access's modular design, each cabinet can be configured using the simple dynamic part coding shown on pages 6 & 7.

Further details on custom cabinet specification can also be found on page 38

Standard Access Network Enclosure

Each cabinet comprises of the following:

- Access Cabinet base frame mounted on Nylon feet
- Supplied with two pairs of fully adjustable 19-inch mounting angles
- Glazed door with vented styles fitted at the front
- Plain steel door fitted at the rear
- Plain Side Panels fitted both sides
- Top panel configuration comprising of:-
 - 1 x Vented panel fitted at the rear
 - Remaining top panel apertures fitted with plain panels

Height	Width (mm)	Depth (mm)	Order Codes (Assembled)	Order Codes (Flat Packed)
22U	600	675	A2266C1CGSPPNVA	A2266C1CGSPPNVAK
		875	A2268C1CGSPPXVA	A2268C1CGSPPXVAK
		1000	A2261C1CGSPPPVA	A2261C1CGSPPPVAK
27U	600	675	A2766C1CGSPPNVA	A2766C1CGSPPNVAK
		875	A2768C1CGSPPXVA	A2768C1CGSPPXVAK
		1000	A2761C1CGSPPPVA	A2761C1CGSPPPVAK
32U	600	675	A3266C1CGSPPNVA	A3266C1CGSPPNVAK
		875	A3268C1CGSPPXVA	A3268C1CGSPPXVAK
		1000	A3261C1CGSPPPVA	A3261C1CGSPPPVAK
39U	600	675	A3966C1CGSPPNVA	A3966C1CGSPPNVAK
		875	A3968C1CGSPPXVA	A3968C1CGSPPXVAK
		1000	A3961C1CGSPPPVA	A3961C1CGSPPPVAK
42U	600	675	A4266C1CGSPPNVA	A4266C1CGSPPNVAK
		875	A4268C1CGSPPXVA	A4268C1CGSPPXVAK
		1000	A4261C1CGSPPPVA	A4261C1CGSPPPVAK
47U	600	675	A4766C1CGSPPNVA	A4766C1CGSPPNVAK
		875	A4768C1CGSPPXVA	A4768C1CGSPPXVAK
		1000	A4761C1CGSPPPVA	A4761C1CGSPPPVAK

Order codes denote std. light grey and blue finish.

Details are subject to change without written notification.

Option Overview

- Six standard heights. Other heights are available subject to order up to a maximum of 52U.
- Two standard widths of 600mm and 800mm with other options including 700mm wide assemblies subject to order.
- Three standard depth options including 675mm, 875mm and 1000mm. Other depth options are available to order up to a maximum of 1400mm.

Finish Options

Cooper B-Line's Access cabinet is available in a range of standard colour options other than the default standard which is Colour Ref.

- Light Grey with Blue Trim – Colour Ref. A

Other standard colour options include

- Black with Black Trim – Colour Ref. B
- Light Grey with Black Trim – Colour Ref. C
- Black with Blue Trim – Colour Ref. D
- Light Grey with Mid Grey Trim – Colour Ref. G

Custom colour options are also available subject to minimum order quantities and lead times

Accessories

A comprehensive range of accessories are available to suit every application. Details of specific items can be found on the pages indicated below;

■ Cabinet Cladding Enhancements	38
■ Floor Mounting Options	38
■ Base Cable Entry	38
■ Roof Cable Entry	38
■ Vertical Cable Management	76
■ Horizontal Cable Management	80
■ General Cable Management	82
■ Rack Mounted Thermal Management	89
■ Power Distribution	92
■ 19-Inch Blanking Panels	83
■ Shelf Options	72
■ Bolt Together Options	91
■ Earthing Accessories	90
■ Cabinet Light	113
■ Access Control	98
■ Environmental Monitoring	99
■ Cabinet Fire Suppression	110

Height	Width (mm)	Depth (mm)	Order Code (Assembled)	Order Code (Flat Packed)
22U	800	675	A2286C1CGSPPNVA	A2286C1CGSPPNVAK
		875	A2288C1CGSPPXVA	A2288C1CGSPPXVAK
		1000	A2281C1CGSPPPVA	A2281C1CGSPPPVAK
27U	800	675	A2786C1CGSPPNVA	A2786C1CGSPPNVAK
		875	A2788C1CGSPPXVA	A2788C1CGSPPXVAK
		1000	A2781C1CGSPPPVA	A2781C1CGSPPPVAK
32U	800	675	A3286C1CGSPPNVA	A3286C1CGSPPNVAK
		875	A3288C1CGSPPXVA	A3288C1CGSPPXVAK
		1000	A3281C1CGSPPPVA	A3281C1CGSPPPVAK
39U	800	675	A3986C1CGSPPNVA	A3986C1CGSPPNVAK
		875	A3988C1CGSPPXVA	A3988C1CGSPPXVAK
		1000	A3981C1CGSPPPVA	A3981C1CGSPPPVAK
42U	800	675	A4286C1CGSPPNVA	A4286C1CGSPPNVAK
		875	A4288C1CGSPPXVA	A4288C1CGSPPXVAK
		1000	A4281C1CGSPPPVA	A4281C1CGSPPPVAK
47U	800	675	A4786C1CGSPPNVA	A4786C1CGSPPNVAK
		875	A4788C1CGSPPXVA	A4788C1CGSPPXVAK
		1000	A4781C1CGSPPPVA	A4781C1CGSPPPVAK

Order codes denote std. light grey and blue finish.

Active Cabinet



Introduction

Just about any network component that consumes electricity needs to be managed thermally to operate efficiently. Managing these active components within a secure cabinet environment can be challenging given that different components are designed to be cooled in different ways and can vary significantly in size and weight. Probably the only commonality between them is that usually, but not always, they have been designed to be 19-inch mounted.

To help simplify the configuration process Cooper B-Line has developed a range of modular tools to cope with widely differing demands. The core of the solution is a standard Access Active Cabinet configuration which, like every other Access cabinet, can be easily reconfigured to provide an optimised solution (see the dynamic part code matrix on pages 6 & 7).

Basic Active Equipment Enclosure

- Access Cabinet base frame mounted on Nylon feet
- Supplied with two pairs of fully adjustable 19-inch mounting angles.
- Vented steel front door (80% free area ventilation pattern)
- Plain side panels fitted both sides
- Top panel configuration comprising of;
 - 1 x Vented panel fitted at rear.
 - The remaining top panel apertures fitted with plain infill panels.

A full range of modular thermal enhancements are available to optimise the deployment of installations housing both conventional server applications as well as mixed technology configurations. For further details of the range of modular thermal enhancements please refer to pages 50 to 53.

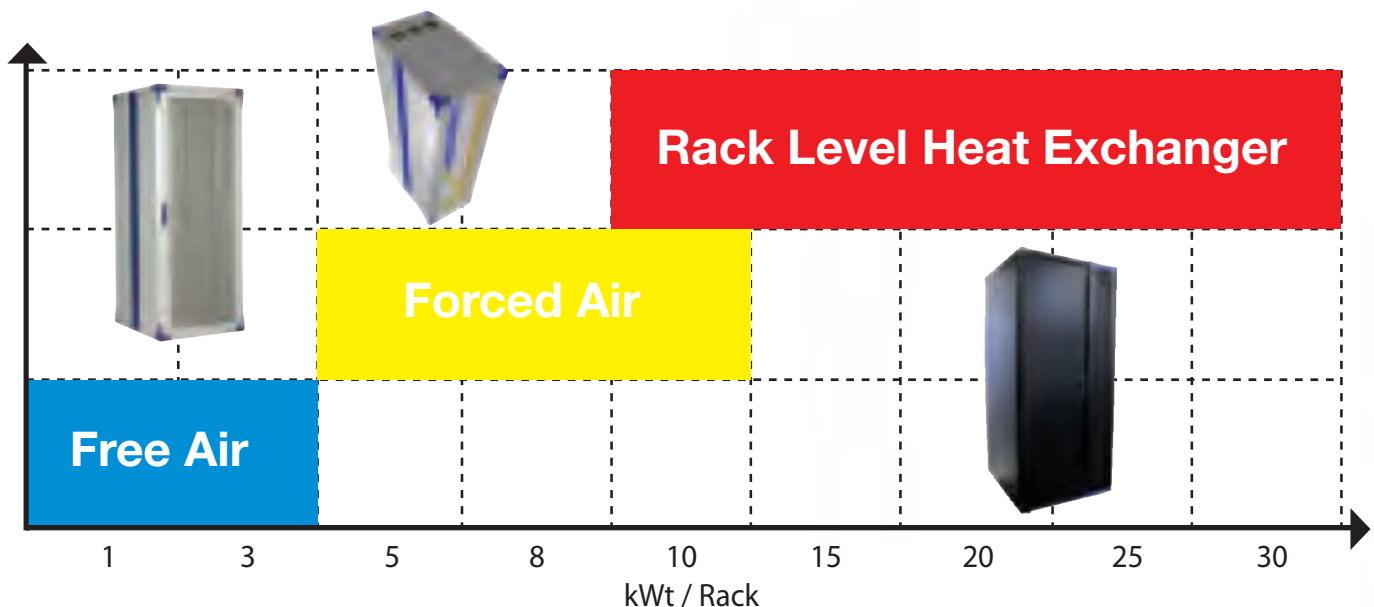

Option Overview

- Three standard heights. Other heights are available subject to order up to a maximum of 52U.
- Two standard widths of 600mm and 800mm with other options including 700mm wide assemblies subject to order.
- Three standard depth options including 875mm, 1000mm and 1200mm. Other depth options are available to order up to a maximum of 1400mm.

Finish Options

Cooper B-Line's Access cabinet is available in a range of standard colour options other than the default standard which is Colour Ref. A

- Light Grey with Blue Trim – Colour Ref. A

Other standard colour options include

- Black with Black Trim – Colour Ref. B
- Light Grey with Black Trim – Colour Ref. C
- Black with Blue Trim – Colour Ref. D
- Light Grey with Mid Grey Trim – Colour Ref. G

Custom colour options are also available subject to minimum order quantities and lead times

Accessories

A comprehensive range of accessories are available to suit every application. Details of specific items can be found on the pages indicated below;

■ Cabinet Cladding Enhancements	38
■ Floor Mounting Options	38
■ Base Cable Entry	38
■ Roof Cable Entry	38
■ Vertical Cable Management	76
■ Horizontal Cable Management	80
■ General Cable Management	82
■ Rack Mounted Thermal Management	89
■ Power Distribution	92
■ 19-Inch Blanking Panels	83
■ Shelf Options	72
■ Bolt Together Options	91
■ Earthing Accessories	90
■ Cabinet Light	113
■ Access Control	98
■ Environmental Monitoring	99
■ Cabinet Fire Suppression	110

Height	Width (mm)	Depth (mm)	Order Code (Assembled)	Order Code (Flat Packed)
27U	600	875	A2768C1CWPPXVA	A2768C1CWPPXVAK
		1000	A2761C1CWPPPVA	A2761C1CWPPPVAK
		1200	A2762C1CWPPPVA	A2762C1CWPPPVAK
42U	600	875	A4268C1CWPPXVA	A4268C1CWPPXVAK
		1000	A4261C1CWPPPVA	A4261C1CWPPPVAK
		1200	A4262C1CWPPPVA	A4262C1CWPPPVAK
47U	600	875	A4768C1CWPPXVA	A4768C1CWPPXVAK
		1000	A4761C1CWPPPVA	A4761C1CWPPPVAK
		1200	A4762C1CWPPPVA	A4762C1CWPPPVAK
27U	800	875	A2788C1CWPPXVA	A2788C1CWPPXVAK
		1000	A2781C1CWPPPVA	A2781C1CWPPPVAK
		1200	A2782C1CWPPPVA	A2782C1CWPPPVAK
42U	800	875	A4288C1CWPPXVA	A4288C1CWPPXVAK
		1000	A4281C1CWPPPVA	A4281C1CWPPPVAK
		1200	A4282C1CWPPPVA	A4282C1CWPPPVAK
47U	800	875	A4788C1CWPPXVA	A4788C1CWPPXVAK
		1000	A4781C1CWPPPVA	A4781C1CWPPPVAK
		1200	A4782C1CWPPPVA	A4782C1CWPPPVAK

Order codes denote std. light grey and blue finish.

Advanced Managed Distribution Frame

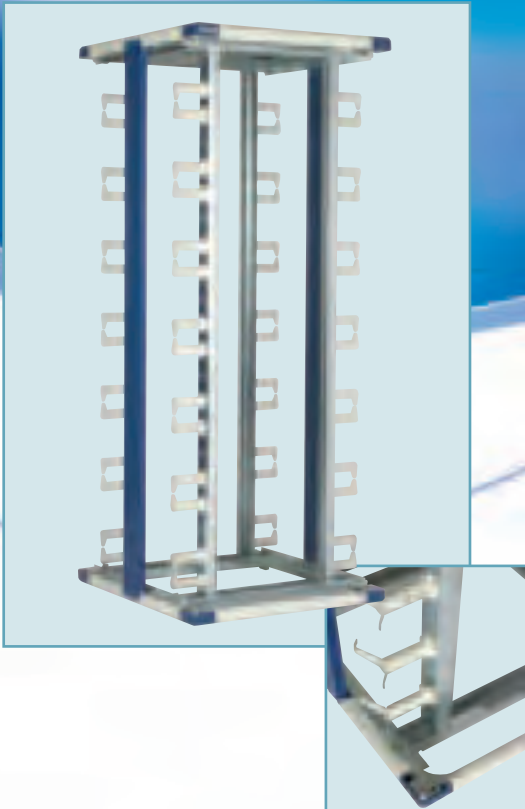

Introduction

The Access AMDF frame provides the perfect platform for high density copper and fibre patching applications. Providing unrivalled accessibility the basic frame structure can be easily and quickly adjusted as required.

The front and rear mounting angles on the 875mm and 1000mm deep variants can be removed allowing 110 Style Connector Mounting Frames to be easily fitted.

Advanced Managed Distribution Frame

Each unit is configured as follows;

- Basic Access frame with open apertures top and bottom for maximum unhindered cabling access.
- Fitted with standard corner adaptors and adjustable jacking feet.
- Supplied with two pairs of fully adjustable 19-inch mounting angles.
- Each mounting angle fitted with 10 off twist and lock cable management arms

The AMDF range is fully compatible with the Access range of accessories. The frames can also be retro fitted with doors and side panels for added security or to maintain an aesthetically pleasing appearance.

A wide range of cabling accessories are available to enhance the Access AMDF product. An overview of just some of these accessories is shown below

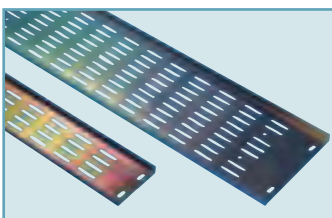

Access Cable Tray
– For further details
please see page 76

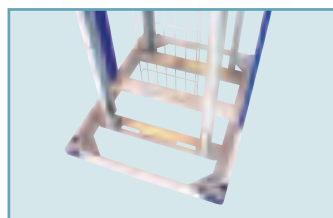

Front / Rear
Mounted Cable
Basket – For further
details please see
page 77

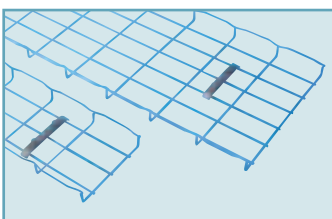

Access Cable
Basket – For further
details please see
page 77



Front / Rear
Mounted Velcro
Cable Tray
– For further details
please see page 77

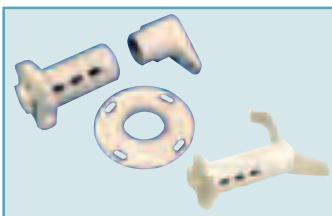

Access Twist &
Lock Arms – For
further details
please see page 82

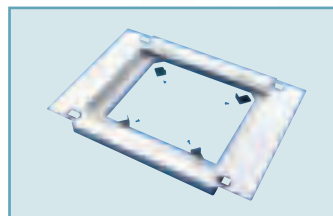

Access Computer
Floor Plinth – For
further details
please see page 59

Option Overview

- Two standard heights. Other heights are available subject to order up to a maximum of 52U.
- Available in 800mm wide configuration.
- Three standard depth options including 675mm, 875mm and 1000mm. Other depth options are available to order up to a maximum of 1400mm.

Finish Options

Cooper B-Line's Access cabinet is available in a range of standard colour options other than the default standard which is Colour Ref. A

- Light Grey with Blue Trim – Colour Ref. A

Other standard colour options include

- Black with Black Trim – Colour Ref. B
- Light Grey with Black Trim – Colour Ref. C
- Black with Blue Trim – Colour Ref. D
- Light Grey with Mid Grey Trim – Colour Ref. G

Custom colour options are also available subject to minimum order quantities and lead times

Accessories

A comprehensive range of accessories are available to suit every application. Details of specific items can be found on the pages indicated below;

■ Cabinet Cladding Enhancements	83
■ Floor Mounting Options	83
■ Base Cable Entry	83
■ Roof Cable Entry	83
■ Vertical Cable Management	76
■ Horizontal Cable Management	80
■ General Cable Management	82
■ Power Distribution	92
■ Blanking Panels	83
■ Shelf Options	72
■ Bolt Together Options	91
■ Earthing Accessories	90
■ Cabinet Light	113



Height	Width (mm)	Depth (mm)	Order Code (Assembled)	Order Code (Flat Packed)
42U	800	675	A4286AMDFA	A4286AMDFAK
		875	A4288AMDFA	A4288AMDFAK
		1000	A4281AMDFA	A4281AMDFAK
47U	800	675	A4786AMDFA	A4786AMDFAK
		875	A4788AMDFA	A4788AMDFAK
		1000	A4781AMDFA	A4781AMDFAK

Order codes denote std. light grey and blue finish.

Co-Locate / Multi Hosting Cabinet



Introduction

The Access Co-Locate / Multi Hosting cabinet range provides the perfect space saving solution allowing either two or three conventional rack spaces to be housed within a single cabinet foot print.

With individually keyed bays the Access Co-Locate cabinet offers the additional benefit of allowing tiered access control. By controlling the issue of keys administrators can limit users to either individuals or groups of bays. This functionality can be further enhanced with Cooper B-Line's i-PAL programmable electronic locking solution.

Multi Hosting / Co-Locate Access Cabinet

Each unit is configured as follows;

- Basic Access frame fitted with Nylon skids.
- Divider bar assembly (single divider bar on 2-bay variants and twin divider bars on 3-bay variants).
- Vented divider panel fitted to the divider bar assemblies.
- Supplied with 2 x pairs of independent fully adjustable 19-inch mounting angles in each bay.
- Fitted with vented steel doors front and rear with each pair of doors being individually keyed.
- Top panel configured as follows:
 - Fully vented panel fitted at the rear.
 - Remaining top panel aperture filled with plain panels.

Cladding Options Include

- Glazed Doors
- Plain Steel Doors
- Split Side Panels
- Fully Configurable Top Panel Assembly (using standard Access top panels).
- Configurable mechanical key, mechanical combination or electronic locking options

Height	Bays	Width (mm)	Depth (mm)	Order Code (Assembled)	Order Code (Flat Packed)
42U	2	600	875	A4268COLOC2A	A4268COLOC2AK
			1000	A4261COLOC2A	A4261COLOC2AK
			1200	A4262COLOC2A	A4262COLOC2AK
42U	3	600	875	A4268COLOC3A	A4268COLOC3AK
			1000	A4261COLOC3A	A4261COLOC3AK
			1200	A4262COLOC3A	A4262COLOC3AK
42U	2	800	875	A4288COLOC2A	A4288COLOC2AK
			1000	A4281COLOC2A	A4281COLOC2AK
			1200	A4282COLOC2A	A4282COLOC2AK
42U	3	800	875	A4288COLOC3A	A4288COLOC3AK
			1000	A4281COLOC3A	A4281COLOC3AK
			1200	A4282COLOC3A	A4282COLOC3AK

Order codes denote std. light grey and blue finish.

Details are subject to change without written notification.

Option Overview

- Available in both 42U and 47U standard heights. Other heights are available to order up to a maximum height of 52U.
- Available in 600mm and 800mm wide configurations.
- Three standard depth options including 875mm, 1000mm and 1200mm. Other depth options are available to order up to a maximum of 1400mm.
- Other cladding options are available subject to order.

Finish Options

Cooper B-Line's Access cabinet is available in a range of standard colour options other than the default standard which is Colour Ref. A

- Light Grey with Blue Trim – Colour Ref. A

Other standard colour options include

- Black with Black Trim – Colour Ref. B
- Light Grey with Black Trim – Colour Ref. C
- Black with Blue Trim – Colour Ref. D
- Light Grey with Mid Grey Trim – Colour Ref. G

Custom colour options are also available subject to minimum order quantities and lead times

Accessories

A comprehensive range of accessories are available to suit every application. Details of specific items can be found on the pages indicated below;

■ Cabinet Cladding Enhancements	38
■ Floor Mounting Options	38
■ Base Cable Entry	38
■ Roof Cable Entry	38
■ Vertical Cable Management	76
■ Horizontal Cable Management	80
■ General Cable Management	82
■ Rack Mounted Thermal Management	89
■ Power Distribution	92
■ Blanking Panels	83
■ Shelf Options	72
■ Bolt Together Options	91
■ Earthing Accessories	90
■ Cabinet Light	113
■ Access Control	98
■ Environmental Monitoring	99
■ Cabinet Fire Suppression	110
■ General Accessories	114

Internal Options Include

- Plain Divider Panels
- Vertical Cable Trays (independently mounted in each bay)
- Vertical Cable Basket (independently mounted in each bay)
- Secure Cabling Channels (800mm wide cabinets only)

Height	Bays	Width (mm)	Depth (mm)	Order Code (Assembled)	Order Code (Flat Packed)
47U	2	600	875	A4768COLOC2A	A4768COLOC2AK
			1000	A4261COLOC2A	A4261COLOC2AK
			1200	A4262COLOC2A	A4262COLOC2AK
47U	3	600	875	A4268COLOC3A	A4268COLOC3AK
			1000	A4261COLOC3A	A4261COLOC3AK
			1200	A4262COLOC3A	A4262COLOC3AK
47U	2	800	875	A4288COLOC2A	A4288COLOC2AK
			1000	A4281COLOC2A	A4281COLOC2AK
			1200	A4282COLOC2A	A4282COLOC2AK
47U	3	800	875	A4288COLOC3A	A4288COLOC3AK
			1000	A4281COLOC3A	A4281COLOC3AK
			1200	A4282COLOC3A	A4282COLOC3AK

Order codes denote std. light grey and blue finish.

3 into 2 Cabinet

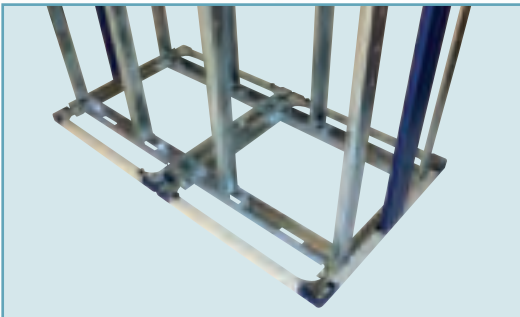

Introduction

Each assembly comprises of two 800mm wide specially configured Access cabinets bayed together. The unique corner less frame construction allows up to 3 sets of 19-inch mounting rails to be fitted within the footprint of two conventional 800mm wide cabinets. This arrangement allows up to 50% more equipment to be installed within the foot print normally taken by two conventional cabinets.

The assembly can be supplied with three sets of full depth 19-inch rails front and rear. For applications requiring vertical cable management to accommodate higher volumes of cabling, users may choose to have the assembly configured with three sets of 19-inch rails at the front and two sets of 19-inch rails at the rear.

Access 3 into 2 Cabinet

Each unit is configured as follows;

- Two specially configured Access 800mm wide frames each fitted with Nylon skids. Each frame has the centre vertical extrusion removed to facilitate full depth mounting in the centre bay position.
- Three sets of fully adjustable 19-inch mounting rails fitted at the front of the assembly.
- The choice of either two sets or three sets of fully adjustable 19-inch mounting angles fitted at the rear of the assembly.

Assembly cladding can be ordered separately as required. Examples of typical cladding arrangements are shown below.



Option Overview

- Available in both 42U and 47U standard heights. Other heights are available to order up to a maximum height of 52U.
- Available 800mm wide configurations.
- Three standard depth options are offered including 675mm, 875mm and 1000mm. Other depth options are available to order up to a maximum of 1400mm.
- Assembly cladding can be ordered and configured as required.

Finish Options

Cooper B-Line's Access cabinet is available in a range of standard colour options other than the default standard which is Colour Ref. A

- Light Grey with Blue Trim – Colour Ref. A

Other standard colour options include

- Black with Black Trim – Colour Ref. B
- Light Grey with Black Trim – Colour Ref. C
- Black with Blue Trim – Colour Ref. D
- Light Grey with Mid Grey Trim – Colour Ref. G

Custom colour options are also available subject to minimum order quantities and lead times

Accessories

A comprehensive range of accessories are available to suit every application. Details of specific items can be found on the pages indicated below;

■ Cabinet Cladding Enhancements	38
■ Floor Mounting Options	38
■ Base Cable Entry	38
■ Roof Cable Entry	38
■ Vertical Cable Management	76
■ Horizontal Cable Management	80
■ General Cable Management	82
■ Rack Mounted Thermal Management	89
■ Power Distribution	92
■ Blanking Panels	83
■ Shelf Options	72
■ Bolt Together Options	91
■ Earthing Accessories	90
■ Cabinet Light	113
■ Access Control	98
■ Environmental Monitoring	99
■ Cabinet Fire Suppression	110
■ General Accessories	114

Height	Sets of Front Rails	Sets of Rear Rails	Width (mm)	Depth (mm)	Order Code (Assembled)	Order Code (Flat Packed)
42U	3	2	1600	675	A4286DA	A4286DAK
				875	A4288DA	A4288DAK
				1000	A4281DA	A4281DAK
42U	3	3	1600	675	A4286EA	A4286EAK
				875	A4288EA	A4288EAK
				1000	A4281EA	A4281EAK
47U	3	2	1600	675	A4786DA	A4786DAK
				875	A4788DA	A4788DAK
				1000	A4781DA	A4781DAK
47U	3	3	1600	675	A4786EA	A4786EAK
				875	A4788EA	A4788EAK
				1000	A4781EA	A4781EAK

Order codes denote std. light grey and blue finish.

High Density Copper Cabling Cabinet



Introduction

The Access High Density Cabling Cabinet is the first cabinet designed to solve the problems of today's networking environment. It provides unique working and cabling accessibility to totally transform cabinet installation layouts, onsite installation time and on-going systems management.

The unique open architecture construction of the corner-less design coupled with the ability to quickly remove all of the external cladding provides the ability to create an installation that is far neater and more user friendly. Compared with conventional cabinets, systems can be deployed far more quickly without compromising the quality of the installation.

The cabinet promotes the maintenance of bend radii including requirements for Category 6A cabling further helping to avoid messy, un-workable cabling arrangements.

The Access HDC cabinet's open frame structure provides virtually 360° total accessibility, prior to fitting panels and doors, which gives installers maximum working access and the opportunity to greatly improve installation times. The elimination of corner posts also removes the need to excessively inset 19" mounting angles, achieving maximum working space.

The unique design of the enclosure, which is 900mm wide and 500mm deep, allows extra space for cable management each side of the 19-inch mounting angles. The 19-inch mounting angles are designed with finger cable management every 1U on both sides allowing for complete support of patch cords so that no "U" space is wasted with cable management bars.

Access High Density Copper Cabling Cabinet

Each unit is configured as follows;

- Basic frame fitted with nylon feet.
- 1 x Pair of full adjustable 19-inch rails fitted with RCM+ fingers.
- 20 x Twist and lock cable management arms (10 per 19-inch rail)
- Single piece plain top panel.
- 2 x Pairs of plain side panels.
- Single piece plain steel rear door.
- Double plain steel front door.



Access HDCC Cabinet

Description	Packaging	Order Code
Access High Density Copper Cabling Cabinet - 42U x 900mm Wide x 500mm Deep as per standard specification.	Pallet/Flat Pack**	HD420905C8CYSP1NNA
Access High Density Copper Cabling Cabinet - 47U x 900mm Wide x 500mm Deep as per standard specification.	Pallet/Flat Pack**	HD470905C8CYSP1NNA

** Flat packed subject to additional charge

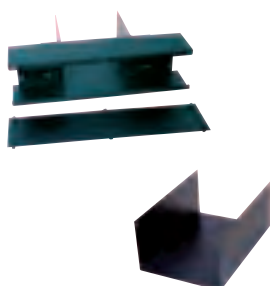

Access HDCC Cable Through Trough

Description	Packaging	Order Code
Access High Density 3U Cable Trough Assembly	Fitted/Special	HD3UCTA
Access High Density 3U Cable Trough Extender - Allows troughs to be coupled up when cabinets are bayed back to back.	Fitted/Special	HD3UCTEA

order codes denote std. light grey and blue finish.

Details are subject to change without written notification.

Option Overview

- Available in 42U and 47U standard height options.
- Optional cable through troughs.
- Access High Density Cabling Cabinet 2-Bay Computer Floor Plinth
- To suit 900mm wide x 500mm deep AHDCS Assemblies (back to back baying).

Finish Options

- Panels painted light grey NCS 1502-Y and mouldings and extrusions in blue NCS 4550-R90B.
- Plated items Zinc and Trivalent Passivate to BS EN 12329:2000.
- Custom colour options are also available subject to minimum order quantities and lead times
- Available fully assembled and palletised as standard with flat pack available upon request.

Accessories

A comprehensive range of accessories are available to suit every application. Details of specific items can be found on the pages indicated below;

■ Vertical Cable Management	76
■ Horizontal Cable Management	80
■ Power Distribution	92
■ 19-Inch Blanking Panels	83
■ Shelf Options	72
■ Earthing Accessories	90
■ Cabinet Light	113
■ Access Control	98
■ Environmental Monitoring	99
■ Cabinet Fire Suppression	110

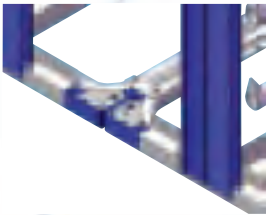

Access HDCC Bolt Together Kit

Description	Packaging	Order Code
Access High Density Cabinet Baying Kit	Bagged	HDBKA



Access HDCC Baying Side Panel

Description	Packaging	Order Code
Access High Density Cabling Cabinet - 42U x 500mm Deep Plain Double Side Panel (fills in the centre side panel aperture when baying two HDCC cabinets back to back)	Special	HDPDSP425A
Access High Density Cabling Cabinet - 47U x 500mm Deep Plain Double Side Panel (fills in the centre side panel aperture when baying two HDCC cabinets back to back)	Special	HDPDSP475A

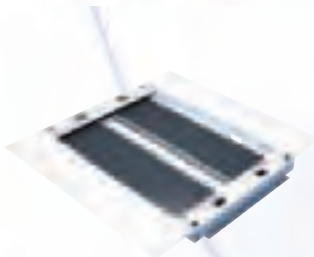

Access HDCC Cabinet Computer Floor Plinth

Description	Packaging	Order Code
Access High Density Cabling Cabinet 2-Bay Computer Floor Plinth to suit 900mm wide x 500mm deep. AHDCS Assemblies (back to back baying)	Special	HD2BFP95A

Order codes denote std. light grey and blue finish.

Details are subject to change without written notification.

High Density Fibre Cabling Cabinet



Features

The Access High Density Fibre Cabling Cabinet has been further developed to meet the exacting needs demanded by high density fibre cabling installations. Capitalising on the strength and modularity of the Access Cabinet design, the internal cabinet envelope can be configured to provide a range of mounting configurations including standard 19-inch.

Sharing the same key attributes of a conventional Access cabinet, the corner less open architecture frame allows for secure but easy removal of all external cladding in a matter of seconds. This feature provides the platform to allow cables to be installed far more quickly without compromising the integrity of the cables or connectors. The resultant installation allows safe bend radii to be maintained whilst at the same time avoiding messy, haphazard cabling arrangements.

The unique design of the enclosure, which is 900mm wide and 500mm deep, together with the ability to offset the mounting angles enables the provision for cable management to be incorporated easily. A range of standard options including cable management spools, cable supports, cable troughs and cable ties are available to enhance the design.

- Specifically designed for high density fibre cabling installations.
- Full 360° cabling access thanks to the quick release cladding.
- Fully integrated cable management (RCM+ fingers, cable spools etc.).
- Optional cable through troughs.
- Unhindered cable top or bottom cable entry.
- Unrivalled cabling access with easy access for front to rear cabling down the sides of the cabinet.

Cabinet Specifications

Access High Density Fibre Cabling Cabinet

Each unit is configured as follows;

- Basic frame fitted with nylon feet.
- 1 x Pair of full adjustable 19-inch rails fitted with RCM+ fingers on right hand mounting angle only.

- Vertical cable manager fitted with 8 off cable spools.
- Single piece plain top panel.
- 2 x Pairs of plain side panels.
- Single piece plain steel rear door.
- Double plain steel front door.

Benefits

- Designed to be compliant with conventional fibre cabling requirements.
- Totally open construction for ease of cross-patching.
- Reduced installation time.
- Cabling installations made easy.
- Maximum useable space.
- Unrivalled working access.
- Excellent cabling accessories.
- Flexible panel configurations.

Specification

- 42U and 47U standard height options.
- Available in 900mm width & 500mm depth option as standard.

Standard Finish:

- Panels painted light grey NCS 1502-Y and mouldings and extrusions in blue NCS 4550-R90B.
- Plated items Zinc and Trivalent Passivate to BS EN 12329:2000.
- Available fully assembled and palletised as standard with flat pack available upon request.
- Weight load capacity 1000kg.
- IP Rating – IP20



Access HDCC Fibre Cabling Cabinet

Description	Packaging	Order Code
Access High Density Fibre Cabling Cabinet - 42U x 900mm Wide x 500mm Deep as per standard specification.	Pallet / Flat Pack**	HF420905C8CYSP1NNA
Access High Density Fibre Cabling Cabinet - 47U x 900mm Wide x 500mm Deep as per standard specification.	Pallet / Flat Pack**	HF470905C8CYSP1NNA

** Flat packed subject to additional charge

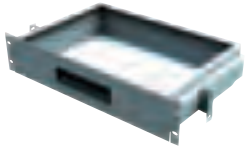

Drawer Unit

Access HDCC Fibre Cable Storage Drawers

Description	Packaging	Order Code
Access High Density 19-inch 2U Sliding Storage drawer unit	Fitted / Special	HF19DU2UA
Access High Density 19-inch 3U Sliding Storage drawer unit	Fitted / Special	HF19DU3UA



Horizontal Cable Manager

Access HDCC Horizontal Cable Managers

Description	Packaging	Order Code
19-Inch 1U Horizontal Cable Management Panel With Hinged Cover	Individually Boxed	SB-870-19S-1FB
19-Inch 2U Horizontal Cable Management Panel With Hinged Cover	Individually Boxed	SB-870-19S-2FB
19-Inch 3U Horizontal Cable Management Panel With Hinged Cover	Individually Boxed	SB-870-19S-3FB



Cable Spool Arms

Access HDCC Fibre Cabling Accessories

Description	Packaging	Order Code
Cable Spool Arms	Fitted / Special	SB-860-7SP FB
Cable Strap Mount Fixings	Bagged Pack Of 100	SB-862-PIF
Cable Strap Mount	Bagged Pack Of 100	SB-862-CSM
Cable Wrap (Yellow Nylon) 16mm x 127mm	Supplied as single pieces	SB72558x5
Cable Wrap (Yellow Nylon) 25mm x 254mm	Supplied as single pieces	SB7251x10
Cable Catch (Grey Nylon) 16mm x 101mm	Supplied as single pieces	SB72658x4
Cable Catch (Grey Nylon) 25mm x 203mm	Supplied as single pieces	SB7261x8
Cable Strap (Grey Nylon) 16mm x 152mm	Supplied as single pieces	SB72758x6
Cable Hanger (Grey Nylon) 19mm x 152mm	Supplied as single pieces	SB72834x6



Cable Strap Mount Fixings

Access HDCC Fibre Cabling Cabinet Bayed Side Panel

Description	Packaging	Order Code
Access High Density Cabling Cabinet - 42U x 500mm Deep Plain Double Side Panel (fills in the centre side panel aperture when baying two HDCC cabinets back to back)	Special	HDPDSP425A
Access High Density Cabling Cabinet - 47U x 500mm Deep Plain Double Side Panel (fills in the centre side panel aperture when baying two HDCC cabinets back to back)	Special	HDPDSP475A



Cable Strap Mount

Access HDCC

Description	Packaging	Order Code
Access High Density Cabinet Baying Kit	Bagged	HDBKA



Velcro Cable Ties

Access HDCC Cabinet Computer Floor Plinth

Description	Packaging	Order Code
Access High Density Cabling Cabinet 2-Bay Computer Floor Plinth To Suit 900mm wide x 500mm deep AHDCC Assemblies (back to back baying)	Special	HD2BFP95A

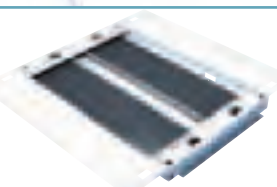

2-Bay Computer Floor Plinth

High Density Server Cabinet



Single Feed Option



Dual Feed Option

System Features

Cooper B-Line's i -ACE, a side mounted intelligent heat exchanger unit is designed to provide closed loop 20kW cooling duty.

Using proven chilled water technology, i -ACE continues Cooper B-Line's philosophy of offering scalable solutions designed to grow with demand.

i -ACE has been designed as a 300mm wide module allowing two units mounted side by side to take up one 600mm wide floor tile space. The i-ACE unit cladding can be configured to provide either left hand or right hand mounted operation. This also allows users to have the cladding configured to service two adjacent enclosures, providing 50% duty to each cabinet.

Standard Features:-

- Modular upgrade to any 42U / 47U Access Cabinet with a depth of 1000mm or more.
- True 20kW Duty.
- 300mm wide foot print allowing two units to mount on a 600mm tile space.
- Single or dual cabinet configuration capability including N+1 redundancy.
- Option to integrate internal sensors to Cooper B-Line's i -BOX to provide network configurable access and remote monitoring functionality.
- Hot swappable fan units.
- Colour options (Black RAL 9005 with blue trim as standard)
- Aesthetic design that enhances the Access cabinet range.

Cabinet Specification

Each single feed cabinet comprises of the following;

- Basic frame fitted with 4 x adjustable jacking feet
- 2 x Pairs of fully adjustable 19-inch mounting angles.
- 1 x Pair of brush strip vertical baffles (fitted at the front on server configurations and staggered front left and rear right on mixed technology configurations).
- Base panel fitted with 2 x plain panels and 2 x brush strip entry panels.
- Top panel assembly comprising comprising of a single brush strip entry panel fitted at the rear with the remaining aperture space filled with plain panels.
- 1 x Pair of plain side panels fitted to one side of the cabinet (left hand side if the heat exchanger is mounted to the right hand side and right hand side if the heat exchanger is fitted to the left hand side).
- 1 x Single piece heater exchanger mounting panel.
- 1 x Plain steel rear door.
- 1 x Plain glazed front door.

Benefits

- Easy deployment with quick coupling connectors and flexible hoses.
- Optional installation and commissioning service.
- Fully compatible with 42U/47U height units and can be configured to suit 1000mm + depth cabinets.
- Efficient.

Specification & Performance

■ Duty	20kW
■ Airflow rate	1 m ³ /s
■ Delivery air temperature	18°C
■ Return air temperature	35°C
■ Fluid flow rate	1.0 l/s
■ Fluid inlet temperature	10°C
■ Fluid outlet temperature	15°C
■ Weight	175kg (commissioned)

i-ACE System Operation

The delivery air temperature is monitored and this information is used to modulate a three way valve on the fluid supply which in turn varies the cooling capacity of the heat exchanger. In the event of low cooling demand the three way valve isolates the i-ACE heat exchanger from the chiller circuit. This has the effect of reducing cooling demands on the chiller which in turn improves the chiller efficiency and reduces power consumption.

At low cooling levels the fan speed is reduced, lowering power consumption. Some air flow within the system is advantageous as this helps to avoid condensation build up.

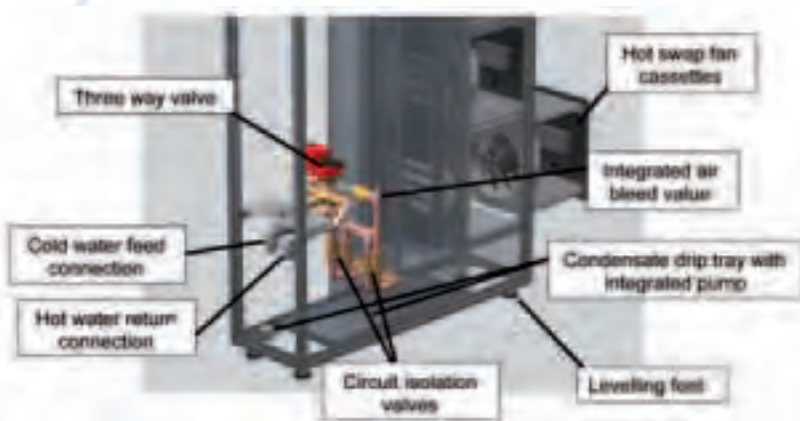

Fig 1.1 – i-ACE Internal Configuration



Multiple Cabinet Array

High Density Server Cabinet Cont.

i-ACE System Design

The i -ACE unit incorporates a finned heat exchanger to cool a re-circulating airflow from an adjacent server cabinet. The i -ACE unit may be mounted on either side of a server cabinet, or when situated between two cabinets, can serve both at 50% cooling capacity each.

The chilled water flows through the heat exchanger which comprises two coil sections, each piped independently and fitted with separate isolation valves enabling the unit to continue to run at 50% capacity in the unlikely event of a circuit failure. The exchanger construction is copper tube with aluminium fin, and galvanised steel casework.

The air movement is provided by up to five separate fans which can be hot swapped in service. On smaller cooling duties fewer fans can be installed. Air return baffles are positioned at the rear of every fan aperture to stop leakage in the event of a fan cassette being removed. The fans are inserted and removed at the front of the unit with access only available via a lockable access panel.

The removable carriage containing the fan includes overload protection for each individual fan. There are handles to aid the removal of individual fan cassettes.

Power supply

The equipment within the i -ACE unit operates on 24V dc. A switch mode power supply is installed in the top section of the unit. This has an input supply range of 85 – 270V (0-66Hz) (or 120 – 400V dc). At full load the i -ACE unit consumes 300W of power.

Monitoring

An independent monitoring system is provided based on the i -BOX technology. Each mode has up to two sensors as follows:

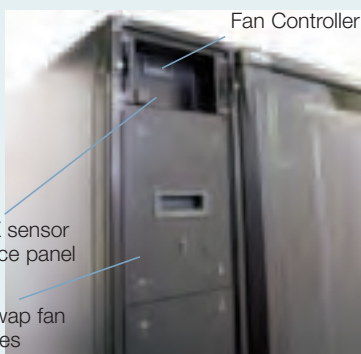

Fig 1.2 – i -ACE Sensor Interface

1. Fan 1 Speed	Return air temperature at Fan 1
2. Fan 2 Speed	Return air temperature at Fan 2
3. Fan 3 Speed	Return air temperature at Fan 3
4. Fan 4 Speed	Return air temperature at Fan 4
5. Fan 5 Speed	Return air temperature at Fan 5
6. Water Leakage	Integrated flood sensor
7. Outlet Water Temperature	Water Flow Rate
8. Inlet Water Temperature	Integrated temperature sensor
9. Outlet Air Temperature	Integrated temperature sensor
10. Front and Rear Panel Access Monitor	Integrated panel contact sensor.

i-ACE Finish Options

The enclosure is made up of an extruded aluminium framework with colour configurable external panels (internal panels are black RAL9005 as standard). The external cladding can easily be removed once access has been gained through the front and rear cover panels. This provides the ability to service the i-ACE heat exchanger in position in the unlikely event of a malfunction.

Colour configurations include:

Standard

- Black RAL9005 with blue trim.

Options

- Light grey NCS 1502-Y with blue trim.
- Light grey NCS 1502-Y with mid grey trim.

Heat Exchanger Order Codes

Description	Standard Finishing	Packaging	Order Code
Access Cabinet 47U x 1000mm Deep 20kW Heat Exchanger Assembly for LH Mounting Complete With Cladding Panels	Black with Blue trim	Crated	AC471020KWHELHB
Access Cabinet 47U x 1000mm Deep 20kW Heat Exchanger Assembly for RH Mounting Complete With Cladding Panels	Black with Blue trim	Crated	AC471020KWHERHB
Access Cabinet 47U x 1000mm Deep 20kW Heat Exchanger Assembly for Dual Feed Mounting Complete With Cladding Panels	Black with Blue trim	Crated	AC471020KWHEDFB
Access Cabinet 42U x 1000mm Deep 20kW Heat Exchanger Assembly for LH Mounting Complete With Cladding Panels	Black with Blue trim	Crated	AC421020KWHELHB
Access Cabinet 42U x 1000mm Deep 20kW Heat Exchanger Assembly for RH Mounting Complete With Cladding Panels	Black with Blue trim	Crated	AC421020KWHERHB
Access Cabinet 42U x 1000mm Deep 20kW Heat Exchanger Assembly for Dual Feed Mounting Complete With Cladding Panels	Black with Blue trim	Crated	AC421020KWHEDFB
Access Cabinet 42U x 1200mm Deep 20kW Heat Exchanger Assembly for LH Mounting Complete With Cladding Panels	Black with Blue trim	Crated	AC421220KWHELHB
Access Cabinet 42U x 1200mm Deep 20kW Heat Exchanger Assembly for RH Mounting Complete With Cladding Panels	Black with Blue trim	Crated	AC421220KWHERHB
Access Cabinet 42U x 1200mm Deep 20kW Heat Exchanger Assembly for Dual Feed Applications Complete With Cladding Panels	Black with Blue trim	Crated	AC421220KWHEDFB
Access Cabinet 47U x 1200mm Deep 20kW Heat Exchanger Assembly for LH Mounting Complete With Cladding Panels	Black with Blue trim	Crated	AC471220KWHELHB
Access Cabinet 47U x 1200mm Deep 20kW Heat Exchanger Assembly for RH Mounting Complete With Cladding Panels	Black with Blue trim	Crated	AC471220KWHERHB
Access Cabinet 47U x 1200mm Deep 20kW Heat Exchanger Assembly for Dual Feed Applications Complete With Cladding Panels	Black with Blue trim	Crated	AC471220KWHEDFB



High Density Server Cabinet Cont.

Dual feed cabinet configurations

Are as per the single feed configuration but with the standard side panels removed and replaced by a second single piece heat exchanger mounting panel.

Server Cabinet Configurations

Description	Finish	Order Code (Assembled)	Order Code (Flat Packed)
Access 42U x 600mm wide a 1000mm deep High Density Left Hand Feed Server Cabinet	Black RAL 9005	A4261HDLFSCB	A4261HDLFSCBK
Access 42U x 600mm wide a 1000mm deep High Density Right Hand Feed Server Cabinet	Black RAL 9005	A4261HDRFSCB	A4261HDRFSCBK
Access 42U x 600mm wide a 1000mm deep High Density Dual Feed Server Cabinet	Black RAL 9005	A4261HDDFSCB	A4261HDDFSCBK
Access 42U x 600mm wide a 1200mm deep High Density Left Hand Feed Server Cabinet	Black RAL 9005	A4262HDLFSCB	A4262HDLFSCBK
Access 42U x 600mm wide a 1200mm deep High Density Right Hand Feed Server Cabinet	Black RAL 9005	A4262HDRFSCB	A4262HDRFSCBK
Access 42U x 600mm wide a 1200mm deep High Density Dual Feed Server Cabinet	Black RAL 9005	A4262HDDFSCB	A4262HDDFSCBK
Access 47U x 600mm wide a 1000mm deep High Density Left Hand Feed Server Cabinet	Black RAL 9005	A4761HDLFSCB	A4761HDLFSCBK
Access 47U x 600mm wide a 1000mm deep High Density Right Hand Feed Server Cabinet	Black RAL 9005	A4761HDRFSCB	A4761HDRFSCBK
Access 47U x 600mm wide a 1000mm deep High Density Dual Feed Server Cabinet	Black RAL 9005	A4761HDDFSCB	A4761HDDFSCBK
Access 47U x 600mm wide a 1200mm deep High Density Left Hand Feed Server Cabinet	Black RAL 9005	A4762HDLFSCB	A4762HDLFSCBK
Access 47U x 600mm wide a 1200mm deep High Density Right Hand Feed Server Cabinet	Black RAL 9005	A4762HDRFSCB	A4762HDRFSCBK
Access 47U x 600mm wide a 1200mm deep High Density Dual Feed Server Cabinet	Black RAL 9005	A4762HDDFSCB	A4762HDDFSCBK



Cabinet Specifications

Each single feed cabinet comprises of the following;

- Basic frame fitted with 4 x adjustable jacking feet
- 2 x Pairs of fully adjustable 19-inch mounting angles.
- 1 x Pair of brush strip vertical baffles (fitted at the front on server configurations and staggered front left and rear right on mixed technology configurations).
- Base panel fitted with 2 x plain panels and 2 x brush strip entry panels.
- Top panel assembly comprising of single brush strip entry panel fitted at the rear with the remaining aperture space filled with plain panels.
- 1 x Pair of plain side panels fitted to one side of the cabinet (left hand side if the heat exchanger is mounted to the right hand side and right hand side if the heat exchanger is fitted to the left hand side).
- 1 x Single piece heater exchanger mounting panel.
- 1 x Plain steel rear door.
- 1 x Plain glazed front door.

Mixed Technology Cabinet Configurations

Description	Finish	Order Code (Assembled)	Order Code (Flat Packed)
Access 42U x 800mm wide a 1000mm deep High Density Left Hand Feed Server Cabinet	Black RAL 9005	A4281HDLFSCB	A4281HDLFSCBK
Access 42U x 800mm wide a 1000mm deep High Density Right Hand Feed Server Cabinet	Black RAL 9005	A4281HDRFSCB	A4281HDRFSCBK
Access 42U x 800mm wide a 1000mm deep High Density Dual Feed Server Cabinet	Black RAL 9005	A4281HDDFSCB	A4281HDDFSCBK
Access 42U x 800mm wide a 1200mm deep High Density Left Hand Feed Server Cabinet	Black RAL 9005	A4282HDLFSCB	A4282HDLFSCBK
Access 42U x 800mm wide a 1200mm deep High Density Right Hand Feed Server Cabinet	Black RAL 9005	A4282HDRFSCB	A4282HDRFSCBK
Access 42U x 800mm wide a 1200mm deep High Density Dual Feed Server Cabinet	Black RAL 9005	A4282HDDFSCB	A4282HDDFSCBK
Access 47U x 800mm wide a 1000mm deep High Density Left Hand Feed Server Cabinet	Black RAL 9005	A4781HDLFSCB	A4781HDLFSCBK
Access 47U x 800mm wide a 1000mm deep High Density Right Hand Feed Server Cabinet	Black RAL 9005	A4781HDRFSCB	A4781HDRFSCBK
Access 47U x 800mm wide a 1000mm deep High Density Dual Feed Server Cabinet	Black RAL 9005	A4781HDDFSCB	A4781HDDFSCBK
Access 47U x 800mm wide a 1200mm deep High Density Left Hand Feed Server Cabinet	Black RAL 9005	A4782HDLFSCB	A4782HDLFSCBK
Access 47U x 800mm wide a 1200mm deep High Density Right Hand Feed Server Cabinet	Black RAL 9005	A4782HDRFSCB	A4782HDRFSCBK
Access 47U x 800mm wide a 1200mm deep High Density Dual Feed Server Cabinet	Black RAL 9005	A4782HDDFSCB	A4782HDDFSCBK



Cabinet Specifications

Each single feed cabinet comprises of the following;

- Basic frame fitted with 4 x adjustable jacking feet
- 2 x Pairs of fully adjustable 19-inch mounting angles.
- 1 x Pair of brush strip vertical baffles (fitted at the front on server configurations and staggered front left and rear right on mixed technology configurations).
- Base panel fitted with 2 x plain panels and 2 x brush strip entry panels.
- Top panel assembly comprising of single brush strip entry panel fitted at the rear with the remaining aperture space filled with plain panels.
- 1 x Pair of plain side panels fitted to one side of the cabinet (left hand side if the heat exchanger is mounted to the right hand side and right hand side if the heat exchanger is fitted to the left hand side).
- 1 x Single piece heater exchanger mounting panel.
- 1 x Plain steel rear door.
- 1 x Plain glazed front door.

Cold Aisle Containment

Features

Cooper B-Line's i-ACS system continues the design philosophy of supplying modular solutions developed to grow with demand. Designed to be fully compatible with the industry leading Access Cabinet range, the i-ACS solution can be easily deployed into both new and existing sites.

The flexibility of the design also allows Cooper B-Line to supply solutions to fit third party racks and enclosures from other equipment manufacturers.

- Standard options to fit 42U & 47U Access Cabinets.
- Standard designs allowing flexibility of aisle spacing:-
- 1100mm to 1200mm aisle spacing option.
- 1700mm to 1800mm aisle spacing option.

Fully or partially glazed roof panels allowing light penetration and the integration of fire monitoring and suppression systems.

Double sliding doors provide easy access without compromising room layouts.

Optional accessories including cable through panels and bulk head lighting.

Choice of door locking options including mechanical and electronic locking.

No trip hazard at the door threshold.

Option of fully or partially glazed doors allowing light penetrations as well as unobscured view of the aisle space.

Can be configured to provide cable management options between bayed cabinets as well as above the aisle spacing.

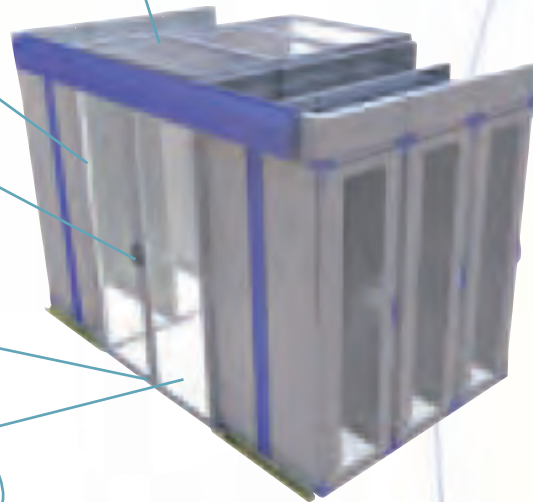

Benefits

- No need to order special cabinets as the system fits to standard Access cabinets.
- Fits both new and existing Access cabinet deployments.
- Wide range of engineered options.
- Optional installation and commissioning service.
- Modular design allows installations be expanded or contracted easily.
- Significantly improves cooling efficiencies allowing reduced operational costs or the option of increasing equipment densities.

Specification

Doors:

- Aluminium framed mounted onto sliding guide rails.
- Non locking, key locking, mechanical combination and electronic locking options.
- Clear perspex glazed panels for improved light penetration.

Roof Panels:

- Aluminium framed assembly on adjustable aisle spacing and sliding panel options.
- Steel frame option for fixed aisle spacing options.
- Clear perspex glazed panels for improved light penetration.

Why Use Cold Aisle Containment?

In today's environment where technology compaction is leading to higher computing densities, the need for not only adequate but also efficient cooling systems continues to be of growing importance.

At one time businesses may have considered simply reducing the number of active equipment units deployed in each rack space. With increasing energy, labour and real estate costs this is no longer an option, other solutions need to be found.

What's the right solution? There is no single solution that fits every application as each site will have different constraints and demands. The one thing that each site will have in common is that by avoiding hot and cold air crossover the cooling infrastructure will run more efficiently leading to lower operational costs and / or improved densities.

In a conventional data room environment configured in a "hot aisle" / "cold aisle" layout, the Computer Room Air Conditioning units (CRAC units) perform the function of collecting warm air (return air) from the local ambient environment. This return air is then cooled by the CRAC unit before being circulated back into the room environment. Where a raised computer floor is employed in the data room it is quite usual for the cold air feed from the CRAC unit to be fed under the floor to create a pressurised floor void. In this scenario vented floor tiles are deployed in strategic locations allowing cold air to be forced up into the "cold aisle", allowing the active equipment to draw the cold air across the electronics to cool them. The hot air is then expelled out the rear of the cabinet into the "hot aisle".

Whilst this provides a cooling mechanism it is clear to see a number of drawbacks in the layout;

1. The cold air feed is free to mix with the local ambient air leading to a rise in temperature of the cold air which in turn reduces the cooling efficiency of the air.
2. The cold air feed can bypass the active equipment completely, simply circulating back to the CRAC unit.
3. The hot air exhausted from the rear of the cabinet can easily be drawn back into the front of the cabinet, potentially leading to the generation of hot spots.

Cold aisle containment effectively takes care of a number of these issues as both the feed air and the return air are segregated. As a consequence the full cooling potential of the cold air is utilised, providing improved cooling and operational efficiency.

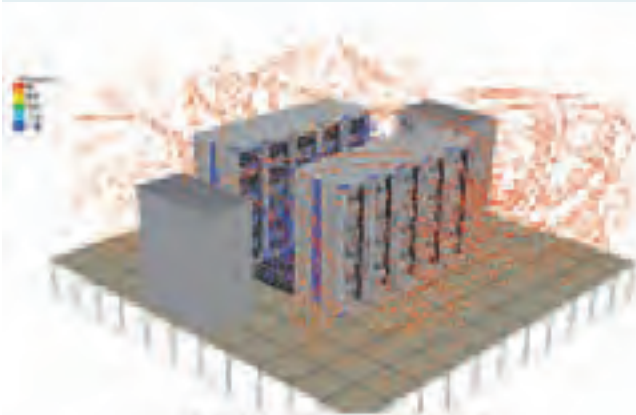

Cold Aisle Containment

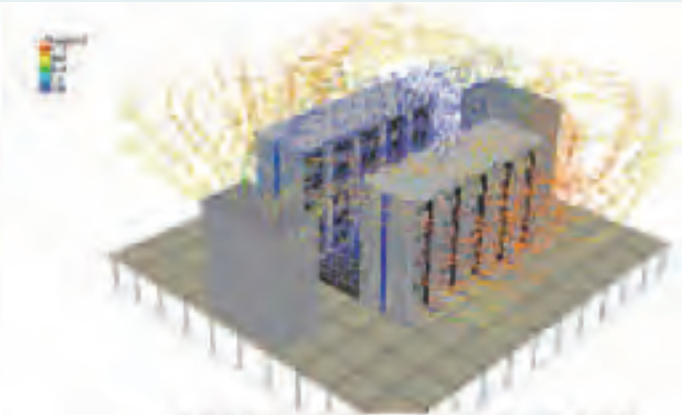

Conventional Hot Aisle / Cold Aisle

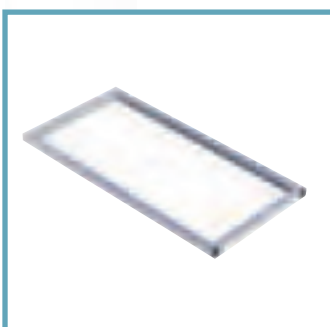

Various Glazed Roofing Options



Overhead Cable Management



Aisle Containment Sliding Doors

Cold Aisle Containment Cont.

Order Code	Description	Packaging
Sliding Glazed Roof Panel		
AACSRP1203SPCLA	Access Aisle Containment Sliding Perspex Glazed Roof Panel - To suit 1200mm fixed aisle spacing to suit a 300mm wide cabinet unit.	Supplied Flat Packed
AACSRP1206SPCLA	Access Aisle Containment Sliding Perspex Glazed Roof Panel - To suit 1200mm fixed aisle spacing to suit a 600mm wide cabinet unit.	Supplied Flat Packed
AACSRP1208SPCLA	Access Aisle Containment Sliding Perspex Glazed Roof Panel - To suit 1200mm fixed aisle spacing to suit a 800mm wide cabinet unit.	Supplied Flat Packed
AACSRP1209SPCLA	Access Aisle Containment Sliding Perspex Glazed Roof Panel - To suit 1200mm fixed aisle spacing to suit a 900mm wide cabinet unit.	Supplied Flat Packed
AACSRP1803SPCLA	Access Aisle Containment Sliding Perspex Glazed Roof Panel - To suit 1800mm fixed aisle spacing to suit a 300mm wide cabinet unit.	Supplied Flat Packed
AACSRP1806SPCLA	Access Aisle Containment Sliding Perspex Glazed Roof Panel - To suit 1800mm fixed aisle spacing to suit a 600mm wide cabinet unit.	Supplied Flat Packed
AACSRP1808SPCLA	Access Aisle Containment Sliding Perspex Glazed Roof Panel - To suit 1800mm fixed aisle spacing to suit a 800mm wide cabinet unit.	Supplied Flat Packed
AACSRP1809SPCLA	Access Aisle Containment Sliding Perspex Glazed Roof Panel - To suit 1800mm fixed aisle spacing to suit a 900mm wide cabinet unit.	Supplied Flat Packed
Adjustable Aisle Glazed Roof Panel		
AACSRP1203AFCLA	Access Aisle Containment Adjustable Perspex Glazed Roof Panel – To suit an aisle spacing from 1000mm – 1200mm and to suit a 300mm wide cabinet unit.	Supplied Flat Packed
AACSRP1206AFCLA	Access Aisle Containment Adjustable Perspex Glazed Roof Panel – To suit an aisle spacing from 1000mm – 1200mm and to suit a 600mm wide cabinet unit.	Supplied Flat Packed
AACSRP1208AFCLA	Access Aisle Containment Adjustable Perspex Glazed Roof Panel – To suit an aisle spacing from 1000mm – 1200mm and to suit a 800mm wide cabinet unit.	Supplied Flat Packed
AACSRP1209AFCLA	Access Aisle Containment Adjustable Perspex Glazed Roof Panel – To suit an aisle spacing from 1000mm – 1200mm and to suit a 900mm wide cabinet unit.	Supplied Flat Packed
AACSRP1803AFCLA	Access Aisle Containment Adjustable Perspex Glazed Roof Panel – To suit an aisle spacing from 1600mm – 1800mm and to suit a 300mm wide cabinet unit.	Supplied Flat Packed
AACSRP1806AFCLA	Access Aisle Containment Adjustable Perspex Glazed Roof Panel – To suit an aisle spacing from 1600mm – 1800mm and to suit a 600mm wide cabinet unit.	Supplied Flat Packed
AACSRP1808AFCLA	Access Aisle Containment Adjustable Perspex Glazed Roof Panel – To suit an aisle spacing from 1600mm – 1800mm and to suit a 800mm wide cabinet unit.	Supplied Flat Packed
AACSRP1809AFCLA	Access Aisle Containment Adjustable Perspex Glazed Roof Panel – To suit an aisle spacing from 1600mm – 1800mm and to suit a 900mm wide cabinet unit.	Supplied Flat Packed
Cable Channel Top Panel Assembly		
AACSCC06STA	Access Aisle Containment System – 600mm Wide Standard Cable Channel with Brush Strip Entry	Supplied Individually Wrapped
AACSCC08STA	Access Aisle Containment System – 800mm Wide Standard Cable Channel with Brush Strip Entry	Supplied Individually Wrapped
AACSCC09STA	Access Aisle Containment System – 900mm Wide Standard Cable Channel with Brush Strip Entry	Supplied Individually Wrapped
Overhead Cable Basket Assembly		
AACSCB1215	Access Aisle Containment Overhead Basket 150mm Wide - 1200mm Aisle Spacing. Supplied complete with fixings.	Supplied Individually Wrapped
AACSCB1230	Access Aisle Containment Overhead Basket 300mm Wide - 1200mm Aisle Spacing. Supplied complete with fixings.	Supplied Individually Wrapped
AACSCB1815	Access Aisle Containment Overhead Basket 150mm Wide - 1800mm Aisle Spacing. Supplied complete with fixings.	Supplied Individually Wrapped
AACSCB1830	Access Aisle Containment Overhead Basket 300mm Wide - 1800mm Aisle Spacing. Supplied complete with fixings.	Supplied Individually Wrapped

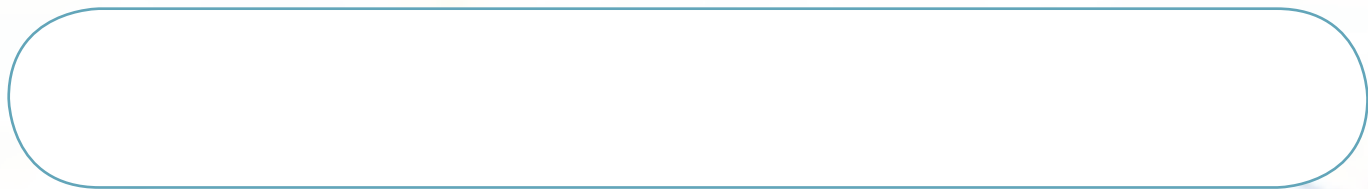

Order Code	Description	Packaging
Aisle Containment Sliding Doors		
AACSSD4212NLCLA	Access Aisle Containment System Double Sliding Doors - To suit 42U height cabinets set configured with a 1200mm wide aisle spacing. Non locking assembly.	Supplied Flat Packed
AACSSD4218NLCLA	Access Aisle Containment System Double Sliding Doors - To suit 42U height cabinets set configured with a 1800mm wide aisle spacing. Non locking assembly.	Supplied Flat Packed
AACSSD4212SLCLA	Access Aisle Containment System Double Sliding Doors - To suit 42U height cabinets set configured with a 1200mm wide aisle spacing. Fitted with Access standard locking swing handle.	Supplied Flat Packed
AACSSD4218SLCLA	Access Aisle Containment System Double Sliding Doors - To suit 42U height cabinets set configured with a 1800mm wide aisle spacing. Fitted with Access standard locking swing handle.	Supplied Flat Packed
AACSSD4212ULCLA	Access Aisle Containment System Double Sliding Doors - To suit 42U height cabinets set configured with a 1200mm wide aisle spacing. Fitted with Access Euro profile uniquely keyed swing handle.	Supplied Flat Packed
AACSSD4218ULCLA	Access Aisle Containment System Double Sliding Doors - To suit 42U height cabinets set configured with a 1800mm wide aisle spacing. Fitted with Access Euro profile uniquely keyed swing handle.	Supplied Flat Packed
AACSSD4212ELCLA	Access Aisle Containment System Double Sliding Doors - To suit 42U height cabinets set configured with a 1200mm wide aisle spacing. Fitted with network monitored electronic proximity locking (needs to be plugged into an i-BOX unit - not included).	Supplied Flat Packed
AACSSD4218ELCLA	Access Aisle Containment System Double Sliding Doors - To suit 42U height cabinets set configured with a 1800mm wide aisle spacing. Fitted with network monitored electronic proximity locking (needs to be plugged into an i-BOX unit - not included).	Supplied Flat Packed
AACSSD4712NLCLA	Access Aisle Containment System Double Sliding Doors - To suit 47U height cabinets set configured with a 1200mm wide aisle spacing. Non locking assembly.	Supplied Flat Packed
AACSSD4718NLCLA	Access Aisle Containment System Double Sliding Doors - To suit 47U height cabinets set configured with a 1800mm wide aisle spacing. Non locking assembly.	Supplied Flat Packed
AACSSD4712SLCLA	Access Aisle Containment System Double Sliding Doors - To suit 47U height cabinets set configured with a 1200mm wide aisle spacing. Fitted with Access standard locking swing handle.	Supplied Flat Packed
AACSSD4718SLCLA	Access Aisle Containment System Double Sliding Doors - To suit 47U height cabinets set configured with a 1800mm wide aisle spacing. Fitted with Access standard locking swing handle.	Supplied Flat Packed
AACSSD4712ULCLA	Access Aisle Containment System Double Sliding Doors - To suit 47U height cabinets set configured with a 1200mm wide aisle spacing. Fitted with Access Euro profile uniquely keyed swing handle.	Supplied Flat Packed
AACSSD4718ULCLA	Access Aisle Containment System Double Sliding Doors - To suit 47U height cabinets set configured with a 1800mm wide aisle spacing. Fitted with Access Euro profile uniquely keyed swing handle.	Supplied Flat Packed
AACSSD4712ELCLA	Access Aisle Containment System Double Sliding Doors - To suit 47U height cabinets set configured with a 1200mm wide aisle spacing. Fitted with network monitored electronic proximity locking (needs to be plugged into an i-BOX unit - not included).	Supplied Flat Packed
AACSSD4718ELCLA	Access Aisle Containment System Double Sliding Doors - To suit 47U height cabinets set configured with a 1800mm wide aisle spacing. Fitted with network monitored electronic proximity locking (needs to be plugged into an i-BOX unit - not included).	Supplied Flat Packed
Fixed Glazed Roof Panel		
AACSRP1203FPCLA	Access Aisle Containment Fixed Perspex Glazed Roof Panel – To suit 1200mm fixed aisle spacing to suit a 300mm wide cabinet unit.	Supplied Flat Packed
AACSRP1206FPCLA	Access Aisle Containment Fixed Perspex Glazed Roof Panel – To suit 1200mm fixed aisle spacing to suit a 600mm wide cabinet unit.	Supplied Flat Packed
AACSRP1208FPCLA	Access Aisle Containment Fixed Perspex Glazed Roof Panel – To suit 1200mm fixed aisle spacing to suit a 800mm wide cabinet unit.	Supplied Flat Packed
AACSRP1209FPCLA	Access Aisle Containment Fixed Perspex Glazed Roof Panel – To suit 1200mm fixed aisle spacing to suit a 900mm wide cabinet unit.	Supplied Flat Packed
AACSRP1803FPCLA	Access Aisle Containment Fixed Perspex Glazed Roof Panel – To suit 1800mm fixed aisle spacing to suit a 300mm wide cabinet unit.	Supplied Flat Packed
AACSRP1806FPCLA	Access Aisle Containment Fixed Perspex Glazed Roof Panel – To suit 1800mm fixed aisle spacing to suit a 600mm wide cabinet unit.	Supplied Flat Packed
AACSRP1808FPCLA	Access Aisle Containment Fixed Perspex Glazed Roof Panel – To suit 1800mm fixed aisle spacing to suit a 800mm wide cabinet unit.	Supplied Flat Packed
AACSRP1809FPCLA	Access Aisle Containment Fixed Perspex Glazed Roof Panel – To suit 1800mm fixed aisle spacing to suit a 900mm wide cabinet unit.	Supplied Flat Packed

Hot Aisle Containment

System Features

Cooper B-Line's i-ACS aisle containment system can be coupled with i-ACE units to provide a room neutral hot aisle containment solution. Ideal for applications where the deployment of additional equipment exceeds the existing data room cooling capacity or where the cooling duty required for a zone of cabinets exceeds the existing computer room air conditioning (CRAC) duty.

The flexibility of the design also allows Cooper B-Line to supply solutions to fit 3rd party racks and enclosures from other equipment manufacturers.

- Standard options to fit 42U & 47U Access Cabinets.
- The standard design allows flexibility of aisle spacing.
- Pod duty can be increased by simply adding additional heat exchangers.
- The risk of single point failures is reduced with the cooling duty of multiple heat exchangers being shared between a number of cabinets.
- Heat exchangers have a 300mm wide foot print.
- Double sliding doors provide easy access without compromising room layouts.
- No trip hazard at the door threshold.
- Choice of aisle door locking options including mechanical and electronic locking.
- Option of fully or partially glazed doors allowing light penetrations as well as unobscured view of the aisle space.
- Fully or partially glazed roof panels allowing light penetration as well as the ability to integrate both fire monitoring and suppression systems.
- Optional sliding roof panels allowing access to areas above the aisle space.
- Aesthetic design that enhances the Access cabinet range.

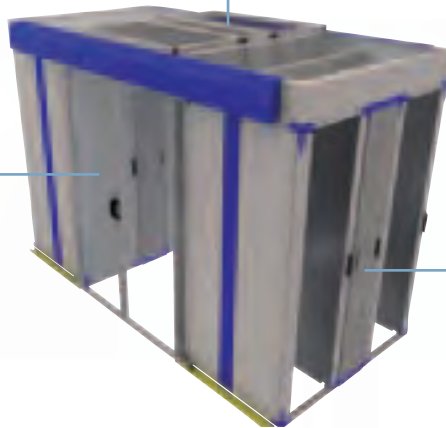

Aisle Containment Component Specification

Doors:

- Aluminium framed mounted onto sliding guide rails.
- Non locking, key locking, mechanical combination and electronic locking options.
- Clear perspex glazed panels for improved light penetration.

Roof Panels:

- Sliding roof panels and adjustable aisle spacing options incorporate aluminium framed roof panels.
- Fixed aisle spacing option utilises a steel framed roof section.
- Clear perspex glazed panels for improved light penetration.

Heat Exchanger Specification & Performance

■ Duty	20kW
■ Airflow rate	1 m ³ /s
■ Delivery air temperature	18°C
■ Return air temperature	35°C
■ Fluid flow rate	1.0 l/s
■ Fluid inlet temperature	10°C
■ Fluid outlet temperature	15°C
■ Weight	175kg (commissioned)

Benefits

- No need to order special cabinets as the system fits to standard Access cabinets.
- Fits both new and existing Access cabinet deployments.
- Wide range of engineered options and accessories.
- Optional installation and commissioning service.
- Modular design allows installations be expanded or ontracted easily.
- Significantly improves cooling efficiencies allowing greater flexibility and the option of cost effectively increasing equipment densities per rack space.

System Operation

The hot aisle containment system works in the same way as a conventional hot aisle / cold aisle layout. Cold air from the local room ambience is drawn through the perforated doors on the front of each cabinet. The cold air is drawn over the active equipment where the heat from the equipment transfers to the air.

The now hot air is expelled either out of the rear or side of the equipment collecting in the rear of the cabinet. At this point it is important that the hot exhaust air is stopped from circulating back to the front of the cabinet as failure to address this issue can lead to the generation of hot spots leading to equipment shut down or premature system failures. Air pressure generated by the internal fans in the active equipment effectively forces the hot air into the hot aisle where it is contained within the hot aisle envelope.

The i-ACE units now come into play. Each i-ACE unit comprises an air / water heat exchanger coil mounted centrally in the unit. Five hot swappable fan units are mounted at the front of the i-ACE unit. These fan units force hot air to be drawn from the hot aisle space through the rear of the i-ACE unit pulling the hot air across the i-ACE's heat exchanger coil. The now cold air is expelled back into the local room environment maintaining the local room ambience at the desired set point.

Each i-ACE unit has a controller built in to the system allowing users to set up the unit locally for optimum operation.

System Layout

With the cabinets configured in a conventional hot aisle / cold aisle layout the hot aisle containment system can be deployed as follows;

- In order to optimise the system cooling efficiency each cabinet needs to be configured with an 80% free area pattern fully vented door at the front and rear. In addition the internal cabinet layout should be baffled to limit the possibility of the hot air exhausted from the active equipment recirculating within the cabinet envelope. Cooper B-Line has a range of shelf tools available to allow any standard Access cabinet to be easily configured to meet this scenario.
- i-ACE 20kW duty 300mm wide heat exchanger units are mounted in series with the cabinets. The width of the unit crucially allows for a single 600mm wide cabinet to be replaced by two standard i-ACE units. The cooling duty per cell (group of cabinets) is configurable according to either the chiller capacity available or the desired cooling capacity for the cell. This solution has the added benefit that each i-ACE unit effectively serves a number of cabinets reducing the worry associated with single point failures.
- The ends of the hot aisle need to be enclosed. Cooper B-Line offer a range of sliding door options as retro fit upgrades compatible with our range of standard Access cabinets. As standard, doors are supplied with Perspex panels fitted to provide a clear view inside the aisle space. Other options include mechanical as well as electronic locks offering the benefit that the cabinet doors on the enclosed hot aisle can be removed, if desired, without compromising cabinet security.
- Roof panels also need to be employed. Again, depending on the end user's preference, panels can be supplied offering both a simple fixed panel option and alternatively a sliding roof option if access is needed to overhead locations above the hot aisle space.

Order Code	Description	Packaging
Hot Aisle Containment Heat Exchangers		
AC421020KWHEHAB	Access Cabinet 42U x 1000mm Deep 20kW Hot Aisle Heat Exchanger Assembly	Crated
AC421220KWHEHAB	Access Cabinet 42U x 1200mm Deep 20kW Hot Aisle Heat Exchanger Assembly	Crated
AC471020KWHEHAB	Access Cabinet 47U x 1000mm Deep 20kW Hot Aisle Heat Exchanger Assembly	Crated
AC471220KWHEHAB	Access Cabinet 47U x 1200mm Deep 20kW Hot Aisle Heat Exchanger Assembly	Crated
Aisle Containment Sliding Doors		
AACSSD4212NLCLB	Access Aisle Containment System Double Sliding Doors - To suit 42U height cabinets set configured with a 1200mm wide aisle spacing. Non locking assembly.	Supplied Flat Packed
AACSSD4218NLCLB	Access Aisle Containment System Double Sliding Doors - To suit 42U height cabinets set configured with a 1800mm wide aisle spacing. Non locking assembly.	Supplied Flat Packed
AACSSD4212SLCLB	Access Aisle Containment System Double Sliding Doors - To suit 42U height cabinets set configured with a 1200mm wide aisle spacing. Fitted with Access standard locking swing handle.	Supplied Flat Packed
AACSSD4218SLCLB	Access Aisle Containment System Double Sliding Doors - To suit 42U height cabinets set configured with a 1800mm wide aisle spacing. Fitted with Access standard locking swing handle.	Supplied Flat Packed
AACSSD4212ULCLB	Access Aisle Containment System Double Sliding Doors - To suit 42U height cabinets set configured with a 1200mm wide aisle spacing. Fitted with Access Euro profile uniquely keyed swing handle.	Supplied Flat Packed
AACSSD4218ULCLB	Access Aisle Containment System Double Sliding Doors - To suit 42U height cabinets set configured with a 1800mm wide aisle spacing. Fitted with Access Euro profile uniquely keyed swing handle.	Supplied Flat Packed
AACSSD4212ELCLB	Access Aisle Containment System Double Sliding Doors - To suit 42U height cabinets set configured with a 1200mm wide aisle spacing. Fitted with network monitored electronic proximity locking (needs to be plugged into an i-BOX unit - not included).	Supplied Flat Packed
AACSSD4218ELCLB	Access Aisle Containment System Double Sliding Doors - To suit 42U height cabinets set configured with a 1800mm wide aisle spacing. Fitted with network monitored electronic proximity locking (needs to be plugged into an i-BOX unit - not included).	Supplied Flat Packed

* Note. Assembly finished black RAL 9005 as standard.

Hot Aisle Containment Cont.

Order Code	Description	Packaging
Aisle Containment Sliding Doors Continued		
AACSSD4712NLCLB	Access Aisle Containment System Double Sliding Doors - To suit 47U height cabinets set configured with a 1200mm wide aisle spacing. Non locking assembly.	Supplied Flat Packed
AACSSD4718NLCLB	Access Aisle Containment System Double Sliding Doors - To suit 47U height cabinets set configured with a 1800mm wide aisle spacing. Non locking assembly.	Supplied Flat Packed
AACSSD4712SLCLB	Access Aisle Containment System Double Sliding Doors - To suit 47U height cabinets set configured with a 1200mm wide aisle spacing. Fitted with Access standard locking swing handle.	Supplied Flat Packed
AACSSD4718SLCLB	Access Aisle Containment System Double Sliding Doors - To suit 47U height cabinets set configured with a 1800mm wide aisle spacing. Fitted with Access standard locking swing handle.	Supplied Flat Packed
AACSSD4712ULCLB	Access Aisle Containment System Double Sliding Doors - To suit 47U height cabinets set configured with a 1200mm wide aisle spacing. Fitted with Access Euro profile uniquely keyed swing handle.	Supplied Flat Packed
AACSSD4718ULCLB	Access Aisle Containment System Double Sliding Doors - To suit 47U height cabinets set configured with a 1800mm wide aisle spacing. Fitted with Access Euro profile uniquely keyed swing handle.	Supplied Flat Packed
AACSSD4712ELCLB	Access Aisle Containment System Double Sliding Doors - To suit 47U height cabinets set configured with a 1200mm wide aisle spacing. Fitted with network monitored electronic proximity locking (needs to be plugged into an i-BOX unit - not included).	Supplied Flat Packed
AACSSD4718ELCLB	Access Aisle Containment System Double Sliding Doors - To suit 47U height cabinets set configured with a 1800mm wide aisle spacing. Fitted with network monitored electronic proximity locking (needs to be plugged into an i-BOX unit - not included).	Supplied Flat Packed
Fixed Glazed Roof Panel		
AACSRP1203FPCLB	Access Aisle Containment Fixed Perspex Glazed Roof Panel - To suit 1200mm fixed aisle spacing to suit a 300mm wide cabinet unit.	Supplied Flat Packed
AACSRP1206FPCLB	Access Aisle Containment Fixed Perspex Glazed Roof Panel - To suit 1200mm fixed aisle spacing to suit a 600mm wide cabinet unit.	Supplied Flat Packed
AACSRP1208FPCLB	Access Aisle Containment Fixed Perspex Glazed Roof Panel - To suit 1200mm fixed aisle spacing to suit a 800mm wide cabinet unit.	Supplied Flat Packed
AACSRP1209FPCLB	Access Aisle Containment Fixed Perspex Glazed Roof Panel - To suit 1200mm fixed aisle spacing to suit a 900mm wide cabinet unit.	Supplied Flat Packed
AACSRP1806FPCLB	Access Aisle Containment Fixed Perspex Glazed Roof Panel - To suit 1800mm fixed aisle spacing to suit a 600mm wide cabinet unit.	Supplied Flat Packed
AACSRP1808FPCLB	Access Aisle Containment Fixed Perspex Glazed Roof Panel - To suit 1800mm fixed aisle spacing to suit a 800mm wide cabinet unit.	Supplied Flat Packed
AACSRP1809FPCLB	Access Aisle Containment Fixed Perspex Glazed Roof Panel - To suit 1800mm fixed aisle spacing to suit a 900mm wide cabinet unit.	Supplied Flat Packed
Sliding Glazed Roof Panel		
AACSRP1206SPCLB	Access Aisle Containment Sliding Perspex Glazed Roof Panel - To suit 1200mm fixed aisle spacing to suit a 600mm wide cabinet unit.	Supplied Flat Packed
AACSRP1208SPCLB	Access Aisle Containment Sliding Perspex Glazed Roof Panel - To suit 1200mm fixed aisle spacing to suit a 800mm wide cabinet unit.	Supplied Flat Packed
AACSRP1209SPCLB	Access Aisle Containment Sliding Perspex Glazed Roof Panel - To suit 1200mm fixed aisle spacing to suit a 900mm wide cabinet unit.	Supplied Flat Packed
AACSRP1806SPCLB	Access Aisle Containment Sliding Perspex Glazed Roof Panel - To suit 1800mm fixed aisle spacing to suit a 600mm wide cabinet unit.	Supplied Flat Packed
AACSRP1808SPCLB	Access Aisle Containment Sliding Perspex Glazed Roof Panel - To suit 1800mm fixed aisle spacing to suit a 800mm wide cabinet unit.	Supplied Flat Packed
AACSRP1809SPCLB	Access Aisle Containment Sliding Perspex Glazed Roof Panel - To suit 1800mm fixed aisle spacing to suit a 900mm wide cabinet unit.	Supplied Flat Packed

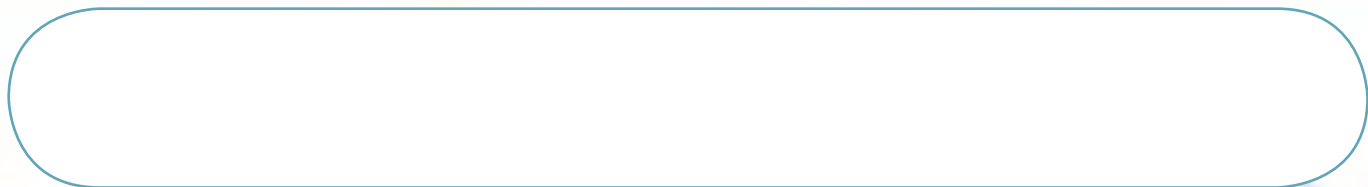

Order Code	Description	Packaging
Adjustable Aisle Glazed Roof Panel		
AACSRP1203AFCLB	Access Aisle Containment Adjustable Perspex Glazed Roof Panel – To suit an aisle spacing from 1000mm – 1200mm and to suit a 300mm wide cabinet unit.	Supplied Flat Packed
AACSRP1206AFCLB	Access Aisle Containment Adjustable Perspex Glazed Roof Panel – To suit an aisle spacing from 1000mm – 1200mm and to suit a 600mm wide cabinet unit.	Supplied Flat Packed
AACSRP1208AFCLB	Access Aisle Containment Adjustable Perspex Glazed Roof Panel – To suit an aisle spacing from 1000mm – 1200mm and to suit a 800mm wide cabinet unit.	Supplied Flat Packed
AACSRP1209AFCLB	Access Aisle Containment Adjustable Perspex Glazed Roof Panel – To suit an aisle spacing from 1000mm – 1200mm and to suit a 900mm wide cabinet unit.	Supplied Flat Packed
AACSRP1803AFCLB	Access Aisle Containment Adjustable Perspex Glazed Roof Panel – To suit an aisle spacing from 1600mm – 1800mm and to suit a 300mm wide cabinet unit.	Supplied Flat Packed
AACSRP1806AFCLB	Access Aisle Containment Adjustable Perspex Glazed Roof Panel – To suit an aisle spacing from 1600mm – 1800mm and to suit a 600mm wide cabinet unit.	Supplied Flat Packed
Adjustable Aisle Glazed Roof		
AACSRP1808AFCLB	Access Aisle Containment Adjustable Perspex Glazed Roof Panel – To suit an aisle spacing from 1600mm – 1800mm and to suit a 800mm wide cabinet unit.	Supplied Flat Packed
AACSRP1809AFCLB	Access Aisle Containment Adjustable Perspex Glazed Roof Panel – To suit an aisle spacing from 1600mm – 1800mm and to suit a 900mm wide cabinet unit.	Supplied Flat Packed
Cable Channel Top Panel Assembly		
AACSCC03STB	Access Aisle Containment System – 300mm Wide Standard Cable Channel	Supplied Individually Wrapped
AACSCC06STB	Access Aisle Containment System – 600mm Wide Standard Cable Channel with Brush Strip Entry	Supplied Individually Wrapped
AACSCC08STB	Access Aisle Containment System – 800mm Wide Standard Cable Channel with Brush Strip Entry	Supplied Individually Wrapped
AACSCC09STB	Access Aisle Containment System – 900mm Wide Standard Cable Channel with Brush Strip Entry	Supplied Individually Wrapped
Overhead Cable Basket Assembly		
AACSCB1215	Access Aisle Containment Overhead Basket 150mm Wide - 1200mm Aisle Spacing. Supplied complete with fixings.	Supplied Individually Wrapped
AACSCB1230	Access Aisle Containment Overhead Basket 300mm Wide - 1200mm Aisle Spacing. Supplied complete with fixings.	Supplied Individually Wrapped
AACSCB1815	Access Aisle Containment Overhead Basket 150mm Wide - 1800mm Aisle Spacing. Supplied complete with fixings.	Supplied Individually Wrapped
AACSCB1830	Access Aisle Containment Overhead Basket 300mm Wide - 1800mm Aisle Spacing. Supplied complete with fixings.	Supplied Individually Wrapped

* Note. Assembly finished black RAL 9005 as standard.

Configure Your Own Cabinet

Configurations

On the preceding pages you will have seen a host of common configurations but the options do not stop there! The flexibility of the Access Cabinet range coupled with its modular approach provides end users with the opportunity to configure a cabinet to an exacting specification. The following pages are intended to show how to create a part code for even the most detailed cabinet using the Access Cabinet dynamic part code system. In addition, these pages will also explain how individual component and assembly codes are developed to aid users understanding of the product range.

If you still can not find what you need then please contact us and we will be pleased to discuss your requirements further. With over 50 years of experience in supplying technical enclosure solutions we have learnt that what is a new requirement today usually becomes the standard requirement of tomorrow.

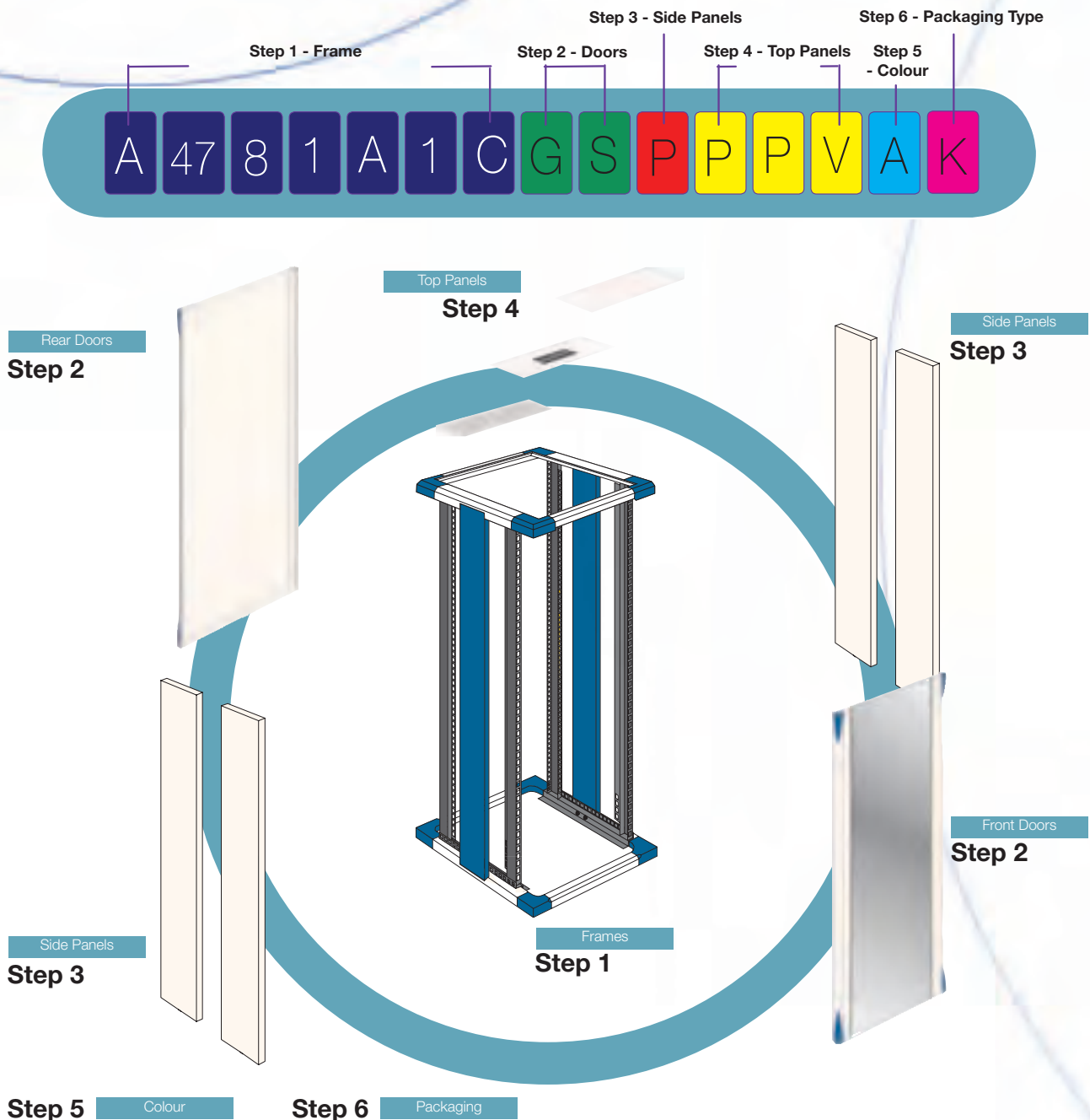

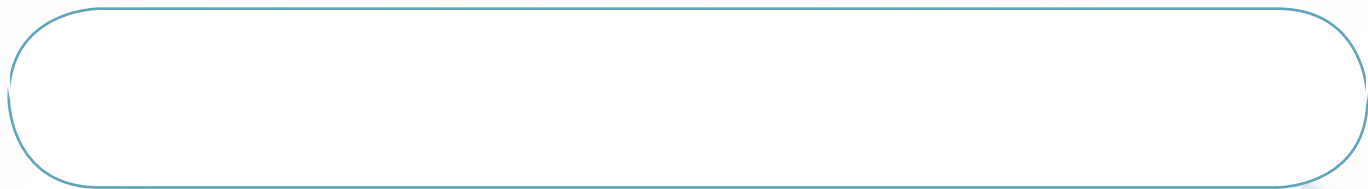

A	Access	
47	Unit Height	Stock Sizes - 22U, 27U, 39U, 42U, 47U Non Stocked Sizes - 12U, 17U, 32U, 45U, 52U Custom Sizes Available Upon Request
8	Unit Width	6 = 600mm 7* = 700mm 8 = 800mm
1	Unit Depth	6 = 675mm 1 = 1000mm 8 = 875mm 2 = 1200mm 9 = 915mm 4* = 1400mm
A	Frame Style	A = Standard Corner Plates + Jacking Feet P = With Standard Plinth Kit + Jacking Feet O = Standard Plinth + Castors C = Frame On Nylon Skids Q = With Standard Plinth Kit + Jacking Feet + Castors U = Universal Corner Plates + Jacking Feet G = Standard Corner Plates + Castors L = With Stabilising Plinth + Jacking Feet S = Standard Corner Plates + Short Skids H = Universal Corner Plates + Jacking Feet + Castors M = With Stabilising Plinth + Jacking Feet + Castors
1	Rail Type	1 = 19-inch (x4) 6 = 19-inch (x2) 2 = 23-inch (x4) 7 = ETSI (x4) 5 = Full Width (x4) 8 = 19-Inch with RCM+ Fingers (x4)
C	Rail Position	L = Offset Left C = Centre R = Offset Right
G	Front Door Option	A = Acrylic Glazed Door – LH Hinged P = Glazed Door (Non Vented Styles) – RH Hinged B = Acrylic Glazed Door – RH Hinged Q = Pressurised Rear Door – LH Hinged C = Access Cover Trims R = Pressurised Rear Door – RH Hinged G = Glazed Door (Vented Styles) – LH Hinged S = Plain Steel Door – LH Hinged H = Glazed Door (Vented Styles) – RH Hinged T = Plain Steel Door – RH Hinged I = High Flow Server Door With Metal Trims – LH Hinged V = Vented Steel Door – LH Hinged J = High Flow Server Door With Metal Trims – RH Hinged W = Vented Steel Door – RH Hinged L = Wardrobe Style Double Glazed Doors – LH Hinged Y = Wardrobe Style Double Plain Steel Doors N = No Doors Z = Wardrobe Style Double Vented Steel Doors O = Glazed Door (Non Vented Styles) – LH Hinged
S	Rear Door Option	
P	Side Panel Option	P = Plain Both Sides E* = Vented Left Side Only N = No Panels Both Sides L = Plain Left Side Only F* = Vented Right Side Only R = Plain Right Side Only V* = Vented Both Sides
P	Top Panel Zone 1 Option	B = Brush Strip C = Brush Strip Infill E = Vented Brush Strip N = No Panel P = Plain V = Vented X = Plain Infill
P	Top Panel Zone 2 Option	2 = 2-Way Fan Tray (110v A/C) 3 = 3-Way Fan Tray (110v A/C) 4 = 2-Way Fan Tray (230v A/C) 5 = 2-Way Fan Tray + Controller 6 = 3-Way Fan Tray (230v A/C)
V	Top Panel Zone 3 Option	
A	Colour Scheme	A = Light Grey + Blue Trim B = Black + Black Trim C = Light Grey + Black Trim D = Black + Blue Trim G = Light Grey + Mid Grey Trim
K	Packaging Type	No Character = Assembled and Palletised B = Cabinet Components Bulk Packed For Local Assembly K = Each Cabinet Individually Flat Packed

Items marked * are either held as limited stock or made to order. Please contact our customer services team for availability.

Step 1 - Frame Configuration

Access, “the original cornerless cabinet”, has been developed and enhanced with the goal of providing the ultimate 19-inch cabinet solution. Focused on the demands and expectations of a global market driven by technology, Access continues to evolve to meet the new demands and aspirations of the market thanks to the concept of its modular approach.

Performing a key role, the cabinet is an essential consideration when deploying an infrastructure solution, as the equipment housed in the cabinet is often Mission Critical and consequently key to the success of the business. Designed from the frame up the Access Cabinet System has evolved with application excellence and user friendliness in mind.

Based on a cantilever frame concept the base structure comprises tubular frames top and bottom connected by central extrusions. This design allows unhindered 180 degree clearance around the front and rear mounting angles whilst at the same time offering clear access to the internal cabinet envelope. This crucially allows installation and maintenance to be carried out in a far more efficient manner and ultimately provides the tool to reduce the total cost of ownership during the lifetime of the cabinet.

The wide range of cabinet sizes offered provides the ability to construct a diverse range of internal configurations, allowing both existing and next generation network components to be housed, irrespective of their mounting requirements. As a consequence, Access is equally at home housing 19-inch (EIA-310D compliant), ETSI (European Telecommunications Standards Institute) or non rack-mounted units and can be configured to offer combinations of mounting technologies in one single cabinet structure.

For installations requiring multiple cabinets bayed or ganged together, Access enables cabinets to be securely fastened together by simply bolting the matting central extrusions together using the pre drilled bolt together holes.

In the same way that the internal cabinet arrangement can be configured, the external cabinet cladding can be specified to meet individual application requirements. Cladding options include top panels, base panels, side panels and door options with each of these explained in more detail on the following pages.

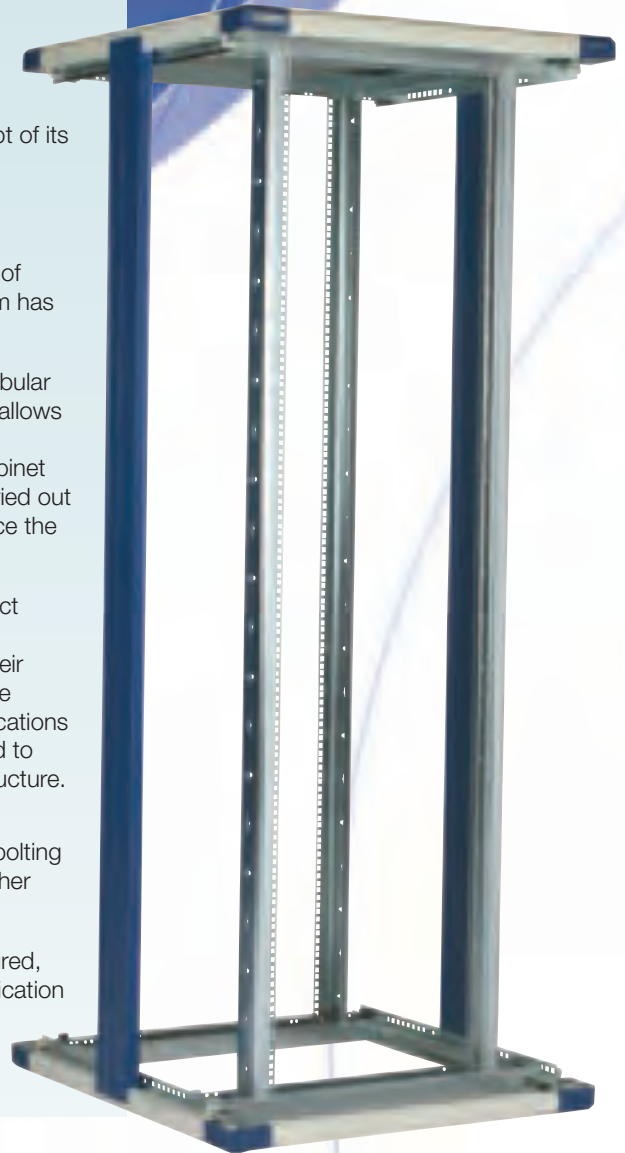

Front to rear
adjustment
600mm wide models



Lateral adjustment on
800 wide models



Front to rear
adjustment
800mm wide models

Step 1 - Frame Configuration

Component Part
Number Only

Step 1 - Frame

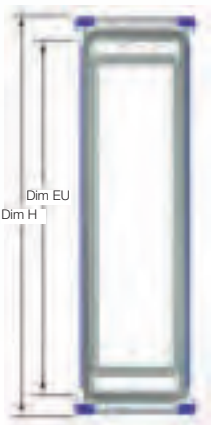

Frame Effective Height

Std Cabinet Heights	Effective Height	Dim EU (mm)	Dim H (mm)	Frame + Castors (mm)	Frame + Std Plinth (mm)
12*	12U	534.7	667	754	770
17*	17U	757.0	899	976	992
22	22U	979.2	1112	1199	1215
27	27U	1201.5	1334	1421	1437
32	32U	1423.7	1557	1644	1660
39	39U	1734.9	1867	1954	1970
42	42U	1868.2	2000	2087	2103
47	47U	2090.5	2223	2310	2326

* Dim H denoted frame fitted on standard Nylon skids



Frame Width

Std Cabinet Width	Dim W (mm)	19-Inch compatible	23-Inch Compatible	Full Width Compatible
6	600	✓	X	X
7	700	✓	✓	X
8	800	✓	✓	✓

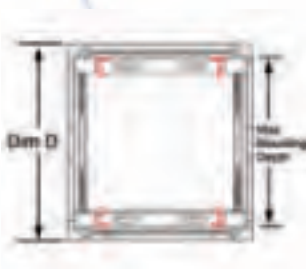

Frame Depth

Std Cabinet Depth	Dim W (mm)	Std. Rail Centres	Maximum Rail Centres
6	675	419	570
8	875	619	770
9*	915	659	810
1	1000	744	895
2*	1200	944	1095
4*	1400	1144	1295

Step 1 - Frame Configuration Cont.

Frame Style

Frame Config.	Frame	Skids	Std. Plinth	Stabilising Plinth	Std Corner Plate	Universal Corner Plate	Jacking Feet	Castors
A	✓				✓		✓	
C	✓	✓						
G	✓				✓			✓
H	✓					✓	✓	✓
P	✓		✓				✓	
Q	✓		✓				✓	✓
L	✓			✓			✓	
M	✓			✓			✓	✓
O	✓		✓					✓
U	✓						✓	
S	✓	✓			✓			

Mounting Rail Configuration

Rail Code	Description	Qty. Rails	Frame Capacity.		
			600w	700w	800w
1	Standard rails set at 19-inch centres	4	✓	✓	✓
2	Standard rails set at 23-inch centres	4	x	x	✓
5	Standard rails set at full width	4	x	x	✓
6	Standard rails set at 19-inch centres	2	✓	✓	✓
7	European Telecom Standards Institute (ETSI) rails	4	✓	✓	✓
8	Standard rails set at 19-inch centres with RCM+ fingers	4	✓	✓	✓

Mounting Rail Positioning

Description	Left Offset	Right Offset	Offset Centre
	L	R	C
Access 600mm wide frame	X	X	✓
Access 700mm wide frame	✓	✓	✓
Access 800mm wide frame	✓	✓	✓



Step 2 - Door Configuration

The Access Cabinet is available with a wide variety of front and rear door options, all utilising two point locking and quick release hinges for easy door removal. As with the side panels doors can only be removed once access has been gained to the inside of the cabinet. The locking system of each door is actuated via a single swing handle assembly. Various types of swing handles are available enabling factory or user configurable locking methods including;

- Universal key locking swing handles (standard)
- Individually keyed swing handles (front and rear doors operated by the same unique key)
- Individually keyed swing handles with a master key (front and rear doors operated by the same unique key with the addition of a master key to operate a batch of locks)
- Stand alone electronic proximity card locking swing handles – i-PAL (customer configurable up to 500 users per handle)
- Networked electronic proximity card locking swing handles – i-PAL+ with remote override and monitoring (customer configurable up to 4,000 users per handle).

Each door option is configurable as either a left hand or right hand hinged variant and is available in plain steel, vented glazed, plain glazed, acrylic glazed, fully vented and high flow vented. Additionally most door options are available in a double wardrobe door format ideal for applications where full width doors cannot be accommodated due to space restraints.

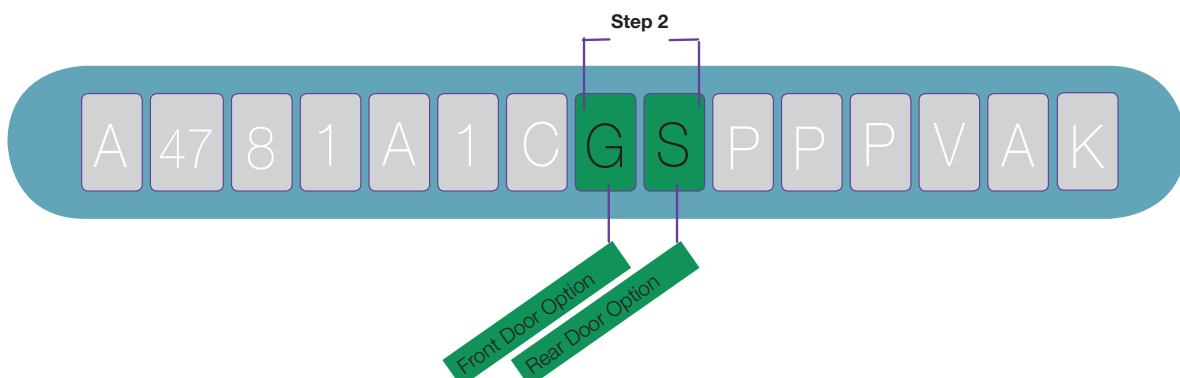

Step 2 - Door Configuration Cont.

Door Configurations

Door Configuration	Door Description	Door Configuration	Door Description
A	Acrylic Glazed Door – LH Hinged	O	Glazed Door (Non Vented Styles) – LH Hinged
B	Acrylic Glazed Door – LH Hinged	P	Glazed Door (Non Vented Styles) – LH Hinged
C	Cover Trims	Q	Pressurised Rear Door – LH Hinged
G	Glazed Door (Vented Styles) – LH Hinged	R	Pressurised Rear Door – RH Hinged
H	Glazed Door (Vented Styles) – LH Hinged	S	Plain Steel Door – LH Hinged
I	High Flow Server Door With Steel Trims – LH Hinged	T	Plain Steel Door – RH Hinged
J	High Flow Server Door With Steel Trims – LH Hinged	V	Vented Steel Door – LH Hinged
L	Wardrobe Style Double Glazed Doors.	W	Vented Steel Door – RH Hinged
N	No Door	Y	Wardrobe Style Double Plain Steel Doors
		Z	Wardrobe Style Double Vented Steel Doors

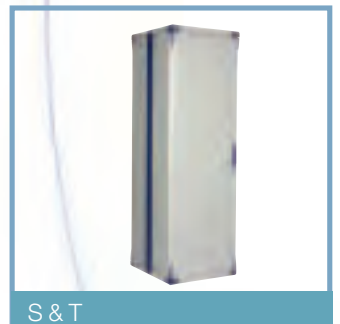
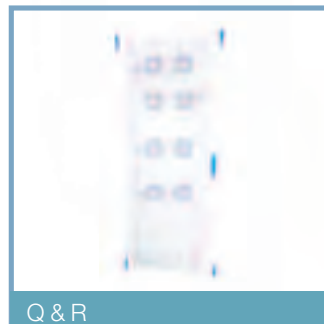
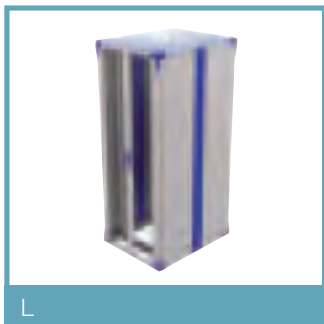
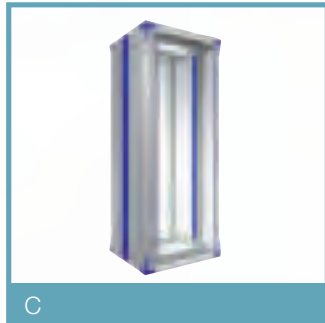
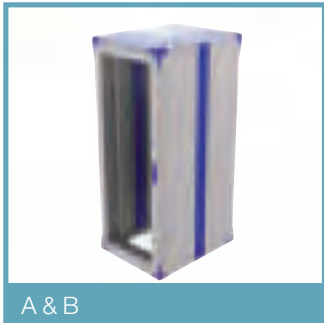

Step 3 - Side Panel Configuration

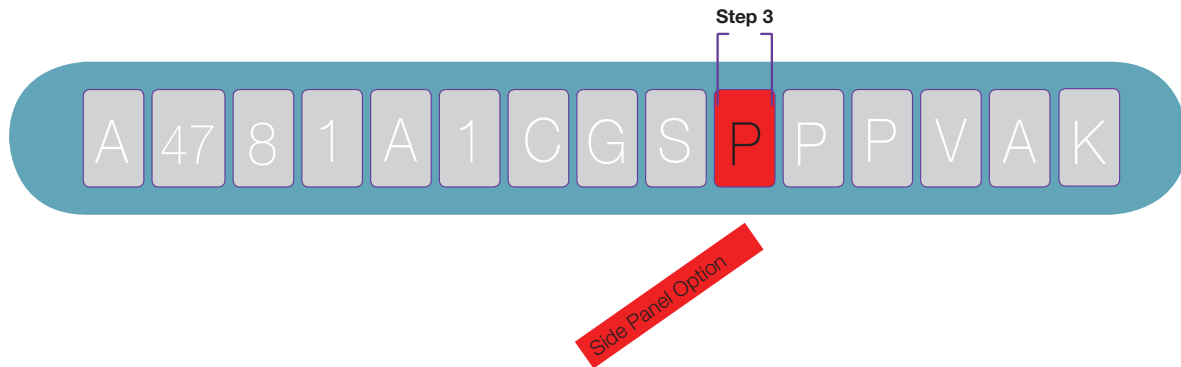

Side Panel Configuration

Side Panel Configuration	Option Description
P	Plain Side Panels Fitted Both Sides
L	Plain Side Panels Fitted LH Side Only
R	Plain Side Panels Fitted RH Side Only
E*	Vented Side Panels Fitted LH Side Only
F*	Vented Side Panels Fitted RH Side Only
V*	Vented Side Panels Fitted Both Sides
N	No Side Panels Fitted

* Vented side panels are only available as standard in 42U and 47U heights and in 875mm, 1000mm, 1200mm depth variants.



Plain Side Panel



Vented Side Panel

Each cabinet side can be fitted with two half-depth side panels filling the aperture between the central extrusion and the front door aperture. The panels are depth specific and being narrower than half the cabinet depth makes it far easier to handle should they need to be completely removed.

Each panel is fitted with four quick release hinge pins allowing quick and easy removal of individual panels in a matter of seconds. This feature eliminates the need to completely remove individual side panels, as they can be simply swung open to provide access to the internal cabinet envelope and helps to eliminate the chances of side panels getting damaged or lost.

Importantly the quick release hinge pins can only be actuated once access has been gained inside the cabinet with access into the cabinet being controlled via the front and rear locking doors.

Side panels are available in plain format for all cabinet sizes and in vented format for a range of specific unit configurations.



Step 4 - Top Panel Configuration

The top frame aperture on each Access cabinet offers the opportunity to configure the top panel arrangement to meet the needs of individual applications. The dynamic part code matrix makes provision to specify the panel layout in three zones, front, middle and rear.

The depth of the cabinet impacts the quantity and type of panels that can be utilised. Details of these layouts are shown in the table below. In instances where the dynamic part code can no longer relate to individual panels (for instance where the 1200mm and 1400mm deep cabinets have more than three panels in the top) the first numeral relates to the panel mounted at the front of the cabinet and the third numeral relates to the panel fitted in the rear of the cabinet. The second numeral then defines the centre zone layout with the defined panel being mounted at the rear of the zone and the remaining aperture filled with plain panels.

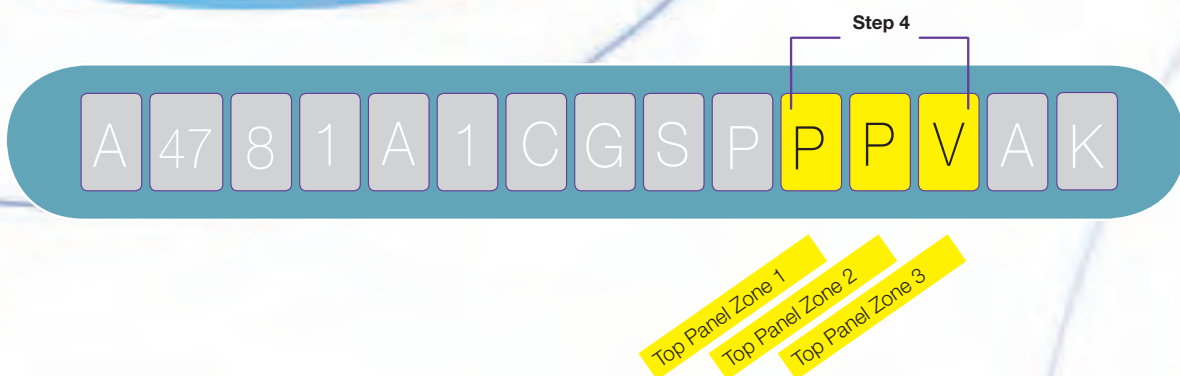

Top Panel Configuration

Top Panel Configuration	Option Description	Top Panel Configuration	Option Description
B	Brush Strip Entry Panel	X	Plain Infill Panel
C	Brush Strip Infill Panel	2	2-Way Fan Tray (110v A/C)
E	Vented Brush Strip Panel	3	3-Way Fan Tray (110v A/C)
N	No Panel	4	2-Way Fan Tray (230v A/C)
P	Plain Panel	5	2-Way Fan Tray + TCM1000 Controller
V	Vented Panel	6	3-Way Fan Tray (230v A/C)



Cabinet Depth (mm)	Total Panels	Standard Panel	Infill Panels Required
675mm	2	2	0
875mm	3	2	1
915mm	3	2	1
1000mm	3	3	0
1200mm	4	3	1
1400mm	4	3	1

Step 5 - Colour



The Access cabinet is available in a range of standard colour options as shown below.

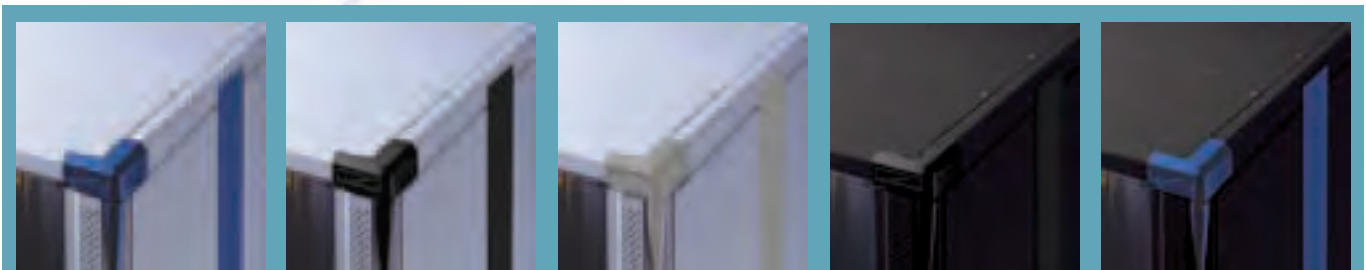

The unique and stylish corner moulding of the Access range provides an easy system for individual branding or cabinet identification. Silk screening on glass doors is also available.

Standard Trim Colour Options

- Blue - NCS 4550-R90B
- Black - RAL 9005
- Mid Grey - NCS 4502

Standard Panel Colour Options

- Light Grey - NCS 1502-Y
- Black - RAL 9005
- Custom colour options are available subject to a single delivery quantity of a minimum of 10 units. Colour requirements must be specified against a standard colour system, e.g. RAL colour scheme.

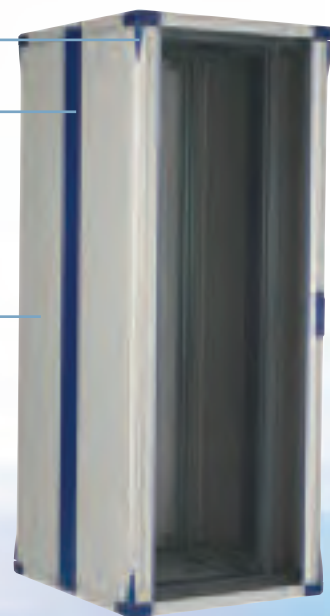

Other colour and finish options including Low Smoke Zero Halogen (LS0H) finish are available to order, please contact our customer services department to discuss your specific requirements.

Step 6 - Packaging Options



Step 5

Packaging Type

Packaging Options
 No Character = Assembled & Palletised
 B = Bulk Packed
 C = Flat Packed & Crated
 K = Flat Packed

The Access cabinet is available in a range of packaging options to meet the demands of end users and channel partners. Standard packaging options include the following;

No Character	Assembled & Palletised
B	Bulk Packed
C	Flat Packed & Crated
K	Flat Packed



Specifying & Ordering Component Assemblies

In some cases it may be advantageous to order cabinets in component parts rather than a top level single configured part.

The following pages provide an overview of the part code matrixes applicable together with an overview of the options available. Following a similar layout as that previously outlined for the configured cabinets, the following pages will look at assemblies in the following order;

- Configuring cabinets for Thermal Loads
- Cabinet frame, including;
 - Base mounting options
 - Mounting angle types and configurations
 - Packaging types
 - Mounting rail options
- Base panel options
- Computer floor plinth options
- Top panel options
- Door options (doors are universal and can be fitted at the front or rear)
- Side panel options
- Vertical cable management options
- Horizontal cable management options
- Universal cable management options
- In rack cooling options
- Cabinet thermal enhancements
- Shelving options
- Power distribution options
- In rack fire suppression
- Access control and environmental monitoring solutions

Configuring A Cabinet For Thermal Loads



5 x 7U Blade Boxes
 $\Sigma 15KW$



5 x 7U Blade Boxes
 $\Sigma 15KW$

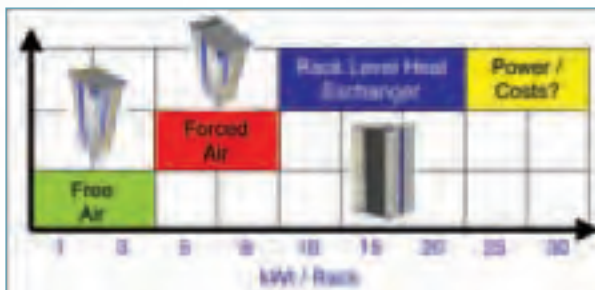

Access Cabinet Thermal Management Overview

In today's environment cabinet heat loads not only differ from site to site but also from cabinet to cabinet. No two cabinet installations have either the same equipment layouts or environmental and heat load characteristics. Indeed, by design, the equipment heat load characteristics change according to process demands and, by default, often change the characteristics of the local environment.

Whilst the "one solution fits all" approach can provide a thermally capable result, the drive to minimise power consumption by maximising efficiency can, in the long term, prove that this is the wrong choice from both a financial and environmental standpoint. How you efficiently and effectively manage the heat load within individual cabinets is therefore dependant on the available services at the individual cabinet location. In broad terms any cabinet in a data room environment can be classified into one of three categories as described below.

1. Localised Single Cabinet Environments.

Typically this scenario can be found in smaller network installations that have evolved over a period of time. Because the internal cabinet environment relies on local ambient air to provide cooling capacity, other localised influences can impact on the cabinet's cooling efficiency. These issues can range from adversely positioned hot air exhausts from other cabinets, through to the remote location of the cabinet in relation to the computer room air conditioning (CRAC) unit.

2. Hot & Cold Aisle Installation.

Typically found within most larger scale data centres this design usually utilises a pressurised floor layout where the cold air from the CRAC unit is fed into the under floor void. The cold air is guided over / through the active equipment before being exhausted as hot air at the rear of the cabinet. In this type of scenario cold air is fed down one aisle and hot air is returned down another aisle. Issues can still arise from this situation as installations evolve and change over time.

3. High-Density Applications.

The drive by network owners to maximise revenues together with the advent of new technologies has seen thermal loads within both cabinet structures and room environments exceeding previous design limitations. As a consequence customers are looking for practical solutions designed to overcome these limitations and to provide the ability to maximise data room layouts.

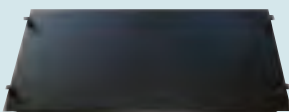

fig. 1

Hot And Cold Air Crossover



Hot And Cold Air Segregation



19-inch Quick Fit Blanking Panels



Vented Steel Doors

Modular Solutions For Global Concerns

Cooper B-Line has developed a range of modular components that enable users to configure the Access Cabinet range to manage a variety of heat load applications. To help to simplify the configuration process the colours in the associated boxes below are used on the preceding pages to help to identify the modular component that can or should be used to configure the cabinet to deal with the applicable heat load.

In all cases the developed solution relies on the implementation of “best practices” enabling users to optimise systems in the most efficient way. One of the basic requirements for providing efficient cabinet cooling is the ability to stop hot air / cold air cross over. Fig. 1 shows the impact of failing to address this issue resulting in the hot air expelled by the active equipment simply recirculating inside the cabinet structure. This scenario can ultimately lead to extreme hot spots, which in turn can cause premature equipment failure.

Modular Components

The following is an overview of a range of components that provide the tools to optimise cabinet layouts to provide individually tailored thermal solutions.

Side Panels.

In order to achieve optimum cooling efficiencies, the airflow within a cabinet structure needs to be governed to avoid hot air recirculating and adversely affecting other cabinets or equipment. In order to create a known envelope solid side panels should be fitted to both sides of the cabinet structure.

Vertical Brush Strip Baffle Panels.

Available to suit both 600mm, 700mm and 800mm wide Access Cabinets these vertical brush strip baffles stop hot air recirculating around to the front of the cabinet by filling in the aperture between the mounting angle and the side panel.

For normal server applications these baffles would be fitted either side of the front 19-inch mounting angles. Where mixed technologies (servers and switches) need to be housed the baffles can be staggered creating two “L” shaped voids. Typically a baffle would be fitted on the front left hand side providing a cold air void along the front and right hand side of the cabinet. The hot air void would then comprise of the opposing “L” shaped void down the left hand side and rear of the cabinet.

19-inch Quick Fit Blanking Panels.

To optimise the flow of cold air any unused 19-inch mounting apertures should be blanked off. By doing this you not only ensure that the cold air only goes where you want it, you also stop hot air / cold air cross over, avoiding the possibility of hot air recirculating around to the front of the cabinet. Cooper B-Line have developed a range of tool-less fixing panels to ease this process and make changes and updates quicker.

Vented Steel Doors.

In applications where the cold air needs to be drawn through the front door and expelled through the rear door it is advisable that a vented door with a free area rating of 55%+ is used. It should be noted that up to 63% free area the cooling efficiency improves, linearly. Beyond 63% free area the efficiency gain is negligible, however we can offer an 84% door to fully maximise the cooling potential.

The vented door allows sufficient air to enter the cabinet and for the equipment fans to operate efficiently. The equipment fans create a positive pressure in the rear of the cabinet helping to force the hot air out of the cabinet.

Configuring A Cabinet For Thermal Loads Cont.

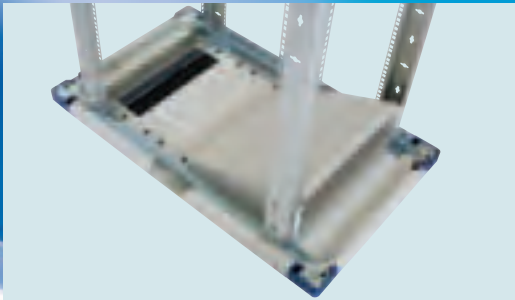

Base Panel Blanking Options



Roof Mounted Fan Trays



Rack Mounted Fan Trays

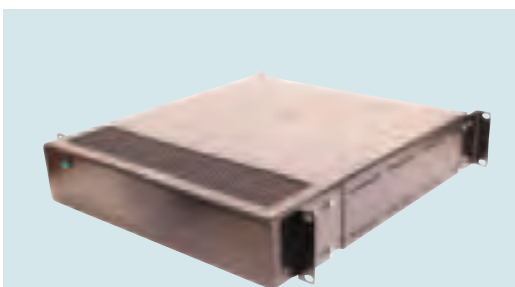

Scavenger Fan Tray

Modular Components

Glazed or Solid Steel Doors.

For installations where it is possible to duct air into the front of the cabinet it may be preferable for a solid or glazed door be fitted to the front of the cabinet. With this design a void is created by the side panels, the inside of the front door and the closed face of the 19-inch mounting angles. This structure creates a chimney effect for the cold air feed providing optimum operation.

Base Panel Blanking Options.

Where pressurised floors are employed the drive should be to maintain as high a pressure under the floor as possible. To achieve this, consideration should be given to closing off any partial or redundant apertures including ensuring that cable apertures are sealed off where practical.

Cooper B-Line has developed a range of blanking panels to be used with its computer floor plinth solution. In addition, where plinths are not required, a range of cabinet base blanking plates are also available offering a modular solution to match most applications or installations.

Roof Mounted Fan Trays.

In some applications it may be beneficial to exhaust hot air out of the top of the cabinet. In such instances the Access Cabinet can be fitted with a range of retrofit fan tray solutions catering for both server and / or switch applications.

Rack Mounted Fan Trays.

For applications where you need to boost the air flow within a cabinet area these rack mounted 1U fan trays can be fitted at either the front or the rear of the cabinet.

Available as standard in three fan or six fan configurations, these fans trays are also available with a TCM1000 fan controller integrated into the unit to provide both fan speed control and fan failure alarm.

Scavenger Fan Tray.

Developed to mount into the bottom 2U of the cabinet the scavenger fan tray has been designed to pull air from either the floor void or from the local ambient environment. The unit has been developed to create a cold air chimney and is used to generate a pressurised air feed to the area in front of the 19-inch mounting channels.

Ideal for scenarios where the air flow to the cabinet is restricted due to the remote location of the cabinet in relation to the CRAC unit. In such cases the scavenger unit is capable of replicating the air feed characteristics of a cabinet located in close proximity to the CRAC unit.

Modular Components (cont.)

Quick Fit Server & Switch Side Blanking Panels.

New from Cooper B-Line comes a range of both fixed and adjustable depth side blanking plates. Supplied with tool-less fixings they are available in a range of unit heights allowing quick and easy configuration. Essential for applications where mixed technologies such as servers and switches are employed in the same cabinet, these blanking plates allow apertures to be created to manage optimum airflow paths.

Pressurised Vented Door.

Cooper B-Line has developed a pressurised vented door solution that provides the user with the ability to optimise hot air removal from within the cabinet structure. The design allows the customer to configure the assembly to deal with hot-spot scenarios. Thanks to its modular design the user can easily and quickly configure the door to match the layout of the active equipment even when the configuration changes.

High Density Cabinet Cooling.

Historically data centres have been designed to cope with thermal loads of between 1.5KW to 4.0KW per square metre. Nowadays with the advent of newer technologies including both Pizza Box Servers and Blade Servers, users are aiming to configure cabinets with thermal loads in the range of 20KW.

It is true to say that users can generate configurations that produce heat loads in excess of 20KW. However the drive by equipment manufacturers to improve equipment efficiencies, ever increasing power costs and greater awareness of the "Green" issues, are seeing these types of configurations being engineered out.

Whilst physically 15 – 17KW heat loads can be accommodated in the cabinet structure, it is often the case that the data room infrastructure is unable to cope with these demands given that they must also service the other cabinets in the local environment. In such cases it is often far cheaper and less disruptive to implement ancillary cooling systems to cope with localised heat loads. In response to these demands Cooper B-Line have developed a High Density retrofit heat exchanger unit that can be mounted to the side of an Access Cabinet system. The heat exchanger can be mounted to the left or right hand side of the cabinet, an option to mount two units configured to service one cabinet offers a N+1 (100% redundancy) capability.

Using water as the cooling medium the unit utilises existing proven technologies, with the added benefit of ensuring that the cooling medium is located outside the main cabinet structure avoiding the concerns often voiced with either rack mounted or overhead mounted heat exchanger systems.

Thermal Analysis Using Computational Fluid Dynamics (CFD)

As part of Cooper B-Line's thermal solution package we are able to validate solutions prior to their implementation by employing leading edge computational fluid dynamics (CFD) packages to accurately predict real time scenarios. This importantly allows Cooper B-Line to ascend to the next level of productivity by enabling these aspects to be accurately considered and addressed during the rack design process.

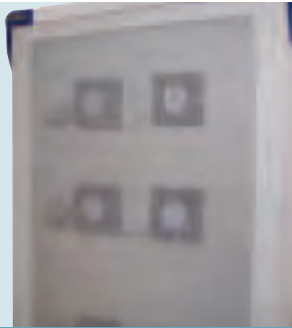

Pressurised Vented Door



High Density Cabinet Cooling

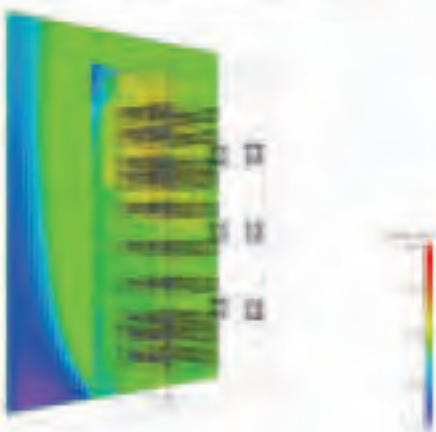

Thermal Analysis Using Computational Fluid Dynamics (CFD)

Component Assembly Specification & Order Codes

Frame Only Assemblies

Frame Only Assembly

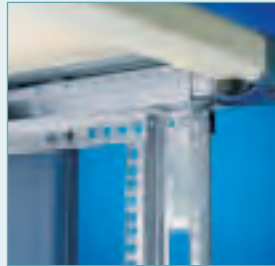
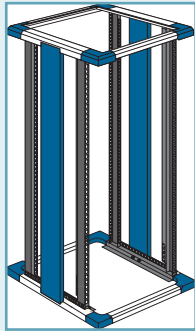

Front to rear adjustment
600mm wide models



Lateral adjustment on
800 wide models



Front to rear adjustment
800mm wide models

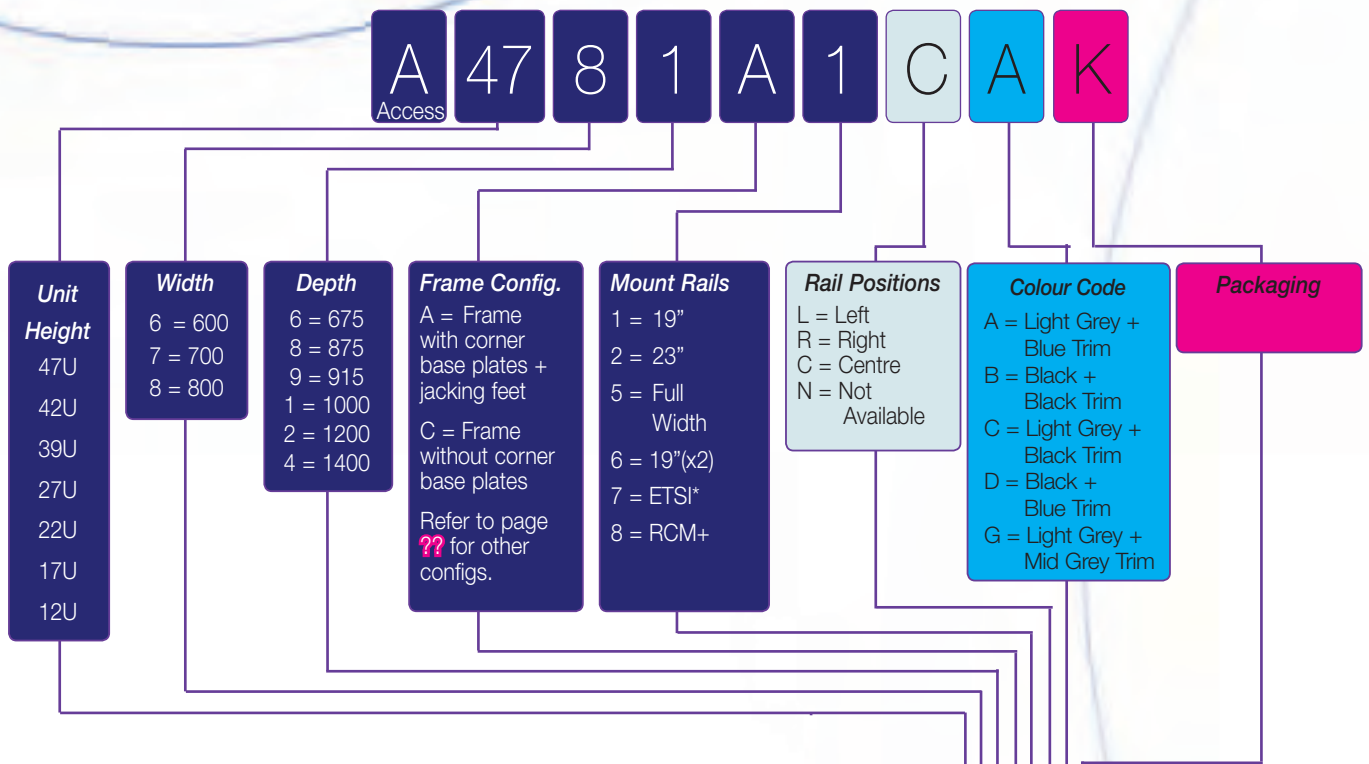

Effective Unit Height	Overall Frame Height (mm)	Width (mm)	Depth (mm)	Order Code See Legend Above to Complete Part Number	Shipping Weight (kg)
12U	668*	600	675	A 12 6 6 X X C X	20.5
			875	A 12 6 8 X X C X	24.5
22U	1112*	600	675	A 22 6 6 X X C X	37.6
			875	A 22 6 8 X X C X	45.0
			675	A 22 8 6 X X C X	51.8
			875	A 22 8 8 X X C X	58.5

Sample Code - A2266C1CA

X- Denotes Option.

Effective Unit Height	Overall Frame Height (mm)	Width (mm)	Depth (mm)	Order Code	Shipping Weight (kg)
				See Legend Above to Complete Part Number	
27U	1334*	600	675	A 27 6 6 X X C X	42.6
			875	A 27 6 8 X X C X	50.0
			915	A 27 6 9 X X C X	52.0
			1000	A 27 6 1 X X C X	62.5
		800	675	A 47 8 6 ■■■■	76.2
			875	A 47 8 8 ■■■■	83.5
			915	A 47 8 9 ■■■■	86.2
			1000*	A 47 8 1 ■■■■	96.1
32U	1557*	600	675	A 32 6 6 X X C X	47.6
			875	A 32 6 8 X X C X	55.0
			915	A 32 6 9 X X C X	57.6
			1000	A 32 6 1 X X C X	67.5
		800	675	A 32 8 6 X X C X	61.8
			875	A 32 8 8 X X C X	68.5
			915	A 32 8 9 X X C X	71.2
			1000	A 32 8 1 X X C X	91.1
39U	1867*	600	675	A 39 6 6 X X C X	54.6
			875	A 39 6 8 X X C X	62.0
			915	A 39 6 9 X X C X	64.6
			1000	A 39 6 1 X X C X	74.5
		800	675	A 39 8 6 X X C X	68.5
			875	A 39 8 8 X X C X	75.5
			915	A 39 8 9 X X C X	78.2
			1000	A 39 8 1 X X C X	98.1
42U	2000*	600	675	A 42 6 6 X X C X	57.6
			875	A 42 6 8 X X C X	65.0
			915	A 42 6 9 X X C X	67.6
			1000	A 42 6 1 X X C X	77.5
			1200	A 42 6 2 X X C X	87.5
		800	675	A 42 8 6 X X C X	71.2
			875	A 42 8 8 X X C X	78.5
			915	A 42 8 9 X X C X	81.2
			1000	A 42 8 1 X X C X	91.2
			1200	A 42 8 2 X X C X	101.1
47U	2223*	600	675	A 47 6 6 X X C X	62.5
			875	A 47 6 8 X X C X	70.0
			915	A 47 6 9 X X C X	72.6
			1000	A 47 6 1 X X C X	82.5
			1200	A 47 6 2 X X C X	92.5
		800	675	A 47 8 6 X X C X	76.2
			875	A 47 8 8 X X C X	83.5
			915	A 47 8 9 X X C X	86.2
			1000	A 47 8 1 X X C X	96.1
			1200	A 47 8 2 X X C X	106.1

* Overall frame height is based on frame mounted on standard Nylon foot

Component Assembly Specification & Order Codes

Mounting Angle Only Options

Mounting Angle Only Options

The Access range is available with a range of mounting angles options that can be configured in the basic cabinet frame assembly as indicated on pages 7 & 39. If required individual rails can be ordered separately as detailed below. Each rail assembly is supplied complete with standard fixings for mounting to the Access cabinet basic frame.



Vertical 19-Inch Mounting Angles

Description	Order Code
Access 22U vertical plain 19-inch mounting angle	AVM22
Access 27U vertical plain 19-inch mounting angle	AVM27
Access 32U vertical plain 19-inch mounting angle	AVM32
Access 39U vertical plain 19-inch mounting angle	AVM39
Access 42U vertical plain 19-inch mounting angle	AVM42
Access 47U vertical plain 19-inch mounting angle	AVM47

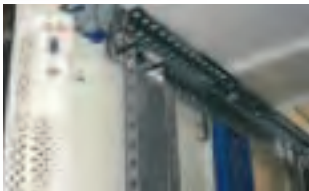

ETSI

Description	Order Code
Access 39U compatible ETSI mounting angle – 69SU	EVM39E
Access 42U compatible ETSI mounting angle – 74SU	EVM42E
Access 47U compatible ETSI mounting angle – 83SU	EVM47E



Vertical 19-Inch Mounting Angles With RCM+

Description	Order Code
Access 22U vertical 19-inch mounting angle fitted with RCM+ fingers	AVM22RCM
Access 27U vertical 19-inch mounting angle fitted with RCM+ fingers	AVM27RCM
Access 32U vertical 19-inch mounting angle fitted with RCM+ fingers	AVM32RCM
Access 39U vertical 19-inch mounting angle fitted with RCM+ fingers	AVM39RCM
Access 42U vertical 19-inch mounting angle fitted with RCM+ fingers	AVM42RCM
Access 47U vertical 19-inch mounting angle fitted with RCM+ fingers	AVM47RCM

Notes

- All rails are finished and clear zinc plate and trivalent passivate to BS EN 12329:2000 unless otherwise stated.
- Please note all part codes are for single rail assemblies unless otherwise stated.



Vertical Intermediate Rail

Description	Order Code
Access 22U vertical intermediate rail	IMP22
Access 27U vertical intermediate rail	IMP27
Access 32U vertical intermediate rail	IMP32
Access 39U vertical intermediate rail	IMP39
Access 42U vertical intermediate rail	IMP42
Access 47U vertical intermediate rail	IMP47

IMP Rails provide a side mounting facility mounted on the Access central extrusions. The rail provides a central support position for any heavy full depth equipment.



600mm Wide Server Beam

Description	Order Code
Access cabinet 600mm wide server beam	ASB600



800mm Wide Adaptor Channel

Description	Order Code
Access cabinet 800mm wide adaptor channel	AA8

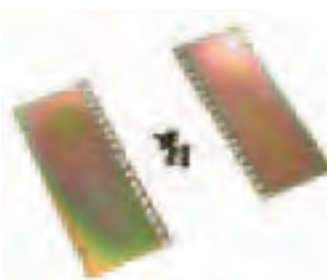

Full Width to 19-Inch Adaptor Plates

Description	Order Code
Access cabinet full width to 19-inch adaptor plates 2U (supplied in pairs)	AFWA2AS
Access cabinet full width to 19-inch adaptor plates 3U (supplied in pairs)	AFWA3AS
Access cabinet full width to 19-inch adaptor plates 6U (supplied in pairs)	AFWA6AS
Access cabinet full width to 19-inch adaptor plates 12U (supplied in pairs)	AFWA12AS

Full width to 19-inch adaptors are only compatible with the Access 800mm wide range with the mounting rails set in full width configuration. Supplied complete with fixings and assembly instructions.

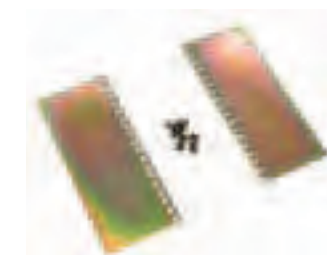

ETSI to 19-inch Adaptor Plates

Description	Order Code
Access cabinet ETSI to 19-inch adaptor plates 2U (supplied in pairs).	AEAP2AS
Access cabinet ETSI to 19-inch adaptor plates 3U (supplied in pairs).	AEAP3AS

ETSI to 19-inch adaptors allow both ETSI and 19-inch mounted equipment to be configured in the same cabinet frame. Supplied complete with fixings and assembly instructions.

Component Assembly Specification & Order Codes

Base Mounting Options

Cabinet Base Mounting Options

The Access cabinet is fitted with Nylon feet as standard which protrude 10mm below the bottom of the Access frame. The Access range offers the ability to configure the bottom of the cabinet with a range of mounting and fixing options, details of which are shown below.



Corner Adaptor Plates



Castor Kit



Jacking Foot Kit



Plinth Kit

Std Corner Adaptor Plate

Two types of corner adaptor plates are available for the Access cabinet range depending on specific mounting requirements (see chart below). These adaptor plates can be either factory fitted or supplied as a retrofit kit (must be fitted before mounting any equipment in the cabinet).

Description	Order Code	Bolt Down Facility	Jacking Feet	Castors	Jacking Feet & Castors
Access standard corner adaptor plates (Set of 4)	AJFK	✓	✓	✓	X
Access universal corner adaptor plates (Set of 4)	APKCPK	✓	✓	✓	✓ *

*The universal corner adaptor plate requires an adaptor kit to allow jacking feet and castors to be fitted at the same time – please order kit AUCPAK in addition to the adaptor plates.

Universal Corner Plate + Castor

These simply bolt onto either the standard or universal corner adaptor plates increasing the overall height of the cabinet by 87mm. The castors are supplied in set of 4 and come with a screw in brake facility.

Access castor kit (Set of 4)	ACK
------------------------------	-----

Universal Corner Plate + Jacking Foot

Like the castors these simply bolt onto either the standard or universal corner adaptor plates providing the ability to level the cabinet when mounted onto uneven surfaces.

Access jacking foot kit (Set of 4)	AJF
------------------------------------	-----

Standard Plinth Kit

The standard plinth kit comprises of four special corner adaptor plates which bolt to the underside of the cabinet raising the cabinet by a nominal 104mm. Each corner adaptor allows jacking feet and/or castors to be mounted and provides the fixing points for the removable kick plates which screw fix onto the front, rear and sides.

Cabinet Size	Order Code	Order Code (Inc. Jacking Feet)
600mm Wide x 675mm Deep	AMP66*	AMP66JF
600mm Wide x 875mm Deep	AMP68*	AMP68JF
600mm Wide x 915mm Deep	AMP69*	AMP69JF
600mm Wide x 1000mm Deep	AMP61*	AMP61JF
600mm Wide x 1200mm Deep	AMP62*	AMP62JF
600mm Wide x 1400mm Deep	AMP64*	AMP64JF
800mm Wide x 675mm Deep	AMP86*	AMP86JF
800mm Wide x 875mm Deep	AMP88*	AMP88JF
800mm Wide x 915mm Deep	AMP89*	AMP89JF
800mm Wide x 1000mm Deep	AMP81*	AMP81JF
800mm Wide x 1200mm Deep	AMP82*	AMP82JF
800mm Wide x 1400mm Deep	AMP84*	AMP84JF

* Please Note - The plinth kit requires either jacking feet or castors to be mounted to the corner adaptor plates before it can support the cabinet's weight.

Stabilising Plinth Kit

Like the standard plinth the stabilising plinth kit comprises of special corner adaptor plates with jacking foot and/or castor provision. The rear and side kick plates simply screw fix to the corner plates whilst the front kick plate pulls out to reveal a stabilising bar. The stabilising bar can be retracted after use to avoid potential trip hazards.

The standard assembly includes two jacking feet fitted to the stabilising bar but requires either jacking feet or castors to be fitted to the corner plates before the plinth assembly can support the cabinet's weight. The jacking feet and castors should be ordered separately.

Nominally the plinth assembly increases the overall height of the cabinet by 104mm.

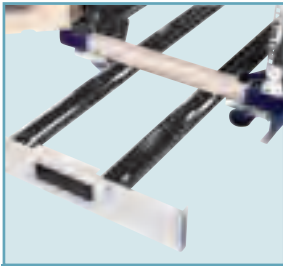

Stabilising Plinth Kit

Cabinet Size	Order Code	Order Code (Inc. Jacking Feet)
600mm Wide x 675mm Deep	SAMP66	SAMP66JF
600mm Wide x 875mm Deep	SAMP68	SAMP68JF
600mm Wide x 915mm Deep	SAMP69	SAMP69JF
600mm Wide x 1000mm Deep	SAMP61	SAMP61JF
600mm Wide x 1200mm Deep	SAMP62	SAMP62JF
600mm Wide x 1400mm Deep	SAMP64	SAMP64JF
800mm Wide x 675mm Deep	SAMP86	SAMP86JF
800mm Wide x 875mm Deep	SAMP88	SAMP88JF
800mm Wide x 915mm Deep	SAMP89	SAMP89JF
800mm Wide x 1000mm Deep	SAMP81	SAMP81JF
800mm Wide x 1200mm Deep	SAMP82	SAMP82JF
800mm Wide x 1400mm Deep	SAMP84	SAMP84JF

* Please Note - The plinth kit requires either jacking feet or castors to be mounted to the corner adaptor plates before it can support the cabinet's weight.

Computer Floor Plinth

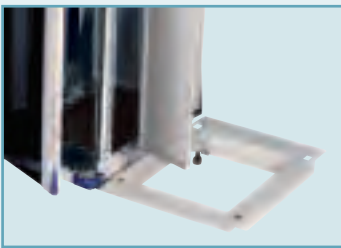

The Access computer floor plinth has been designed to mount to the pedestals of most conventional raised floor structures. Available in a range of layouts and sizes the plinth structure nominally allows cabinets to sit of a single tile depth (1200mm and 1400mm deep cabinets sit on two tiles depth wise). Although the cabinet nominally overlaps the tiles immediately in front and behind, the plinth securely raises the cabinet slightly above the floor level. This allows the tiles to the front or rear of the cabinet to be easily removed even when the cabinets are fully loaded.

The number of tiles on the width is variable and depends on the number of cabinets per plinth. Where the plinth layout does not match an exact tile spacing the plinth includes an adjustable angle to support the cut tile. Each assembly is supplied complete with all applicable fixings and clamp brackets. A range of blanking options are available and these can be tailored to meet the needs of individual installations or cabinet layouts.

This system offers potential savings as the plinth simply replaces the normal tile and helps by helping to avoid the costly cutting of tiles. The system also allows cabinets to be bayed closely together avoiding creep in layouts and maximising space within the data room.

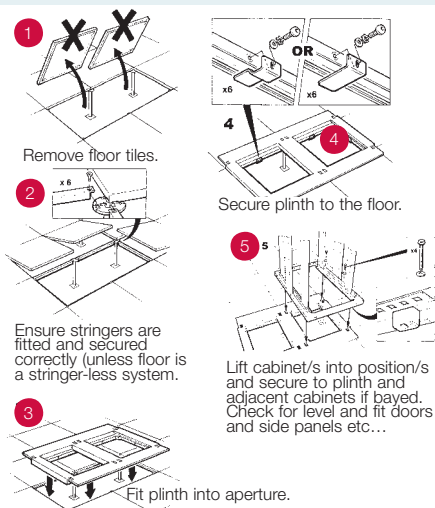

Cabinet Width (mm)	Cabinet Depth (mm)	Single Bay Option	Two Bay Option	Three Bay Option	Four Bay Option
600	675	A6FP61	A6FP63	A6FP64	A6FP64
600	875	A6FP81	A6FP83	A6FP84	A6FP84
600	975	A6FP91	A6FP93	A6FP94	A6FP94
600	1000	A6FP11	A6FP13	A6FP14	A6FP14
600	1200	A6FP21	A6FP23	A6FP24	A6FP24
600	1400	A6FP41	A6FP43	A6FP44	A6FP44
800	675	A8FP61	A8FP63	A8FP64	-
800	875	A8FP81	A8FP83	A8FP84	-
800	975	A8FP91	A8FP93	A8FP94	-
800	1000	A8FP11	A8FP13	A8FP14	-
800	1200	A8FP21	A8FP23	A8FP24	-
800	1400	A8FP41	A8FP43	A8FP44	-

Component Assembly Specification & Order Codes

Base Blanking Options

Base Panel Options

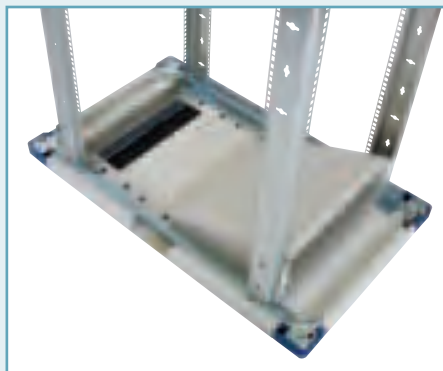
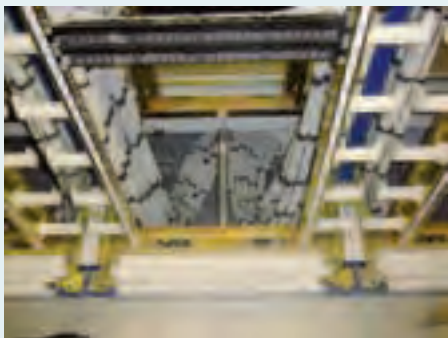

The open frame design of Cooper B-Line's Access Cabinet provides unrivalled cable entry capability thanks to its tubular frame. Whilst this scenario can be ideal for some applications other installations require the top and bottom cabinet apertures to be blanked off to reduce the ingress of dust or to control the thermal characteristics within the cabinet.

The Access cabinet base blanking panel system provides a configurable solution capable of being tailored to meet the demands of individual applications. The assembly comprises of a fixed frame which then accommodates the mounting of a range of blanking panel or air ducting options. The number of panel apertures is dependant on the depth of the cabinet with details indicated below.

The base frames can be fitted with or without either the nylon skids or jacking feet, simply bolting to the underside of the base cabinet frame. The 800mm wide variant provides a brush strip entry front to rear offering a cable aperture size of 500mm x 53mm. With the centre blanking panels removed the 800mm wide variant also offers the ability to slide the brush strip sections in board providing cabling clearance of 230mm to ease cabling installation.

For applications where the cabinet will be mounted on a level raised floor structure the standard nylon skids can be removed allowing the cabinet frame to sit directly onto the floor. This provides a seal between the floor and the cabinet removing the headache of trying to manage the sealing of the floor void at the tile level. In this configuration the brush strip cable entries in the base blanking panels effectively provide sealing around the cable bundles.

Frame Assemblies



Cabinet Width (mm)	Cabinet Depth (mm)	Blanking Locations	Order Code
600	675	2	ACBBF606B
	875	3	ACBBF608B
	1000	4	ACBBF610B
	1200	5	ACBBF612B
	1400	6	ACBBF614B
800	675	2	ACBBF806B
	875	3	ACBBF808B
	1000	4	ACBBF810B
	1200	5	ACBBF812B
	1400	6	ACBBF814B

* Please Note – Base panel assemblies are available as standard finished in black RAL 9005 only. Panels shown light grey finish for clarity only.

Blanking Assemblies



Plain Blanking Panel



Brush Strip Blanking Panel



Air Deflector Cowl



Scavenger Fan Tray Duct

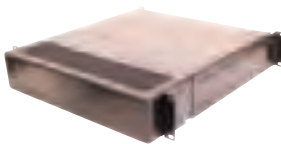

2U Scavenger Fan Tray

Description	Blanking Value	Order Code
Supplied with quick fit ¼ turn tool less fixings allowing easy fitting. Simply align the panel with the corresponding holes in the base frame and secure in position using the captive fixings to provide an effective blanking solution.	1	ACBBPPB
Like the plain blanking these units take up one unit space and also incorporate the same tool less ¼ turn fixings. The brush strip blanking panels offer a cabling aperture of 350mm x 64mm and can be fitted with the brush facing the front or rear of the cabinet. Indeed two panels can be mounted with the brush on the mating joint providing a cabling aperture of 350mm x 128mm.	1	ACBBBPB
The deflector cowl has been designed to control the air flow from the floor void immediately under the cabinet. The cowl directs the air to the area in front of the 19-inch mounting angles ensuring that the cold air can effectively feed the cooling requirements for a normally aspirated piece of active equipment. The air damper incorporated in the unit allows the user to balance the air flow to the cabinet allowing fine tuning of groups of cabinets. This unit takes up two unit blanking spaces and mounts in the bottom 3U of the cabinet.	2	ACBBDAB
Designed to be used in conjunction with the 2U Scavenger Fan Tray this unit takes up the two blanking spaces. Like the blanking panels the duct simply aligns with the corresponding holes in the base frame and secures in position using the captive tool less ¼ turn fixings.	2	ACBBSFDB
The 2U Scavenger Fan Tray simply mounts into the bottom 2U of the cabinet and rests on the Scavenger Fan Tray Cowl. The Scavenger fan tray protrudes through the 19-inch aperture by approximately 130mm and is designed, like the Air Deflector, to pull cold air from the floor void immediately under the cabinet and feed the cold air to the area in front of the 19-inch mounting angles. For further details of the fan tray please see page 88.	2	See Page 88 for Details

* Please Note – Base panel assemblies are available as standard finished in black RAL 9005 only. Panels shown light grey finish for clarity only.

Component Assembly Specification & Order Codes

Top Panel Options

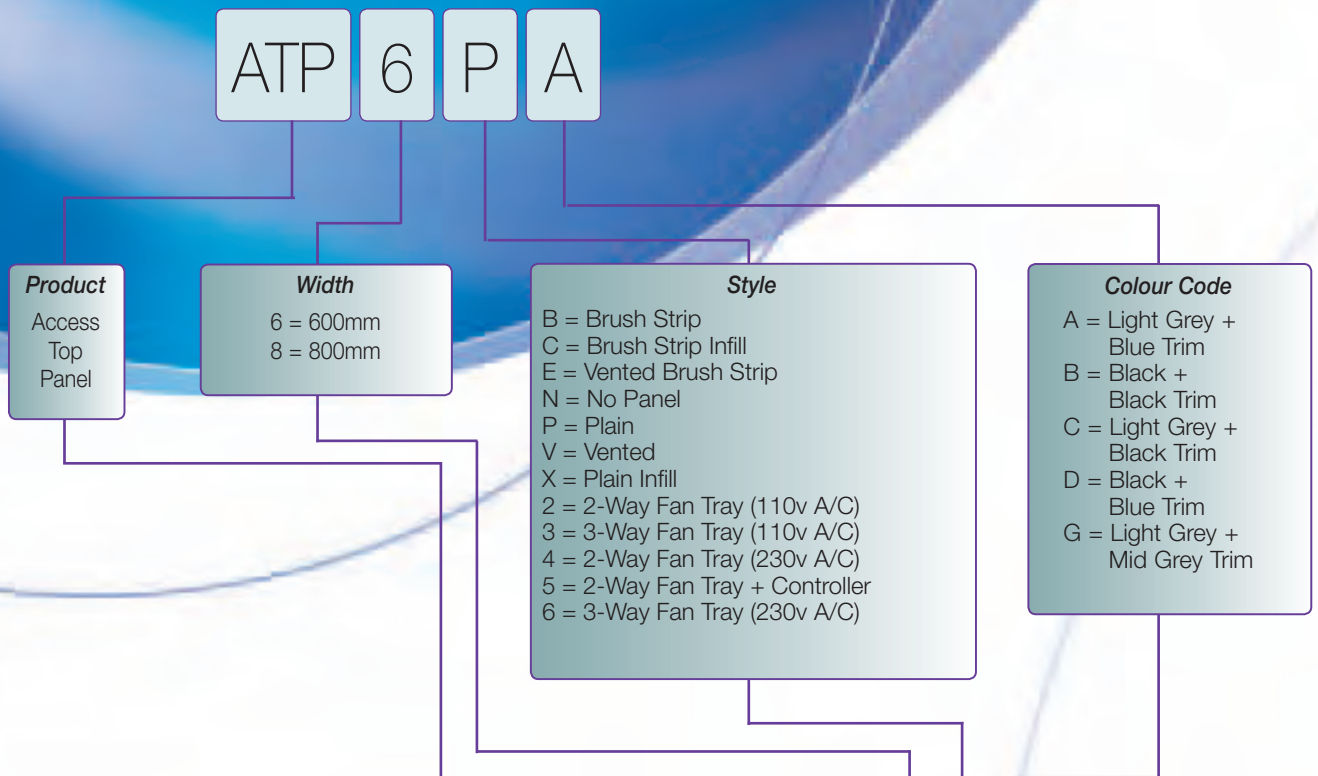

Designed for exceptional flexibility by using separate interchangeable panels

The panels can be fitted in various positions, giving you a wide choice of combinations to suit your application. Panels can be completely removed for a totally open cable access area if required.

For optimum forced air cooling, fans are offset within the panel. The tray can then be rotated through 180° to 'fine tune' the cooling system when equipment is mounted within the cabinet.

For full details of top panel configurations see page 46.



Top Panel Style	Frame Width (mm)	Order Code See Legend to Complete Part Number				Shipping Weight (kg)
		A	W	S	C	
Plain	600	A	6	P	■	1.8
	800	A	8	P	■	2.2
Vented	600	A	6	V	■	1.2
	800	A	8	V	■	1.5
Brush Strip Entry	600	A	6	B	■	1.9
	800	A	8	B	■	2.2
2 - Way Fan Tray 110v AC	600	A	6	2	■	3.2
	800	A	8	2	■	3.6
3 - Way Fan Tray 110v AC	600	A	6	3	■	3.9
	800	A	8	3	■	4.3
2 - Way Fan Tray 230v AC	600	A	6	4	■	3.2
	800	A	8	4	■	3.6
Fan Tray with TCM1000 with thermal control unit	600	A	6	5	■	3.9
	800	A	8	5	■	4.3
3 - Way Fan Tray 230v AC	600	A	6	6	■	3.9
	800	A	8	6	■	4.3
Infill for Cab. Depth 915	600	A	6	X	■	3.2
	800	A	8	X	■	3.6
Infill for Cab. Depth 875/1200	600	A	6	Y	■	3.9
	800	A	8	Y	■	4.3



Roof Mounted Fan Trays

Description	Width mm	Order Code
2-Way Fan Tray – 230v AC	600	ATP64A
2-Way Fan Tray – 230v AC	800	ATP84A
3-Way Fan Tray – 230v AC	600	ATP66A
3-Way Fan Tray – 230v AC	800	ATP86A
2-Way Fan Tray – 110v AC	600	ATP62A
2-Way Fan Tray – 110v AC	800	ATP82A
3-Way Fan Tray – 110v AC	600	ATP63A
3-Way Fan Tray – 110v AC	800	ATP83A



Thermally Controlled & Monitored Roof Fan trays

Description	Width	Order Code
Monitored fan tray	600mm	ATP65A
Monitored fan tray	800mm	ATP85A

Overview

Thermal management within 19" cabinets has always proved challenging. The Access range provides effective natural convection cooling within its core design. Where additional forced cooling is necessary Cooper B-Line offer a range of complementary products to enhance system cooling.

Roof Mounted Fan Trays

Features:-

- Replaces vented or plain top panels.
- Simple 2 fastener fixing.
- Can be turned through 180°.
- Can be fitted at front, centre and rear (centre on 875mm or deeper cabinets only).

Technical Overview:-

- Metalwork 1.2mm powder coated mild steel.
- Power bracket 2mm zinc plated mild steel.

Fan Specification:-

- Airflow - 160m³ per hour
- Speed - 2650 r.p.m.
- Current - 0.12 amps.
- Noise Level - 42dB
- Voltage - 230V AC.

Thermally Controlled and Monitored Fan Trays

Constantly monitoring its surroundings, and adjusting fan speed by temperature, the Monitored Roof Fan Tray is available in 600mm and 800mm wide versions and represents the latest ideas in thermal management.

Features:-

- Replaces vented or plain top panels.
- Simple 2 fastener fixing.
- Can be turned through 180°.
- Can be fitted at front, centre and rear (centre on 875mm or deeper racks only).
- Dual thermistor control.
- Volt-free relay output and tri-colour LED for alarm outputs.
- Fan failing alarm.
- Thermistor failure and over-temperature alarm.
- User programmable temperature settings.

Technical Overview:-

- Metalwork 1.2mm powder coated mild steel.

Fan Specification:-

- Speed - Variable.
- Noise level - Variable.
- Voltage - 100/230V AC input - 12V DC fans.

Order codes denote products finished std light grey & blue



Component Assembly Specification & Order Codes

Side Panel Options

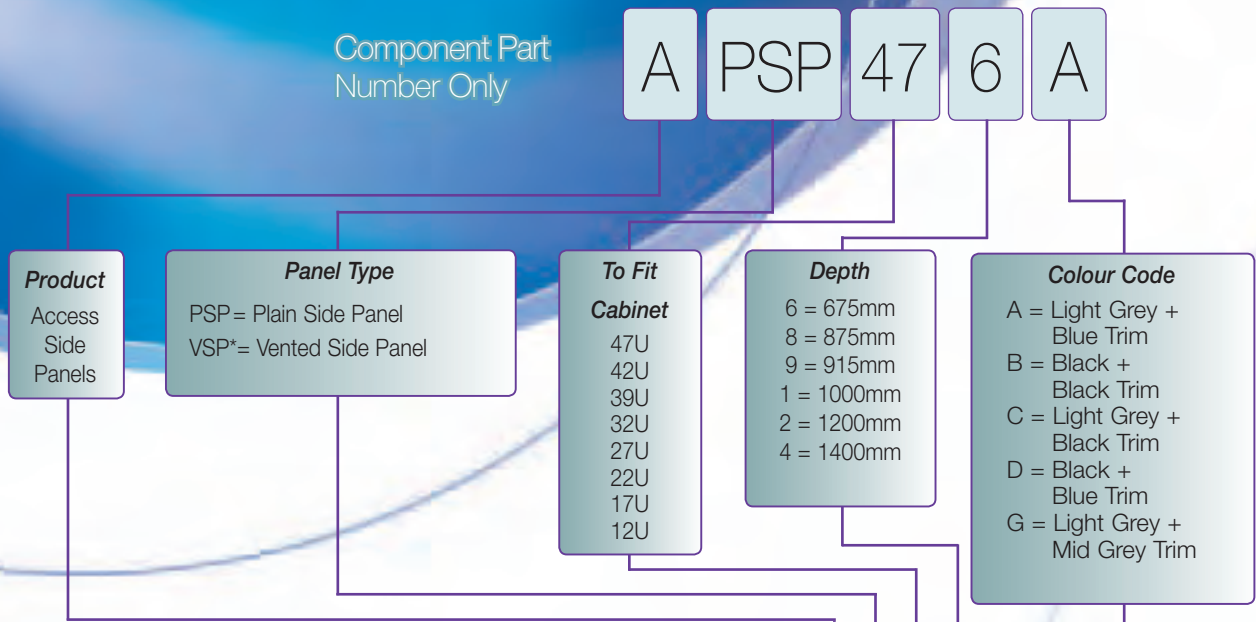

* Vented Side Panels are only available in 42U and 47U heights and in depths of 875mm, 1000mm and 1200mm.

Side panels are supplied as a twin set per side.

- Split depth for space saving and easy access
- Pivots left or right on internal quick release latches
- Lightweight, easily removed



Items marked * are either held as limited stock or made to order. Please contact our customer services team for availability.

Height Usable EIA Mtg. Units	Depth (mm)	Part Number				Shipping Weight (kg)	
		See Legend Above to Complete Part Number					
47U	675	A	■	47	6	■	14.8
	875	A	■	47	8	■	19.2
	915	A	■	47	9	■	20.1
	1000	A	■	47	1	■	22.0
	1200	A	■	47	2	■	26.4
	1400	A	■	47	4	■	30.8
42U	675	A	■	42	6	■	13.3
	875	A	■	42	8	■	17.8
	915	A	■	42	9	■	18.1
	1000	A	■	42	1	■	19.8
	1200	A	■	42	2	■	23.7
	1400	A	■	42	4	■	27.7
39U	675	A	■	39	6	■	12.4
	875	A	■	39	8	■	16.1
	915	A	■	39	9	■	16.9
	1000	A	■	39	1	■	18.5
32U	675	A	■	32	6	■	10.4
	875	A	■	32	8	■	13.6
	915	A	■	32	9	■	14.1
	1000	A	■	32	1	■	15.4
27U	675	A	■	27	6	■	8.9
	875	A	■	27	8	■	11.4
	915	A	■	27	9	■	12.1
	1000	A	■	27	1	■	13.2
22U	675	A	■	22	6	■	7.4
	875	A	■	22	8	■	9.7
17U	675	A	■	17	6	■	5.9
	875	A	■	17	8	■	8.0
12U	675	A	■	12	6	■	4.4
	875	A	■	12	8	■	6.3

Component Assembly Specification & Order Codes

Door Options

A GD 47 6 A CL

Access

Door Type

AD = Acrylic Glazed Door – LH
 BD = Acrylic Glazed Door – RH
 CT = Access Cover Trims
 GD = Glazed Door (Vented Styles) – LH
 FD = Glazed Door (Vented Styles) – RH
 HFD = High Flow Server Door With Metal Trims – LH
 HGD = High Flow Server Door With Metal Trims – RH
 DGD = Wardrobe Style Double Glazed Doors – LH
 HD = Glazed Door (Non Vented Styles) – LH
 PD = Glazed Door (Non Vented Styles) – RH
 VPD = Pressurised Rear Door – LH
 VRD = Pressurised Rear Door – RH
 SD = Plain Steel Door – LH
 TD = Plain Steel Door – RH
 VD = Vented Steel Door – LH
 WD = Vented Steel Door – RH
 DSD = Wardrobe Style Double Plain Steel Doors
 ZD = Wardrobe Style Double Vented Steel Doors

To Fit Cabinet

47 = 47U
 42 = 42U
 39 = 39U
 32 = 32U
 27 = 27U
 22 = 22U
 17 = 17U
 12 = 12U

Cabinet Width

6 = 600mm
 8 = 800mm

Colour Code

A = Light Grey + Blue Trim
 B = Black + Black Trim
 C = Light Grey + Black Trim
 D = Black + Blue Trim
 G = Light Grey + Mid Grey Trim

Colour Code

Blank = Std Swing Handle
 CL = Combination Lock Swing Handle
 EL = Euro Lock Swing Handle (no insert)
 IP = i-PAL Swing Handle

Access Acrylic Door

The Access Cabinet Acrylic Glazed Door is made up of a door frame with a 4mm clear Perspex window clamped into the glazing aperture. Door features are as follows;

- Doors can be supplied left hand or right hand hinged.
- Supplied with two point locking espan assembly latching into the cabinet frame top and bottom.
- Fitted with keyed swing handle as standard.
- Other locking options available including Euro profile inserts, mechanical combination swing handle and i-PAL electronic locking.

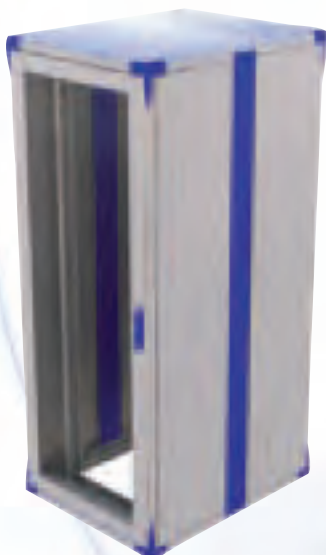

To Fit Cabinet	Width (mm)	Shipping Weight (kg)	Order Code
47U	600	20.2	A X 47 6 A X
42U		18.0	A X 42 6 A X
39U		15.0	A X 39 6 A X
32U		10.2	A X 32 6 A X
27U		5.9	A X 27 6 A X
47U	800	25.2	A X 47 8 A X
42U		22.5	A X 42 8 A X
39U		18.7	A X 39 8 A X
32U		12.7	A X 32 8 A X
27U		7.3	A X 27 8 A X

Sample code for a left hand hinged 42U x 600mm wide assembly with standard locking – AAD426A

Component Assembly Specification & Order Codes

Door Options Cont.

Access Cover Trims

The Access Cabinet Cover Trims provide the ideal solution when constant access is required to the 19-inch equipment.

- Comprises of two vertical hinged styles, the cover trims are simply secured in the closed position using simple magnets top and bottom.
- Cover trims allow vertical cabling to be discreetly covered leaving full view of the complete 19-inch aperture.



To Fit Cabinet	Width (mm)	Shipping Weight (kg)	Order Code
47U	600	6.8	A CT 47 6 A XX
42U		6.1	A CT 42 6 A XX
39U		5.7	A CT 39 6 A XX
47U	800	6.8	A CT 47 8 A XX
42U		6.1	A CT 42 8 A XX
39U		5.7	A CT 39 8 A XX

Sample code for a 42U x 800mm wide assembly - ACD428A

Access Standard Glazed Doors

The standard Access Cabinet Glazed Door is made up of two vertical vented door styles with a piece of 4mm tinted toughened glass structurally bonded to the styles. The vertical vent pattern on each of the doors styles provides some air flow into the cabinet but of applications where active equipment is deployed it is recommended that the Access Vented Steel Door or the Access High Flow Server Door is specified.

Features include;

- Colour coded hardware incorporating quick release hinge mechanisms.
- Doors can be supplied left hand (AGD series) or right hand (AWD series) hinged.
- Supplied with two point locking espan assembly latching into the cabinet frame top and bottom.
- Fitted with keyed swing handle as standard.
- Other locking options available including Euro profile inserts, mechanical combination swing handle and i-PAL electronic locking.



To Fit Cabinet	Width (mm)	Shipping Weight (kg)	Order Code
47U	600	16.0	A X 47 6 A XX
42U		14.3	A X 42 6 A XX
39U		13.3	A X 39 6 A XX
32U		10.9	A X 32 6 A XX
27U		9.2	A X 27 6 A XX
22U		7.5	A X 22 6 A XX
17U		5.8	A X 17 6 A XX
12U	4.1	A X 12 6 A XX	
47U	800	21.3	A X 47 8 A XX
42U		19.1	A X 42 8 A XX
39U		17.7	A X 39 8 A XX
32U		14.5	A X 32 8 A XX
27U		12.3	A X 27 8 A XX
22U		10.0	A X 22 8 A XX
17U		7.7	A X 17 8 A XX
12U		5.4	A X 12 8 A XX

Sample code for a left hand hinged 42U x 600mm wide assembly with standard locking - AGD426A

Access High Flow Server Door

Equipment cooling continues to be one of the most important challenges that IT technicians and data centre manager's face today. The Access Cabinet High Flow Server Doors are designed to maintain critical enclosure security, whilst at the same time providing volume airflow for the essential thermal management of active equipment. By using a combination of high density perforated sheet, forming the door in a bowed corrugation, our engineers have been able to design a range doors to offer a minimum of 84% free area in relation to the free aperture through the 19-inch mounting angles.

These doors can retro fitted to existing Access Cabinets deployed in the field and can be hung either left or right hinged utilising the same convenient quick fit hinge found on our standard doors. In addition these doors are fully compatible with our range of standard swing handle locks, mechanical combination locks and i-PAL electronic locks continuing our evolution of modular solutions designed to grow with demand.

As well as the thermal benefits the Access Cabinet High Flow Server Door range also offers an aesthetically pleasing product with functional benefits. Doors can be supplied with the option of either blue or black colour coded moulded trims or customer configurable metal trims. The metal trims offer the opportunity to easily achieve customer centric branding or the ability to easily distinguish and identify a cabinet's function. The formed bowed door also offers additional clearance between the face of the 19-inch mounting angles and the inside face of the door ensuring that active equipment is able to operate in the most efficient way.

Features include;

- Doors can be supplied left hand or right hand hinged.
- Supplied with two point locking espan assembly latching into the cabinet frame top and bottom.
- Fitted with keyed swing handle as standard.
- Other locking options available including Euro profile inserts, mechanical combination swing handle and i-PAL electronic locking.



To Fit Cabinet	Width (mm)	Shipping Weight (kg)	Order Code
47U	600	14.0	A XXX 47 6 A XX
42U		12.7	A XXX 42 6 A XX
27U		8.7	A XXX 27 6 A XX
47U	800	15.4	A XXX 47 8 A XX
42U		14.0	A XXX 42 8 A XX
27U		9.8	A XXX 27 8 A XX

Sample code for a left hand hinged 42U x 800mm wide assembly with standard locking – AHFD428A

Access Wardrobe Style Double Glazed Doors

The Access Cabinet Wardrobe Style Double Glazed Door assembly is made up of two door sections, each comprising of two vertical door styles with a piece of 4mm tinted toughened glass structurally bonded to the styles. Door features are as follows;

- Right hand door section traps the left hand door section as standard.
- Supplied with two point locking espan assembly latching behind the cabinet frame top and bottom.
- Fitted with keyed swing handle as standard.
- Other locking options available including Euro profile inserts, mechanical combination swing handle and i-PAL electronic locking.



To Fit Cabinet	Width (mm)	Shipping Weight (kg)	Order Code
47U	600	17.9	A DGD 47 6 A XX
42U		16.0	A DGD 42 6 A XX
39U		14.9	A DGD 39 6 A XX
47U	800	23.8	A DGD 47 8 A XX
42U		21.3	A DGD 42 8 A XX
39U		19.7	A DGD 39 8 A XX

Sample code for a left hand hinged 42U x 600mm wide assembly with standard locking – ADGD426A

Component Assembly Specification & Order Codes

Door Options Cont.

Access Plain Glazed Doors

The Access Cabinet Plain Glazed Door assembly is made up of two plain vertical door styles with a piece of 4mm tinted toughened glass, structurally bonded to the styles. These doors have been specifically designed for use on cabinets fitted with the i-ACE closed loop heat exchanger units providing high density cooling solutions. Features are as follows;

- Doors can be configured as either left hand or right hand hinged.
- Supplied with two point locking espan assembly latching into the cabinet frame top and bottom.
- Fitted with keyed swing handle as standard.
- Other locking options available including Euro profile inserts, mechanical combination swing handle and i-PAL electronic locking.



To Fit Cabinet	Width (mm)	Shipping Weight (kg)	Order Code
47U	600	16.0	A XX 47 6 A XX
42U		14.3	A XX 42 6 A XX
47U	800	21.3	A XX 47 8 A XX
42U		19.1	A XX 42 8 A XX

Sample code for a left hand hinged 42U x 800mm wide assembly with standard locking – AHD428A

Access Pressurised Rear Doors

Designed to mount on the rear of the cabinet these doors have been developed to enhance the thermal characteristics of the cabinet by efficiently and effectively expelling hot air generated within the cabinet. Comprising of four main elements the door configuration can be tailored to meet the demands of individual installation thanks to the flexible design.

Outwardly the door assembly looks like a standard 80% free area vented steel door, in fact it utilises the same hinge and locking hardware found on our standard doors. As a consequence these doors can be retro fitted to existing cabinets deployed in the field and be hung either left or right hand hinged as required. Where the pressurised door differs from the standard vented door is the addition of a frame on the rear of the door which forms an enclosed plenum when enclosed with blanking panels or fans trays (see options).

- Fully configurable plenum chamber.
- Integrated vertical cable manager.
- Doors can be configured as either left hand or right hand hinged.
- Supplied with two point locking espan assembly latching into the cabinet frame top and bottom.
- Fitted with keyed swing handle as standard.
- Other locking options available including Euro profile inserts, mechanical combination swing handle and i-PAL electronic locking.

To Fit Cabinet	Width (mm)	Shipping Weight (kg)	Order Code
47U	600	24.7	A XXX 47 6 A XX
42U		22.4	A XXX 42 6 A XX
47U	800	30.3	A XXX 47 8 A XX
42U		27.4	A XXX 42 8 A XX

Sample code for a left hand hinged 42U x 800mm wide assembly with standard locking – AVPD428A

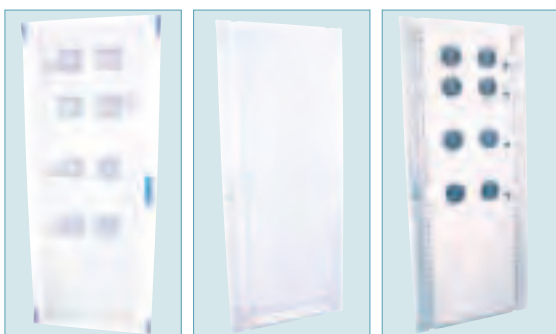

Access Pressurised Rear Door – Fan Tray Assembly

Although not 19-inch compliant the fan trays themselves are 3U in height and are fitted with two 120mm square fans each rated at 79 CFM. Utilising quick fit tool less quarter turn fixings these fan trays can be easily positioned to allow the tailored management of “Hot Spot” conditions. Power lead to be ordered seperately.



Voltage	Width (mm)	Shipping Weight (kg)	Finish	Order Code
230v A/C	600	1.65	Light Grey	A6PD3U220FTA
110v A/C		1.65		A6PD3U110FTA
230v A/C	800	1.95		A8PD3U220FTA
110v A/C		1.95		A8PD3U110FTA
230v A/C	600	1.65	Black	A6PD3U220FTB
110v A/C		1.65		A6PD3U110FTB
230v A/C	800	1.95		A8PD3U220FTB
110v A/C		1.95		A8PD3U110FTB

Access Pressurised Rear Door – Blanking Panel Options

Like the fan trays the blanking panels are not 19-inch compliant but are available in 1U or 2U height options. Used in conjunction with the fan trays the blanking panels they can be used to seal off any unused apertures in the door plenum forcing the hot air being drawn out of the back of the cabinet by the fans from re-entering or recirculating into the rear of the cabinet. The panels utilise quick fit tool less quarter turn fixings for quick and easy configuration



Voltage	Width (mm)	Shipping Weight (kg)	Finish	Order Code
1U	600	0.34	Light Grey	A6PDBP1UA
2U		0.57		A6PDBP2UA
1U	800	0.45		A8PDBP1UA
2U		0.75		A8PDBP2UA
1U	600	0.34	Black	A6PDBP1UB
2U		0.57		A6PDBP2UB
1U	800	0.45		A8PDBP1UB
2U		0.75		A8PDBP2UB

Component Assembly Specification & Order Codes

Door Options Cont.

Access Standard Plain Steel Door

The standard Access Cabinet Plain Steel Door is a single piece solid steel door. Like the Plain Glazed Doors (AHD & APD series doors) these doors can be used in applications where the i-ACE closed loop high density heat exchanger unit is deployed. The vent-less design provides the optimum condition allowing the i-ACE unit to perform efficiently. Features include;

- Colour coded hardware incorporating quick release hinge mechanisms.
- Doors can be supplied left hand (SD series) or right hand (TD series) hinged.
- Supplied with two point locking espan assembly latching into the cabinet frame top and bottom.
- Fitted with keyed swing handle as standard.
- Other locking options available inclosing Euro profile inserts, mechanical combination swing handle and i-PAL electronic locking.



To Fit Cabinet	Width (mm)	Shipping Weight (kg)	Order Code
47U	600	17.0	A XX 47 6 A XX
42U		15.2	A XX 42 6 A XX
39U		14.1	A XX 39 6 A XX
32U		11.6	A XX 32 6 A XX
27U		9.8	A XX 27 6 A XX
22U		8.0	A XX 22 6 A XX
17U		6.1	A XX 17 6 A XX
12U		4.3	A XX 12 6 A XX
47U	800	22.7	A XX 47 8 A XX
42U		20.3	A XX 42 8 A XX
39U		18.8	A XX 39 8 A XX
32U		15.4	A XX 32 8 A XX
27U		13.0	A XX 27 8 A XX
22U		10.6	A XX 22 8 A XX
17U		8.2	A XX 17 8 A XX
12U		5.8	A XX 12 8 A XX

Sample code for a left hand hinged 42U x 600mm wide assembly with standard locking – ASD426A

Access Vented Steel Door

The standard Access Cabinet Vented Steel Door has been designed to incorporate a vent pattern offering an 80% free area configuration. These doors provide the optimum solutions when configuring cabinets to meet the conventional cooling needs of low to medium density cooling applications. The percentage free area of the door is critical as the active equipment performance can be adversely affected if the flow of the cold air feed to the unit as well as the hot air exhaust are compromised.

Features include;

- Colour coded hardware incorporating quick release hinge mechanisms.
- Doors can be supplied left hand (VD series) or right hand (WD series) hinged.
- Supplied with two point locking espan assembly latching into the cabinet frame top and bottom.
- Fitted with keyed swing handle as standard.
- Other locking options available inclosing Euro profile inserts, mechanical combination swing handle and i-PAL electronic locking.



To Fit Cabinet	Width (mm)	Shipping Weight (kg)	Order Code
47U	600	16.8	A XX 47 6 A XX
42U		15.0	A XX 42 6 A XX
39U		13.9	A XX 39 6 A XX
32U		11.4	A XX 32 6 A XX
27U		9.7	A XX 27 6 A XX
22U		7.9	A XX 22 6 A XX
17U		6.1	A XX 17 6 A XX
12U		4.3	A XX 12 6 A XX
47U	800	22.4	A XX 47 8 A XX
42U		20.0	A XX 42 8 A XX
39U		18.6	A XX 39 8 A XX
32U		15.3	A XX 32 8 A XX
27U		12.9	A XX 27 8 A XX
22U		10.5	A XX 22 8 A XX
17U		8.1	A XX 17 8 A XX
12U		5.7	A XX 12 8 A XX

Sample code for a left hand hinged 42U x 600mm wide assembly with standard locking – AVD426A

Access Wardrobe Style Double Vented Steel Doors

The Access Cabinet Wardrobe Style Double Vented Steel Door assembly is made up of two half width vented steel door sections incorporating an 80% free area mesh pattern. The percentage free area of the door is critical when active equipment is deployed into the cabinet as the equipment performance can be adversely affected if the flow of the cold air feed to the unit as well as the hot air exhaust are compromised. The assembly is configured so the left hand door section is trapped by the locking right hand door section. The wardrobe style door configuration is ideal for applications with limited space around the periphery of the cabinet.

Features include;

- Colour coded hardware incorporating quick release hinge mechanisms.
- Right hand door section traps the left hand door section as standard.
- Supplied with two point locking espan assembly latching behind the cabinet frame top and bottom.
- Fitted with keyed swing handle as standard.
- Other locking options available including Euro profile inserts, mechanical combination swing handle and i-PAL electronic locking.



To Fit Cabinet	Width (mm)	Shipping Weight (kg)	Order Code
47U	600	17.2	A ZD 47 6 A X
42U		15.4	A ZD 42 6 A X
39U		14.3	A ZD 39 6 A X
47U	800	22.9	A ZD 47 8 A X
42U		20.5	A ZD 42 8 A X
39U		19.0	A ZD 39 8 A X

Sample code for a left hand hinged 42U x 800mm wide assembly with standard locking – AZD428A

Shelf Options



Chassis Supports

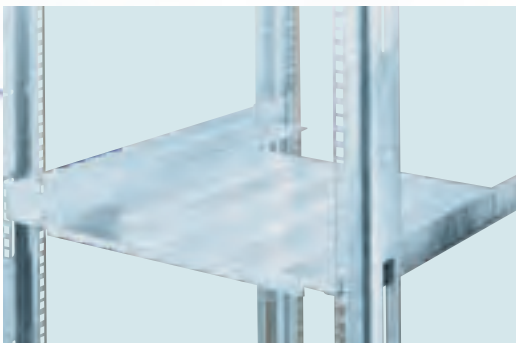

Chassis Tray

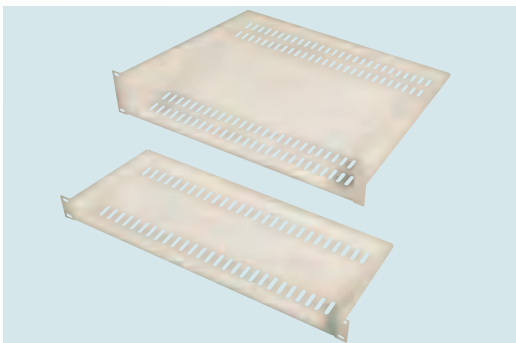

Cantilever Shelves

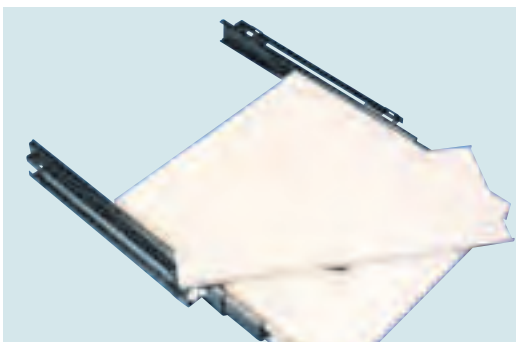

Sliding Keyboard Shelf

Chassis Support

Fix directly between front/rear 19-inch mounting angles to accept standard vented 'chassis tray' (order separately) or customer's equipment.

Materials and Finish:

- 1.5mm steel, zinc plated, colour passivated.

Description	Depth	Order Code
Chassis runners (2off)	380	CR39
Chassis runners (2off)	444	CR45
Chassis runners (2off)	571	CR58
Chassis runners (2off)	627	CR62

Chassis Trays

Ventilated tray with fixings to fit directly on chassis runners (order separately). Two depths, 230 or 455mm.

Materials and Finish:

- 1.5mm steel, zinc plated, colour passivated.

Description	Depth	Order Code
Chassis tray	230	USCT230
Chassis tray	455	USCT455

Cantilever Shelves

Fit to front face of 19-inch mounting angles, with angles set at standard 19-inch width. Ideal for modems, hubs or other networking equipment.

Materials and Finish:

- 1.5mm steel, painted light grey

Description	Height 'U'	Depth	Order Code
19-inch Front Mounted	1	190	MS19
19-inch Front Mounted	2	400	MS40
19-inch Front Mounted	3	400	MS403

Sliding Keyboard Shelf

Enables a standard keyboard to be used with any 19-inch cabinet. Turntable permits a keyboard which is wider than 450mm to be turned through 90° for storage. Universal mounting brackets fit uprights set between 450 & 750mm apart.

Features:

- Painted light grey
- Depth adjustable between 450 & 750mm
- Universal mounting fits any standard 19-inch cabinet

Description	Order Code
Sliding Keyboard Shelf	KT750

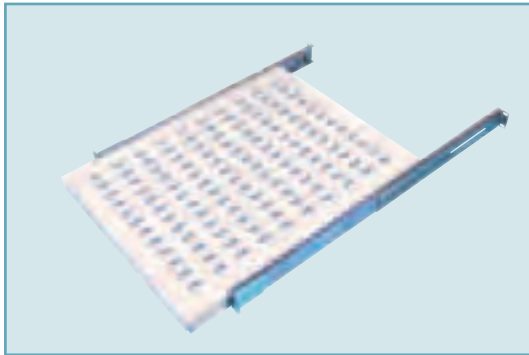

Universal Fit Sliding Shelf

To Suit Access & Other 19-inch Enclosures with Front & Rear IEC Fixings

- Vented Shelf to Assist Convection
- Adjustable Rear Bracket
- Fits any 19-inch cabinet by utilising front and rear mountings

Structure:

Designed for loads up to 45kg when supported equally on the vertical panel mounting angles.

Assembly:

Shelf, pair of Slides, 2 Front Angles, 2 Rear Brackets, M4 Screws washers & nuts, M6 cage nuts and screws.

Materials:

Shelf constructed in 1.5mm CR4 Mild Steel

Finish:

Natural Colour System NCS-1502-Y Light Grey Structured Epoxy Polyester Powder DFT 50 Microns

Min-Max Front to Rear 19-inch rail spacing	Shelf Depth	Order Code
444 - 749	455mm	LDATSV45
444 - 812	555mm	LDATSV55
444 - 940	705mm	LDATSV70

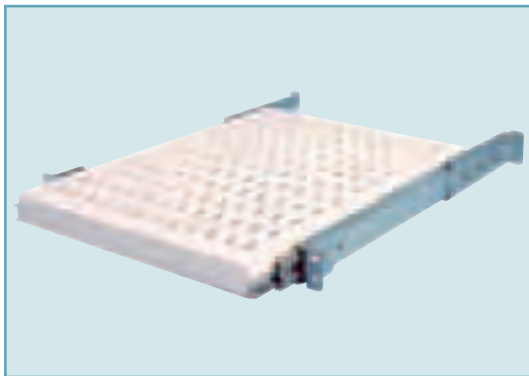

Heavy Duty Sliding Shelf

To Suit Access & Other 19-inch cabinets with Front & Rear IEC Fixings

- Vented Shelf to Assist Convection
- Adjustable Rear Bracket
- Unique Fitting Requires No Tools*

Structure:

Designed for loads up to 125kg when supported equally on the vertical panel mounting angles.

Assembly:

Shelf, pair of Slides, 2 Front Angles, 2 Rear Brackets & 4 Fixing Screws.
* For permanent fixing. (Posidrive screw driver required).

Materials:

Shelf constructed in 1.5mm CR4 Mild Steel

Finish:

Natural Colour System NCS-1502-Y Light Grey Structured Epoxy Polyester Powder DFT 50 Microns

Min-Max Front to Rear 19-inch Rail Spacing	Type	Depth	Order Code
363 - 513mm	19-inch width	450mm	QRTSV45
513 - 663mm	19-inch width	600mm	QRTSV60
663 - 813mm	19-inch width	750mm	QRTSV75
363 - 513mm	Full width	450mm	QRTSVFW45
513 - 663mm	Full width	600mm	QRTSVFW60
663 - 813mm	Full width	750mm	QRTSVFW75

Full width versions to suit 800 wide cabinets with rails fitted to extreme outside edges.

Universal Fixed Adjustable Depth Shelves

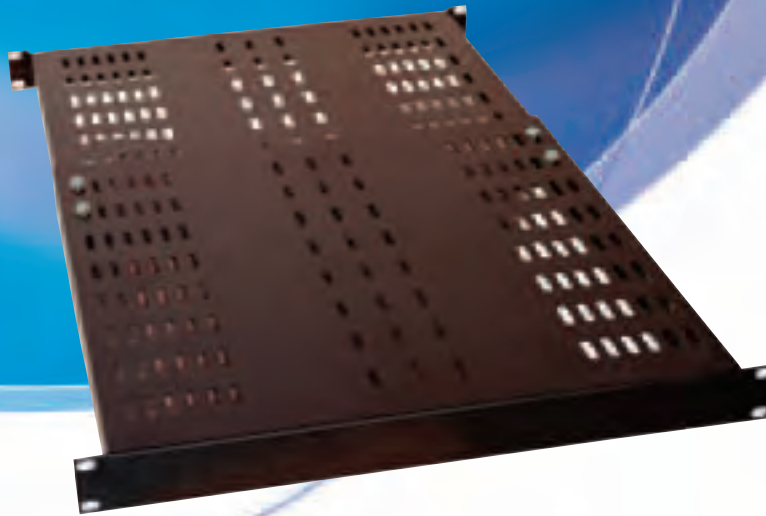

Overview

New from Cooper B-Line are a range of two 1U high 19-inch mounted fixed adjustable depth shelves. Designed to mount into any EIA 310-D / IEC 297 compliant cabinet, these shelves are adjustable in depth to suit mounting angle centres set at between 450mm and 760mm.

Available in either a standard duty or heavy duty construction the shelves have been designed and tested to provide static load ratings of 100kg and 250kg respectively (based on an evenly distributed load).

Easy to use, each shelf comes with full assembly and installation instructions. Installation is as simple as;

- Install cage nuts in the appropriate positions in the front and rear 19-inch rails.
- Adjust the shelf depth as appropriate and lightly fasten the inner shelf retaining screws.
- Screw the shelf to the front and rear 19-inch rails.
- Tighten up the inner shelf retaining screws as appropriate. Retaining screws locations are provided on the top surface of the shelf for easy access. If the top surface fixing points are inconvenient then alternative side fixing locations are provided.

Order Codes

Order Code	Description	Unit Weight	Load Rating
SDFAS1U45B	Standard Duty Fixed Adjustable Depth Shelf 1U x 450mm Deep	5kg	*100kg
HDFAS1U45B	Heavy Duty Fixed Adjustable Depth Shelf 1U x 450mm Deep	7kg	*250kg
HDFAFWS1U45B	Full Width Heavy Duty Fixed Adjustable Depth Shelf (800W ONLY) 1U x 450mm Deep	9.3kg	*250kg

* - Assumes the load is evenly distributed



Shelf Mounting Matrix

Shelving Compatibility Matrix for Access

		■ Will fit, recommended	■ Will fit	■ Will fit, NOT recommended	x Will NOT fit			19-inch upright spacing		
Part No.	Description	Shelf Depth mm	Rack Depth					3 into 2	Min mm	Max mm
			675 mm	875 mm	915 mm	1000 mm	1200 mm			
Standard 19-Inch Quick Fit Fixed Shelves - 35kg Load Rating (Uniformly Distribute)										
QRSV45	Heavy Duty Shelf 19-inch - Light Grey	450	■	■	■	■	■	X	300	450
QRSV55	Heavy Duty Shelf 19-inch - Light Grey	550	■	■	■	■	■	X	350	550
QRSV65	Heavy Duty Shelf 19-inch - Light Grey	650	X	■	■	■	■	X	450	650
QRSV75	Heavy Duty Shelf 19-inch - Light Grey	750	X	■	■	■	■	X	550	750
QRSV45B	Heavy Duty Shelf 19-inch - Black	450	■	■	■	■	■	X	300	450
QRSV55B	Heavy Duty Shelf 19-inch - Black	550	■	■	■	■	■	X	350	550
QRSV65B	Heavy Duty Shelf 19-inch - Black	650	X	■	■	■	■	X	450	650
QRSV75B	Heavy Duty Shelf 19-inch - Black	750	X	■	■	■	■	X	550	750
Full Width Quick Fit Fixed Shelves - 800mm Wide Cabinets ONLY										
QRSVFW45	Heavy Duty Shelf Full Width (800W ONLY) - Light Grey	450	■	■	■	■	■	X	300	450
QRSVFW65	Heavy Duty Shelf Full Width (800W ONLY) - Light Grey	650	X	■	■	■	■	X	450	650
QRSVFW75	Heavy Duty Shelf Full Width (800W ONLY) - Light Grey	750	X	■	■	■	■	X	550	750
QRSVFW45B	Heavy Duty Shelf Full Width (800W ONLY) - Black	450	■	■	■	■	■	X	300	450
QRSVFW65B	Heavy Duty Shelf Full Width (800W ONLY) - Black	650	X	■	■	■	■	X	450	650
QRSVFW75B	Heavy Duty Shelf Full Width (800W ONLY) - Black	750	X	■	■	■	■	X	550	750
Standard Duty 19-Inch Fixed Adjustable Depth Shelves (Black Finish Only) - 100kg Load Rating (Uniformly Distributed)										
SDFAS1U45B	Standard Duty Fixed Adjustable Depth Shelf	450	■	■	■	■	■	X	450	760
Heavy Duty 19-Inch Fixed Adjustable Depth Shelves (Black Finish Only) - 250kg Load Rating (Uniformly Distributed)										
HDFAS1U45B	Heavy Duty Fixed Adjustable Depth Shelf	450	■	■	■	■	■	X	450	760
Heavy Duty 19-Inch Fixed Adjustable Depth Shelves (Black Finish Only) - 250kg Load Rating (Uniformly Distributed)										
HDFAFWS1U45B	Full Width Heavy Duty Fixed Adjustable Depth Shelf (800W ONLY)	450	■	■	■	■	■	X	450	760
Standard Duty Sliding Shelves - 45kg Load Rating (Uniformly Distributed)										
LDATSV45	Adjustable Depth Sliding Shelf 19-inch - Light Grey	455	■	■	■	■	■	■	444	749
LDATSV55	Adjustable Depth Sliding Shelf 19-inch - Light Grey	555	■	■	■	■	■	■	444	812
LADASV70	Adjustable Depth Sliding Shelf 19-inch - Light Grey	705	X	■	■	■	■	■	444	940
LDATSV45B	Adjustable Depth Sliding Shelf 19-inch - Black	455	■	■	■	■	■	■	444	749
LDATSV55B	Adjustable Depth Sliding Shelf 19-inch - Black	555	■	■	■	■	■	■	444	812
LADASV70B	Adjustable Depth Sliding Shelf 19-inch - Black	705	X	■	■	■	■	■	444	940
Heavy Duty Sliding Shelves - 125 kg Load Rating (Uniformly Distributed)										
QRTSV45	Heavy Duty Adjustable Depth Sliding Shelf 19-inch - Light Grey	450	■	■	■	■	■	■	363	513
QRTSV60	Heavy Duty Adjustable Depth Sliding Shelf 19-inch - Light Grey	600	■	■	■	■	■	■	513	663
QRTSV75	Heavy Duty Adjustable Depth Sliding Shelf 19-inch - Light Grey	750	X	■	■	■	■	■	663	813
QRTSV45B	Heavy Duty Adjustable Depth Sliding Shelf 19-inch - Black	450	■	■	■	■	■	■	363	513
QRTSV60B	Heavy Duty Adjustable Depth Sliding Shelf 19-inch - Black	600	■	■	■	■	■	■	513	663
QRTSV75B	Heavy Duty Adjustable Depth Sliding Shelf 19-inch - Black	750	X	■	■	■	■	■	663	813
Heavy Duty Full Width Sliding Shelves 800mm Wide Cabinet ONLY - 125 kg Load Rating (Uniformly Distributed)										
QRTSVFW45	Heavy Duty Adjustable Depth Sliding Shelf Full Width - Light Grey450	450	■	■	■	■	■	X	363	513
QRTSVFW60	Heavy Duty Adjustable Depth Sliding Shelf Full Width - Light Grey600	600	■	■	■	■	■	X	513	663
QRTSVFW75	Heavy Duty Adjustable Depth Sliding Shelf Full Width - Light Grey750	750	X	■	■	■	■	X	663	813
QRTSVFW45B	Heavy Duty Adjustable Depth Sliding Shelf Full Width - Black 450	450	■	■	■	■	■	X	363	513
QRTSVFW60B	Heavy Duty Adjustable Depth Sliding Shelf Full Width - Black 600	600	■	■	■	■	■	X	513	663
QRTSVFW75B	Heavy Duty Adjustable Depth Sliding Shelf Full Width - Black 750	750	X	■	■	■	■	X	663	813
Cantilever Shelves - 35 kg Load Rating (Uniformly Distributed)										
MS19	1U Light Grey	190	■	■	■	■	■	■		
MS40	2U Light Grey	400	■	■	■	■	■	■		
MS403	3U Light Grey	400	■	■	■	■	■	■		
MS19B	1U Black	190	■	■	■	■	■	■		
MS40B	2U Black	400	■	■	■	■	■	■		
MS403B	3U Black	400	■	■	■	■	■	■		
Keyboard Shelves - 35 kg Load Rating (Uniformly Distributed)										
KT750	Adjustable Depth - Light Grey	450	■	■	■	■	■	■	450	750
KT750B	Adjustable Depth - Black	450	■	■	■	■	■	■	450	750

Vertical Cable Management Options

Vertical Cable Management

The Access cabinet range offers a choice of solutions when it comes to vertical cable management within the cabinet. With the corner-less design of the Access frame it is possible to locate and install cable management in locations not normally available with conventional four post cabinet designs. The following pages provide an overview to the solutions available.

Access Vertical Cable Tray

The Access cable tray provides full height cable management functionality including the ability to mount PDUs. The cable tray fixes directly to the adjustable side mount facility on the top and bottom Access frame providing the capability to position the cable tray in almost any position within the cabinet front to rear. Available in two width options the cable trays are supplied complete with all applicable fixings and mounting instructions.

- Cable trays are finished as standard zinc plate and trivalent passivate to BS EN 12329:2000.



Description	Order Code
Access 22U Cable Tray – 75mm Wide	ACTR22
Access 27U Cable Tray – 75mm Wide	ACTR27
Access 32U Cable Tray – 75mm Wide	ACTR32
Access 39U Cable Tray – 75mm Wide	ACTR39
Access 42U Cable Tray – 75mm Wide	ACTR42
Access 47U Cable Tray – 75mm Wide	ACTR47
Access 22U Cable Tray – 150mm Wide	ACTRW22
Access 27U Cable Tray – 150mm Wide	ACTRW27
Access 32U Cable Tray – 150mm Wide	ACTRW32
Access 39U Cable Tray – 150mm Wide	ACTRW39
Access 42U Cable Tray – 150mm Wide	ACTRW42
Access 47U Cable Tray – 150mm Wide	ACTRW47

Access Vertical Cable Basket

The Access cable basket like the cable tray provides full height cable management functionality but with the added functionality that basket brings. The cable basket can be fixed to the adjustable side mount facility on the top and bottom Access frame or bolted directly to the central vertical frame extrusions. Available in two width options the cable baskets are supplied complete with all applicable fixings and mounting instructions.

- Cable baskets are finished as standard zinc plate and trivalent passivate to BS EN 12329:2000.



Description	Order Code
Access 22U Cable Basket – 150mm Wide	ABS2215
Access 27U Cable Basket – 150mm Wide	ABS2715
Access 32U Cable Basket – 150mm Wide	ABS3215
Access 39U Cable Basket – 150mm Wide	ABS3915
Access 42U Cable Basket – 150mm Wide	ABS4215
Access 47U Cable Basket – 150mm Wide	ABS4715
Access 22U Cable Basket – 300mm Wide	ABS2230
Access 27U Cable Basket – 300mm Wide	ABS2730
Access 32U Cable Basket – 300mm Wide	ABS3230
Access 39U Cable Basket – 300mm Wide	ABS3930
Access 42U Cable Basket – 300mm Wide	ABS4230
Access 47U Cable Basket – 300mm Wide	ABS4730

Access Central Velcro Cable Tray & Basket Assemblies

For some applications it is preferable to manage the incoming cabling centrally across the width of the cabinet. The Access range offers the ability to configure the cabinet in this layout allowing cables to be brought up centrally before being split and presented to either the front or rear 19-inch mounting facility. In addition to the standard cable baskets detailed previously a range of Velcro style cable trays are also available, details below.

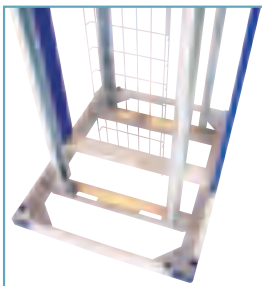

Description	Finish	Order Code
Access 600mm Wide Central Cable Support Kit	Light Grey	ACCSK06A
Access 800mm Wide Central Cable Support Kit		ACCSK08A
Access 27U Velcro Cable Tray – 300mm Wide	Light Grey	ACVT2230
Access 39U Velcro Cable Tray – 300mm Wide		ACVT3930
Access 42U Velcro Cable Tray – 300mm Wide		ACVT4230
Access 47U Velcro Cable Tray – 300mm Wide		ACVT4730
Access 27U Velcro Cable Tray – 400mm Wide	Light Grey	ACVT2240
Access 39U Velcro Cable Tray – 400mm Wide		ACVT3940
Access 42U Velcro Cable Tray – 400mm Wide		ACVT4240
Access 47U Velcro Cable Tray – 400mm Wide		ACVT4740
Access 27U Velcro Cable Tray – 600mm Wide	Light Grey	ACVT2260
Access 39U Velcro Cable Tray – 600mm Wide		ACVT3960
Access 42U Velcro Cable Tray – 600mm Wide		ACVT4260
Access 47U Velcro Cable Tray – 600mm Wide		ACVT4760
Access 27U Velcro Cable Tray – 800mm Wide	Light Grey	ACVT2280
Access 39U Velcro Cable Tray – 800mm Wide		ACVT3980
Access 42U Velcro Cable Tray – 800mm Wide		ACVT4280
Access 47U Velcro Cable Tray – 800mm Wide		ACVT4780

Vertical Cable Management Options Cont.



RCM+ Cable Management

Fix directly between front/rear 19-inch mounting angles to accept standard vented 'chassis tray' (order separately) or customer's equipment.

Materials and Finish:

- 1.5mm steel, zinc plated, colour passivated.

RCM+ Vertical Cable Manager Compatibility Chart

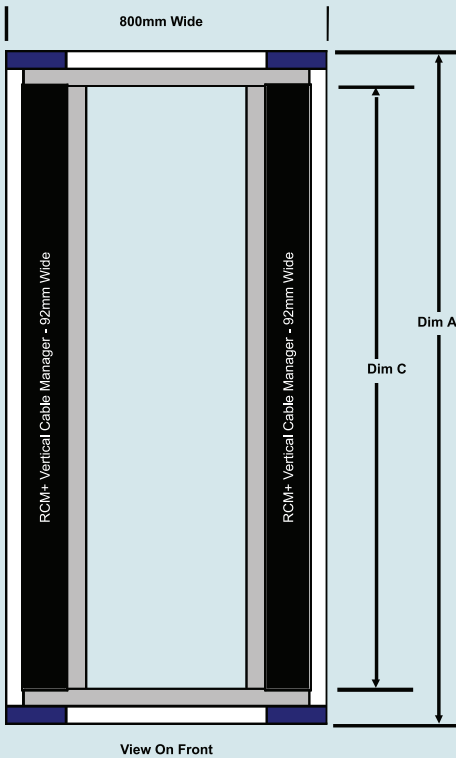

Access Cabinet Height	Dimension A*	Dimension C	Vertical Manager Size & Part Code						
			1597	1775	1952	2041	2219	2397	2664
12 U	667.0	547.8	SB86083S066	SB86083S072	SB86083S078	SB86083S084	SB86083S090	SB86083S096	SB86083S108
15 U	800.4	681.2							
18 U	933.7	814.5							
22 U	1111.5	992.3							
27 U	1333.8	1214.6							
32 U	1556.0	1436.8							
39 U	1867.2	1748.0							
42 U	2000.5	1881.3							
47 U	2222.8	2103.6							

- Dimension A is the cabinet height less the standard nylon feet.
- Cells coloured BLACK indicate that the vertical manager will mount into the side of an 800mm wide Access cabinet.
- The layout assumes that the mounting rails are set at 19-inch centres and mounted in the central position.

RCM+ Vertical High Density Single Sided Cable Manager

Size - 92mm Wide x 238mm Deep

Order Code	RCM+ Rack Height In.	mm	Dimension "B" mm
SB86083S066	66	1676	1597
SB86083S072	72	1829	1775
SB86083S078	78	1981	1952
SB86083S084	84	2133	2041
SB86083S090	90	2286	2219
SB86083S096	96	2438	2397
SB86083S108	108	2743	2664



ACH6

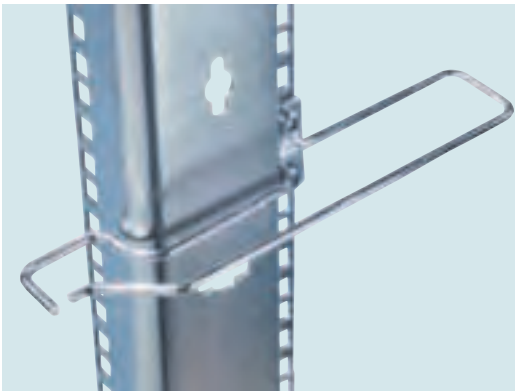

ACH6



ACH8

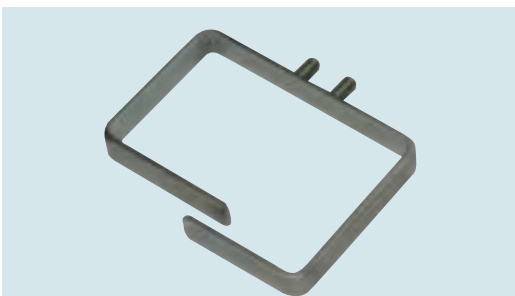

CTM17 Cable Hoop

Metal Cable Hoops

The unique design of the Access Cabinet, without corner posts, makes it the most suited enclosure product on the market to aid fast and efficient cable management.

Vertical cable management is a common problem with conventional cabinet construction but with Access it is possible to fit cable hoops to the front or rear 19-inch uprights, within the 600mm overall width footprint, whilst still allowing front entry/exit of cables. This is particularly important when racks are bayed together.

This new cable management solution provides a minimum cable area of 1550mm² on a 600mm wide rack rising to 6500mm² on 800mm wide cabinets.

The hoops attach to the side mounting facility and can be positioned to suit individual cabling applications.

ACH6 Features

- Designed to maximise cable management facilities within 600mm or 800mm wide cabinets.
- Offers 1550mm² of internal cable management space.
- Fits directly onto Cooper B-Line's Access 19-inch mounting angle ancillary mounting positions.
- Can be fitted every 1U if required.
- Does NOT compromise your 19-inch mounting facility.

ACH8 Features

- Fits directly onto Cooper B-Line's Access 19-inch mounting angle ancillary mounting positions. (suitable for 800mm wide racks only)
- Offers 6500mm² of internal cable management space.
- Can be fitted every 1U if required.
- Does NOT compromise your 19-inch mounting facility.
- Offers simplified vertical cable management whilst still offering an open architecture.

Technical Overview

- Hoop - ø5mm Zinc Plated mild steel Bar.
- Plate - 3mm thick Zinc Plated mild steel.
- Finish - Zinc Plated and Yellow Passivate.

Description	Order Code
Cable hoop for 600 or 800mm wide cabinet	ACH6
Cable hoop for 800mm wide cabinet	ACH8

Cable Hoop

Description	Order Code
Access 800mm Wide Metal Cable Hoop	CTM17

Horizontal Cable Management

Horizontal Cable Channel

Order Code	Description
JRP1 1U	19-inch mounted jumper ring panel finished in black. Rings: 4 x 65mm deep
JRP2 2U	19-inch mounted jumper ring panel finished in black. Rings: 4 x 65mm deep.
JRP1S 1U	19-inch mounted shallow ring jumper ring panel finished in black. Rings: 4 x 35mm deep.
JRP1-5 1U	19-inch mounted jumper ring panel finished in black. Rings: 5 x 65mm deep.
JRP2-5 2U	19-inch mounted jumper ring panel finished in black. Rings: 5 x 65mm deep.
JRP1D 1U	19-inch mounted deep ring jumper ring panel finished in black. Rings: 4 x 100mm deep.
JRP2D 2U	19-inch mounted deep ring jumper ring panel finished in black. Rings: 4 x 100mm deep.
JRP1SL 1U	19-inch mounted jumper ring panel with cable through apertures - finished in black. Rings: 4 x 65mm deep.
JRP2SL 2U	19-inch mounted jumper ring panel with cable through apertures - finished in black. Rings: 4 x 65mm deep.
JRPFW1-5 1U	19-inch mounted full width jumper ring panel finished in black. Rings: 3 x 65mm deep horizontal rings and 2 x 65mm deep vertical rings.
JRPFW1-5D 1U	19-inch mounted full width jumper ring panel finished in black. Rings: 3 x 65mm deep horizontal rings and 2 x 100mm deep vertical rings.
CBJRP1	1U seven ring cable basket cable tidy Rings: 7 x 65mm deep
BSP1U 1U	Cable entry brush strip panel. Finished light grey
BSP1UB 1U	Cable entry brush strip panel. Finished black (not shown)
OBSP1 1U	Cable entry brush strip panel. Finished black (not grey as shown)
OBSP2 2U	Cable entry brush strip panel. Finished black (not grey as shown)
FPFC	Front panel fixing kit. Comprising of: 50 x M6 cheese head screws, 50 x nylon washers and 50 M6 cage nuts.

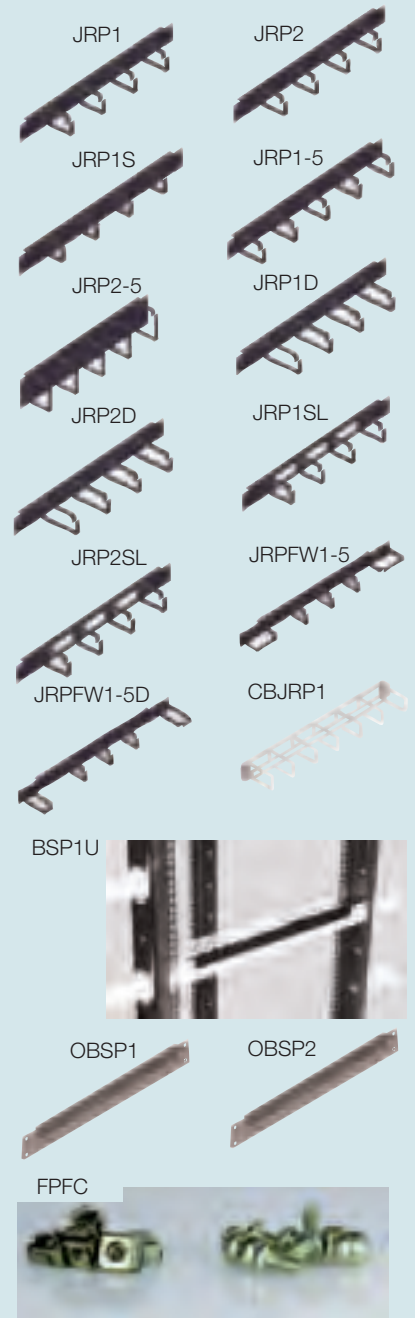

Horizontal Cable Channel

Description	Finish	Order Code
Access 600mm wide 3U high top / bottom horizontal cable channel	Standard Light Grey	AHCC600A
Access 600mm wide 3U high top / bottom horizontal cable channel	Black	AHCC600B
Access 800mm wide 3U high top / bottom horizontal cable channel	Standard Light Grey	AHCC800A
Access 800mm wide 3U high top / bottom horizontal cable channel	Black	AHCC800B

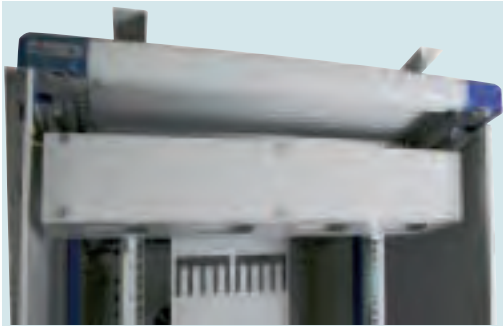

RCM+ Horizontal Cable Managers

SB-870 Series horizontal manager with snap-on removable hinged door opens past 180°, and remains open in up position for convenient cable access.

Description	Finish	Order Code
19-Inch Cable Manager – 1U High	Aluminium with UL 94V-0 black plastic components	SB-870-19S-1FB*
23-Inch Cable Manager – 1U High	Aluminium with UL 94V-0 black plastic components	SB-870-23S-1FB*
19-Inch Cable Manager – 2U High	Aluminium with UL 94V-0 black plastic components	SB-870-19S-2FB*
23-Inch Cable Manager – 2U High	Aluminium with UL 94V-0 black plastic components	SB-870-23S-2FB*
19-Inch Cable Manager – 3U High	Aluminium with UL 94V-0 black plastic components	SB-870-19S-3FB*
23-Inch Cable Manager – 3U High	Aluminium with UL 94V-0 black plastic components	SB-870-23S-3FB*

*All products with part codes finishing FB = Flat Black Finish.

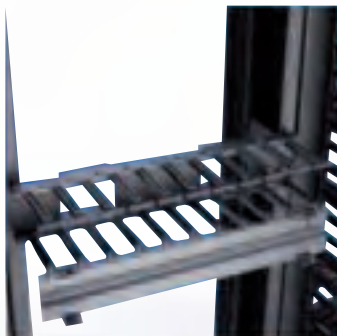

SB-870 Series



SB-870 Series

Cable Hoops & Arms



Plastic Cable Tidies



Twist & lock cable management support arms, end retainers and divider rings.



Twist & lock arms fitted to Access 19" uprights.



Enhanced twist and lock ends

Plastic Cable Tidies

With ever-increasing high density cabling applications, effective cable management is required to minimise installation times and create maximum flexibility for installers and end users alike.

To enhance the unique Access open frame, Cooper B-Line offer two sizes of plastic cable tidies. Both Large (CTL) and Small (CTS) versions share the same characteristics.

Features:-

- Fits Directly To 19-inch Panel Mounts
- Single hole fixing
- Hinged gate clip action
- Multiple mounting positions

Technical Overview:-

- Mid-Grey Plastic
- CTS 68mm x 30mm internal opening
80mm x 40mm x 26mm external dimensions
- CTL 105mm x 45mm internal opening
120mm x 60mm x 28mm external dimensions

Description	Order Code
Small mid grey tidy	CTS
Large mid grey tidy	CTL

Twist & Lock Cable Management

The new Twist and Lock cable management system is designed to fit on all Access Rack 19-inch uprights, and is also available as a 2 'U' high 19-inch panel mount version. It provides a versatile system for vertical and horizontal cable management with the large diameter ensuring the correct bend radius on cables. The arms can be fitted at any increments of 2 'U' into location holes on the 19-inch panel mounts.

Description	Order Code
Arms and ends (pack of 10)	TLCMS
Divider rings (pack of 10)	TLCMR

Enhanced Twist & Lock Ends

This addition to the twist and lock range offers greater versatility than the standard end fitting.

Description	Order Code
Enhanced twist and lock ends (pack of 10)	TLCMEF

Twist & Lock Cable Management Panel

This 2 'U' high panel incorporates up to 5 twist and lock arms to provide horizontal cabling across the rack. The large diameter arms ensure the correct bend radius on cables.

Description	Order Code
2 'U' twist and lock cable management panel	TLCMFP

Inter-rack Cable Support Bracket

This bracket has been designed specifically for supporting vertical cable trunking when fitted between bayed 800mm wide Access cabinets and also provides horizontal cable support between racks when used in conjunction with twist and lock arms.

Description	Order Code
Inter-rack support bracket	FCT88

19-Inch Blanking Panels



Tool-Less 19-Inch Blanking Panel

Tool-Less 19-Inch Blanking Panels

New to Cooper B-Line's standard product offering comes a range of Quick Fit 19-inch blanking panels. Incorporating tool-less ¼-turn fixings these panels can be easily and quickly fitted to all EIA-310-D compliant 19-inch enclosures having 19-inch square pierced mounting rails. Ideal for blanking off unused portions of the front 19-inch mounting area these panels are available in 1U, 2U and 5U increments to suit all applications.

Blanking Panel Application

Managing Airflow.

Unused vertical space in open frame racks and rack enclosures creates an unrestricted recycling of hot air that causes equipment to heat up unnecessarily. The use of blanking panels can reduce this problem.

Active equipment mounted in racks cools itself by drawing cooled air from the data centre or the raised floor environment. If any heated exhaust air is allowed to return to the air inlet of the equipment, an undesirable overheating condition may occur.

Within the rack itself the possibility exists for hot exhaust air to be recycled into the active equipment air intake.

This is mainly caused when hot exhaust air returns above or below the equipment in unused rack space.

This recycling of air is not widely appreciated by data centres and is a cause of equipment overheating. The use of blanking panels to stop hot air recirculation is a low cost solution that requires no power.

Overheating due to air recirculation and the benefits of using blanking panels are well recognized by IT equipment manufacturers, and Cooper B Line can provide a wide range of blanking panels to suit all 19-inch Rack applications.

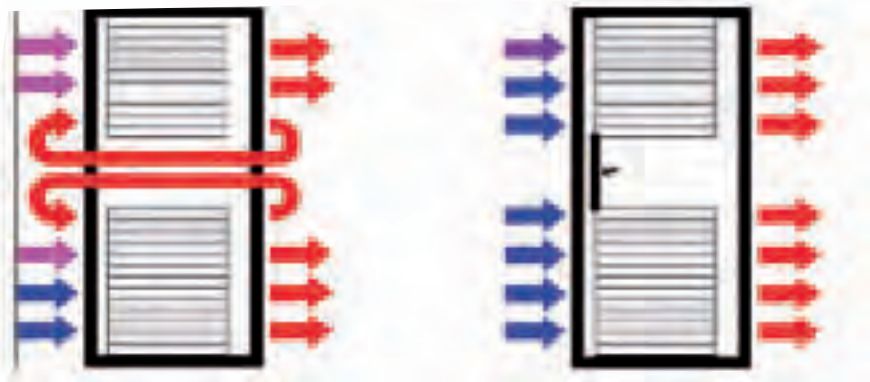

Tool-Less 19-Inch Blanking Panels

Order Code	Description	Shipping Weight
PPS1UQFB	1U 19-Inch Quick Fit Blanking Panel. 482.6mm Wide x 44.0mm High Finished RAL9005 Black	0.25kg
PPS2UQFB	2U 19-Inch Quick Fit Blanking Panel. 482.6mm Wide x 89.0mm High Finished RAL9005 Black	0.45kg
PPS5UQFB	5U 19-Inch Quick Fit Blanking Panel. 482.6mm Wide x 222.0mm High Finished RAL9005 Black	1.1kg



Front to Rear Blanking Panels

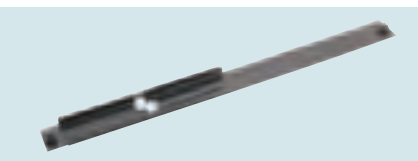
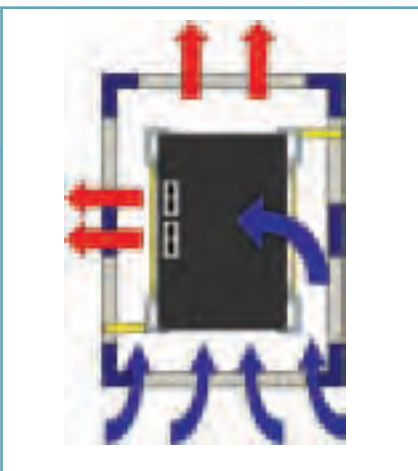

Quick Fit Adjustable Depth Switch / Server Side Blanking Panels

Designed for use in applications where both servers and switches need to be housed in a single enclosure, these quick fit adjustable depth panels form part of our modular approach to the optimisation of air-cooling within our Access cabinet solution.

Incorporating the same tool-less ¼-turn fixings as we use on our quick fit front 19-inch blanking panels these panels can be easily and quickly fitted to our Access cabinet range where the mounting angles have a side mount facility.

Available in three height (1U, 2U and 5U) and depth configurations the deployment of these quick fit adjustable depth blanking panels in conjunction with our vertical baffles and quick fit 19-inch blanking panels will allow users to conveniently optimise the air flow within the cabinet structure ensuring;

- That the cold air feed is directed to the area where it is needed allowing the servers and switches to operate efficiently.
- That the hot air expelled by any servers or switches cannot recirculate or contaminate the cold air feed.
- That the cabinet's cooling efficiency is significantly improved and as a consequence provides improved power efficiency within the data room.

This type of scenario is often associated with the deployment of network switches including the Cisco 6500 series where the switch section breathes left to right across the unit.

Technical Specifications

Material	Panel - Mild steel 1.2mm thick (18swg) Fixings – Black Polycarbonate			
Finish	Painted RAL9005 Black			
Fixing Type	Tool-less ¼ Turn Fasteners			
Order Code	Description	Dim "A"	Dim "B"	Shipping Weight
SESBP1U3QFB	1U Quick Fit Server Side Blanking Panel	422mm to 525mm	264mm to 366mm	0.25kg
SESBP1U4QFB	1U Quick Fit Server Side Blanking Panel	535mm to 638mm	376mm to 478mm	0.27kg
SESBP1U5QFB	1U Quick Fit Server Side Blanking Panel	648mm to 750mm	488mm to 590mm	0.29kg
SESBP2U3QFB	2U Quick Fit Server Side Blanking Panel	422mm to 525mm	264mm to 366mm	0.48kg
SESBP2U4QFB	2U Quick Fit Server Side Blanking Panel	535mm to 638mm	376mm to 478mm	0.52kg
SESBP2U5QFB	2U Quick Fit Server Side Blanking Panel	648mm to 750mm	488mm to 590mm	0.56kg
SESBP5U3QFB	5U Quick Fit Server Side Blanking Panel	422mm to 525mm	264mm to 366mm	3.30kg
SESBP5U4QFB	5U Quick Fit Server Side Blanking Panel	535mm to 638mm	376mm to 478mm	3.40kg
SESBP5U5QFB	5U Quick Fit Server Side Blanking Panel	648mm to 750mm	488mm to 590mm	3.50kg

Front to Rear Cable Troughs

Front to Rear Cable Troughs

Designed to further enhance Cooper B-Line's Access Cabinet System comes a range of front to rear cable trough accessories. Offering versatile adjustment these 2U high x 110mm wide trays provide unhindered front to rear cable management and include the provision for cable ties and wraps to be secured.

The cable troughs are suitable for mounting into 800mm wide Access cabinets where they simply bolt onto the side mount facility of the standard 19-inch rails. The design allows the trough to sit flush with the face of the 19-inch mounting angles allowing front horizontal cable managers to be integrated to provide a complete 360° cable management solution at any given "U" level.

The troughs are available in a range of adjustable depth options to meet the needs of all Access cabinet depth configurations. Each of the depth options has adjustment built in allowing for the depth between the front and rear 19-inch mounting angles to be adjusted, even when the trough has been cabled.



AFR2UCT-1B



AFR2UCT-2B



AFR2UCT-3B



AFR2UCT-4B

Technical Specifications & Part Codes

Material	1.2mm Mild Steel
Finish	Painted Black RAL9005
Trough Internal Dimensions	110mm Wide x 85mm High

Order Code	19-Inch Angle Centres*	Description	Shipping Weight
AFR2UCT-1B	408mm – 427mm	Access Front To Rear 2U Cable Trough – Option 1 Finished Black RAL9005	0.90kg
AFR2UCT-2B	408mm – 608mm	Access Front To Rear 2U Cable Trough – Option 2 Finished Black RAL9005	1.30kg
AFR2UCT-3B	608mm – 808mm	Access Front To Rear 2U Cable Trough – Option 3 Finished Black RAL9005	1.75kg
AFR2UCT-4B	808mm – 1008mm	Access Front To Rear 2U Cable Trough – Option 4 Finished Black RAL9005	2.20kg

* 19-Inch Mounting Angle Centres refers to the dimension between the 19-inch mounting face of the front and rear Access Cabinet 19-inch mounting angles.

600mm Wide Cabinet Vertical Baffles



Access 600mm Wide Cabinet Vertical Brush Strip Blanking Panels

Available to suit 600mm wide Access cabinets these quick fit vertical brush strip baffles have been designed to enhance the cooling efficiency of the Access cabinet by simply sealing off the area between the 19-inch mounting angle and the side panel.

One of the fundamentals for providing efficient cabinet cooling is the ability to stop hot air / cold air cross over. Not addressing this issue can result in the hot air expelled by the active equipment recirculating inside the cabinet structure. This scenario can ultimately lead to extreme hot spots, which in turn can cause premature equipment failure.

Taking a matter of minutes to fit, these vertical brush strip baffles can easily be retro fitted to all 600mm wide Access cabinets. Simply bolt the mounting brackets to the top and bottom frame and then clip the vertical baffle in position using the quick fit toolless fasteners. Once in place the vertical baffles form an effective barrier to stop hot air recirculating to the front of the cabinet. When used in conjunction with blanking panels significant improvements can be made to the cabinet's cooling efficiency.

Importantly the baffles do not affect the ability to cable down the sides of a 600mm wide cabinet. Each of the vertical baffles incorporates a brush section which allows the baffles to be either fitted over existing cables or for additional cables to be passed through. In each case the bristles on the brush effectively seal around the cables stopping leaks.

The 600mm wide baffles can be configured to suit a wide range of installations including those incorporating mixed technologies such as servers and switches.

Although the baffles can be staggered to create two "L" shaped voids Cooper B-Line recommends the use of 800mm wide cabinets for housing 19-inch mounted active equipment requiring side to side aspiration in order to maintain equipment cooling efficiency.

Technical Specifications & Order Codes

Order Code	Description	Shipping Weight
ACVBPA426A	Access Cabinet Vertical Brush Strip Baffles To suite 42U x 600mm wide cabinet Finished Light Grey NCS 1502 -Y	3.2kg
ACVBPA426B	Access Cabinet Vertical Brush Strip Baffles To suite 42U x 600mm wide cabinet Finished Black RAL9005	3.2kg
ACVBPA476A	Access Cabinet Vertical Brush Strip Baffles To suite 47U x 600mm wide cabinet Finished Light Grey NCS 1502 -Y	3.8kg
ACVBPA476B	Access Cabinet Vertical Brush Strip Baffles To suite 47U x 600mm wide cabinet Finished Black RAL9005	3.8kg

Each set comprises of
2 x Vertical brush strip baffles, 2 x Pairs of handed mounting brackets, 1 x Fixing kit.

800mm Wide Cabinet Vertical Baffles



Access 800mm Wide Cabinet Vertical Brush Strip Blanking Panels.

Available to suit 800mm wide Access cabinets these quick fit rotating vertical brush strip baffles stop hot air recirculating around to the front of the cabinet by filling in the aperture between the mounting angle and the side panel.

One of the basic requirements for providing efficient cabinet cooling is the ability to stop hot air / cold air cross over. Not addressing this issue can result in the hot air expelled by the active equipment recirculating inside the cabinet structure. This scenario can ultimately lead to extreme hot spots, which in turn can cause premature equipment failure.

Forming an effective barrier these vertical brush strip baffles can easily be configured to suit a wide range of installations including those incorporating mixed technologies such as servers and switches.

For normal server applications these baffles would be fitted either side of the front 19-inch mounting angles.

Where mixed technologies such as servers and switches need to be housed the baffles can be staggered creating two "L" shaped voids. Typically a baffle would be fitted on the front left hand side providing a cold air void along the front and right hand side of the cabinet. The hot air void would then comprise of the opposing "L" shaped void down the left hand side and rear of the cabinet.



Technical Specifications & Order Codes

Order Code	Description	Shipping Weight
ACVBPA428A	Access Cabinet Vertical Brush Strip Baffles To suite 42U x 800mm wide cabinet Finished Light Grey NCS 1502-Y	8.5kg
ACVBPA428B	Access Cabinet Vertical Brush Strip Baffles To suite 42U x 800mm wide cabinet Finished Black RAL9005	8.5kg
ACVBPA478A	Access Cabinet Vertical Brush Strip Baffles To suite 47U x 800mm wide cabinet Finished Light Grey NCS 1502-Y	9.5kg
ACVBPA478B	Access Cabinet Vertical Brush Strip Baffles To suite 47U x 800mm wide cabinet Finished Black RAL9005	9.5kg

Each set comprises of
2 x Vertical brush strip baffles, 2 x Pairs of handed mounting brackets, 1 x Fixing kit.

Scavenger Fan Units

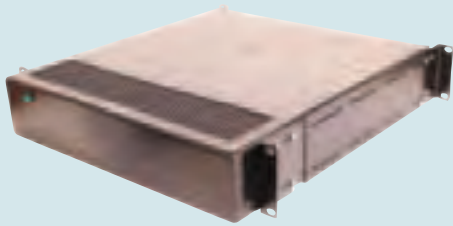

Scavenger Fan Tray

2U Scavenger Fan Tray

Developed to mount into the bottom 2U of the cabinet the scavenger fan tray has been designed to pull cold air from either the floor void or from the local ambient environment.

With the top perforated area of the fan tray protruding through the front 19-inch mounting angles the unit feeds air into a chimney created by a solid door, side panels, vertical baffles and equipment mounted in the cabinet. Any unused 19-inch apertures need to be blanked off to maximise cooling efficiency.

Ideal for scenarios where the air flow to the cabinet is restricted due to either;

- the remote location of the cabinet in relation to the CRAC unit (Computer Room Air Conditioning)
- where the velocity of the air from the CRAC unit is too high causing the air to bypass the cabinet location providing ineffective cold air feed

In such cases the scavenger unit is capable of greatly improving the air feed characteristics of the cabinet.

Technical Specifications

Height	2U (88.1mm)
Width	482.6mm Wide (over mounting lugs) 432.6mm Wide (over plenum chamber)
Depth	463.0mm
Protrusion Through 19-inch	100.0mm
Mounting Facility	EIA 310D 19-inch Compliant
Mounting Range	420.0mm Min 675.0mm Max
Unit Weight	8.1kg
Material	1.5mm mild steel
Finish	Painted Black RAL9005
Power Indicator	LED lit green when power is present
Lead Type	Supplied with IEC 320 (10amp) to UK 3-Pin (BS1363) lead
Warranty	12 Months
Compliance	WEEE Directive. RoHS Compliant CE Approved



Description	Electrical Supply	Order Code	Air Flow Characteristics
2U Scavenger Fan Tray Assembly	220v A/C 50Hz	RMHPFU230 RMHPFU120	675m ³ /Hour 695m ³ /Hour

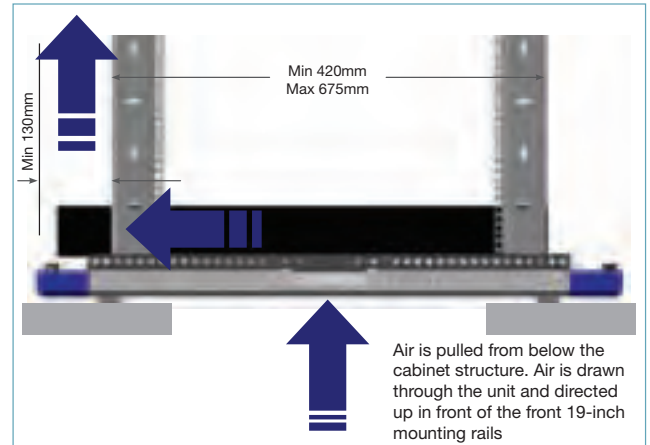
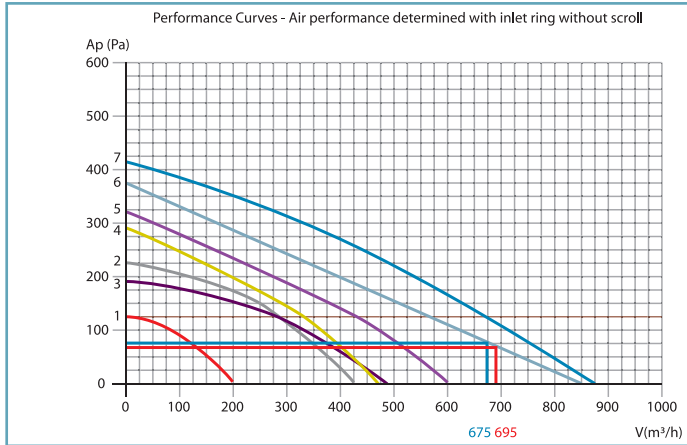

Rack Mounted Fan Units



In-Rack Ventilation Units

In-Rack Ventilation Units

Based on universal 19-inch mounting centres (IEC 297 standard), Cooper B-Line offer two sizes of In-Rack Ventilation Units. Both 3 and 6 fan versions share the same characteristics.

- Fits directly to panel mounts.
- Neon power indicator.
- Occupies only 1U of rack space.
- Front panel metalwork 3.0mm powder coated mild steel.
- Other metalwork 1.2mm powder coated mild steel.
- Fan specification - see page 63 for the roof mounted fan tray.

Description	No. of Fans	Order Code
Ventilation unit - 230v A/C	3	IVU3
Ventilation unit - 230v A/C	6	IVU6

Earth Kits & Earth Bars

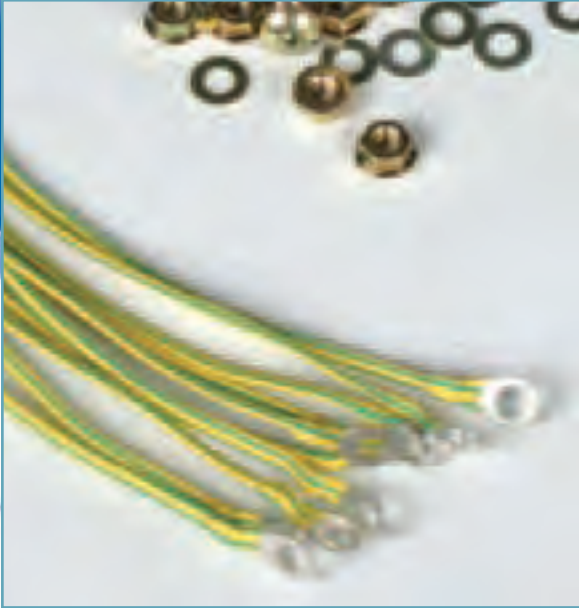

Cabinet Earthing Kits

An extensive range of earth kits and earth bars are available to cover our range of standard products. In addition we also offer a range of standard, non-cabinet specific, products that can be easily modified to fit most applications.

Earth kits are available for each of our standard products lines. Each kit comprises sufficient earth leads, nuts and screws to provide earth continuity through the product in compliance to EN60950 Clause 2.5.11.

Order Code	Description
------------	-------------

AEK	Access Cabinet Earth Kit.
-----	---------------------------



Earth Bars

Our earth bars are designed to mount either onto the vertical mounting angle or into the side of the cabinet. They offer an easy way of ensuring that all active equipment can be grounded and are ideal for augmented Cat6 applications.

Order Code	Description
------------	-------------

EB1	Pre-tapped Copper Earth Bar – 1m Length.
EB2	Pre-tapped Copper Earth Bar – 2m Length.
EBL20	Pack of 20 x Copper Earth Bar Clamps.
ECEBIM	Earth Bar Isolation Mounting Kit.

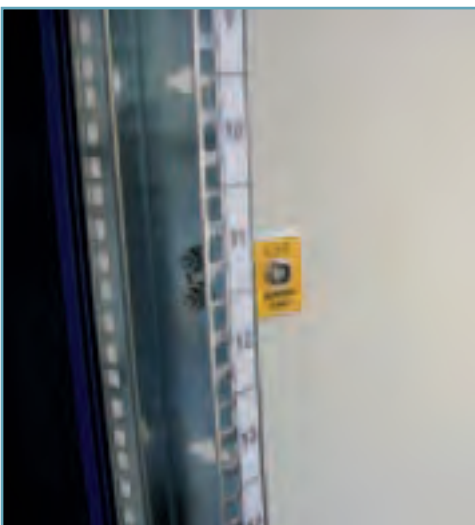

Static Earth Point

Comprising of a bracket and applicable fixings the Static Earth Point can be fixed to any suitable point on any of the standard Access 19-inch vertical rails (not 3 into 2 rail configurations). Finished in a zinc plate and clear passivate finish the Static Earth Point provides earthing continuity to the Access frame which in turn can be bonded down to any suitable clean earth point.

Order Code	Description
------------	-------------

AEB	Cabinet Electro Static Earthing Point
-----	---------------------------------------

Unit Height Labels

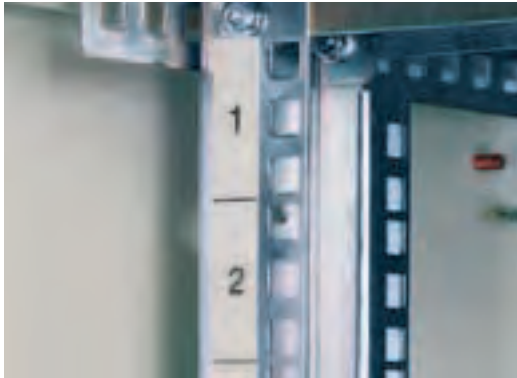

“U” Height Labels



“U” Height Labels



Bolt Through Kit

Unit Height Labels

One of the most difficult tasks when fitting equipment in 19-inch cabinets is locating the unit height position for mounting. Cooper B Line have solved this problem by supplying a self adhesive 'U' height numbering strip which simply fixes to the front face of the 19-inch panel mounts.

Technical Overview

- Pressure sensitive self adhesive.
- Universal size to suit all Access cabinets.
- Just trim to the desired unit height as required.
- Black lettering on white background.

Order Code	Description
AUHL	Pairs of height labels, 1-47 - Top to Bottom
AUHLR	Pairs of height labels, 1-47 - Bottom to Top
AUHLFR	Pairs of height labels, 1-47 & 48-94 - Top to Bottom
AUHLFRR	Pairs height labels, 1-47 & 48 - 94 - Bottom to Top

Bolt Through Kit

Access bolt through kits are the preferred method of baying suites of Access cabinets with side panels in situ. The kit consists of a set of two M8 x 70 screws, nuts and washers, finished in zinc plate and yellow passivate. Suitable for Access cabinets with pre-drilled extrusion, bolt through kits are available ex-stock.

Description	Order Code
Bolt Through Kit	BTK

Standard PDU



5 way horizontal



7 way horizontal



PDU surge



PDU switch

Standard Horizontal Power Management

Horizontal Mounting PDUs are fitted either to the front, rear or both 19-inch mounting rails

Benefits

- Suitable for horizontal applications
- Integral 19-inch mounting brackets
- Robust all aluminium housing
- Shrouded switch
- Unit overall rating 13A, 250V
- 3 metre input lead terminated with a BS1363 plug fused at 13A
- 2U of rack space is required for horizontal units when fitted to the front 19-inch mountings

Technical Data

Order Code	Description
PSH04DC21SN3DB	4 Way BS1363 Horizontal Mounting PDU - Switched 13 AMP
PSH05DC21SN3DB	5 Way BS1363 Horizontal Mounting PDU - Switched 13 AMP
PSH06DC21SN3DB	6 Way BS1363 Horizontal Mounting PDU - Switched 13 AMP
PSH04DR21SN3DB	4 Way BS1363 Horizontal Mounting PDU with sockets at 45 degrees - Switched 13 AMP
PSH05DR21SN3DB	5 Way BS1363 Horizontal Mounting PDU with sockets at 45 degrees - Switched 13 AMP
PSH04DC21SF3DB	4 Way BS1363 Horizontal Mounting PDU - Switched 13 AMP with 10KA surge protector
PSH05DC21SF3DB	5 Way BS1363 Horizontal Mounting PDU - Switched 13 AMP with 10KA surge protector
PSH06DC21SF3DB	6 Way BS1363 Horizontal Mounting PDU - Switched 13 AMP with 10KA surge protector
PSH04IC21NN3DB	4 Way IEC320 Horizontal Mounting PDU - Non switched 13 AMP
PSH06IC21NN3DB	6 Way IEC320 Horizontal Mounting PDU - Non switched 13 AMP
PSH08IC21NN3DB	8 Way IEC320 Horizontal Mounting PDU - Non switched 13 AMP

- Please note that the standard PDUs above have a switched input with a cable length of 3m.
- If you have any PDU requirements in addition to the ones shown above, please contact our customer services team who will be happy to arrange a quotation.



13 amp switched 10 way

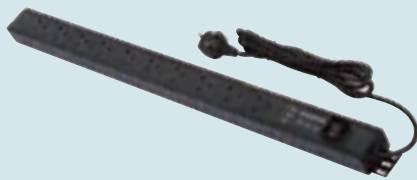

13 amp switched 10 way with surge protection



13 amp 10 way IEC sockets



13 amp 10 way IEC sockets with surge protection



32 amp switched 10 way 450 sockets

Standard Vertical Power Management

Suitable for vertical mounting either direct to the 19-inch mounting angles or to vertical cable tray

Benefits

- Robust all aluminium housing
- Shrouded switch
- Unit overall rating 13A, 250V
- 3 metre input lead terminated with a BS1363 plug fused at 13A

Technical Data

Order Code	Description
PSV06DR21SN3DB	6 Way BS1363 Vertical Mounting PDU with socket at 45 degrees - Switched 13 AMP
PSV08DR21SN3DB	8 Way BS1363 Vertical Mounting PDU with socket at 45 degrees - Switched 13 AMP
PSV10DR21SN3DB	10 Way BS1363 Vertical Mounting PDU with socket at 45 degrees - Switched 13 AMP
PSV12DR21SN3DB	12 Way BS1363 Vertical Mounting PDU with socket at 45 degrees - Switched 13 AMP
PSV08DR21SF3DB	8 Way BS1363 Vertical Mounting PDU with sockets at 45 degrees - Switched 13 AMP with 10KA surge protector
PSV10DR21SF3DB	10 Way BS1363 Vertical Mounting PDU with sockets at 45 degrees - Switched 13 AMP with 10KA surge protector
PSV12DR21SF3DB	12 Way BS1363 Vertical Mounting PDU with sockets at 45 degrees - Switched 13 AMP with 10KA surge protector
PSV10IC21SN3DB	10 Way IEC320 Vertical Mounting PDU - Non switched 13 AMP
PSV12IC21SN3DB	12 Way IEC320 Vertical Mounting PDU - Non switched 13 AMP
PSV20IC21SN3DB	12 Way IEC320 Vertical Mounting PDU - Non switched 13 AMP

- Please note that the standard PDUs above have a switched input with a cable length of 3m.
- If you have any PDU requirements in addition to the ones shown above, please contact our customer services team who will be happy to arrange a quotation.

Standard PDU Cont.

Configured Power Management Options

A selection of commonly configured PDUs

- Vertical & Horizontal Options
- Switched versions provided with hinged switch cover to prevent accidental switching



Technical Data

Order Code	Description
PCH04DC21SN3DM	PDU Horizontal Mounting UK 4-Way 13 AMP 1U High - Switched
PCH05DC21SN3DM	PDU Horizontal Mounting UK 5-Way 13 AMP 1U High - Switched
PCH06DC21SN3DM	PDU Horizontal Mounting UK 6-Way 13 AMP 1U High - Switched
PCV04DC21SN3DM	PDU Vertical Mounting UK 4-Way 13 AMP - Switched
PCV05DC21SN3DM	PDU Vertical Mounting UK 5-Way 13 AMP - Switched
PCV06DC21SN3DM	PDU Vertical Mounting UK 6-Way 13 AMP - Switched
PCV08DC21SN3DM	PDU Vertical Mounting UK 8-Way 13 AMP - Switched
PCV10DC21SN3DM	PDU Vertical Mounting UK 10-Way 13 AMP - Switched
PCV12DC21SN3DM	PDU Vertical Mounting UK 12-Way 13 AMP - Switched
PCH04SC21SN3SM	PDU Horizontal Mounting EU 4-Way Schuko - Switched
PCH05SC21SN3SM	PDU Horizontal Mounting EU 5-Way Schuko - Switched
PCH06SC21SN3SM	PDU Horizontal Mounting EU 6-Way Schuko - Switched
PCV04SC21SN3SM	PDU Vertical Mounting EU 4-Way Schuko - Switched
PCV05SC21SN3SM	PDU Vertical Mounting EU 5-Way Schuko - Switched
PCV06SC21SN3SM	PDU Vertical Mounting EU 6-Way Schuko - Switched
PCV08SC21SN3SM	PDU Vertical Mounting EU 8-Way Schuko - Switched
PCV10SC21SN3SM	PDU Vertical Mounting EU 10-Way Schuko - Switched
PCV12SC21SN3SM	PDU Vertical Mounting EU 12-Way Schuko - Switched
PCV08IC21SN3DM	PDU Vertical Mounting 8-Way IEC - Switched
PCV10IC21SN3DM	PDU Vertical Mounting 10-Way IEC - Switched
PCV12IC21SN3DM	PDU Vertical Mounting 12-Way IEC - Switched
PCH06IC21SN3DM	PDU Horizontal Mounting 6-Way IEC - Switched
PCH08IC21SN3DM	PDU Horizontal Mounting 8-Way IEC - Switched
PCH10IC21SN3DM	PDU Horizontal Mounting 10-Way IEC - Switched

- If you have any PDU requirements in addition to the ones shown above, please contact our customer services team who will be happy to arrange a quotation.

Technical Data

Order Code	Description
PDUMTGBRKT	Standard PDU Mounting Bracket Kit

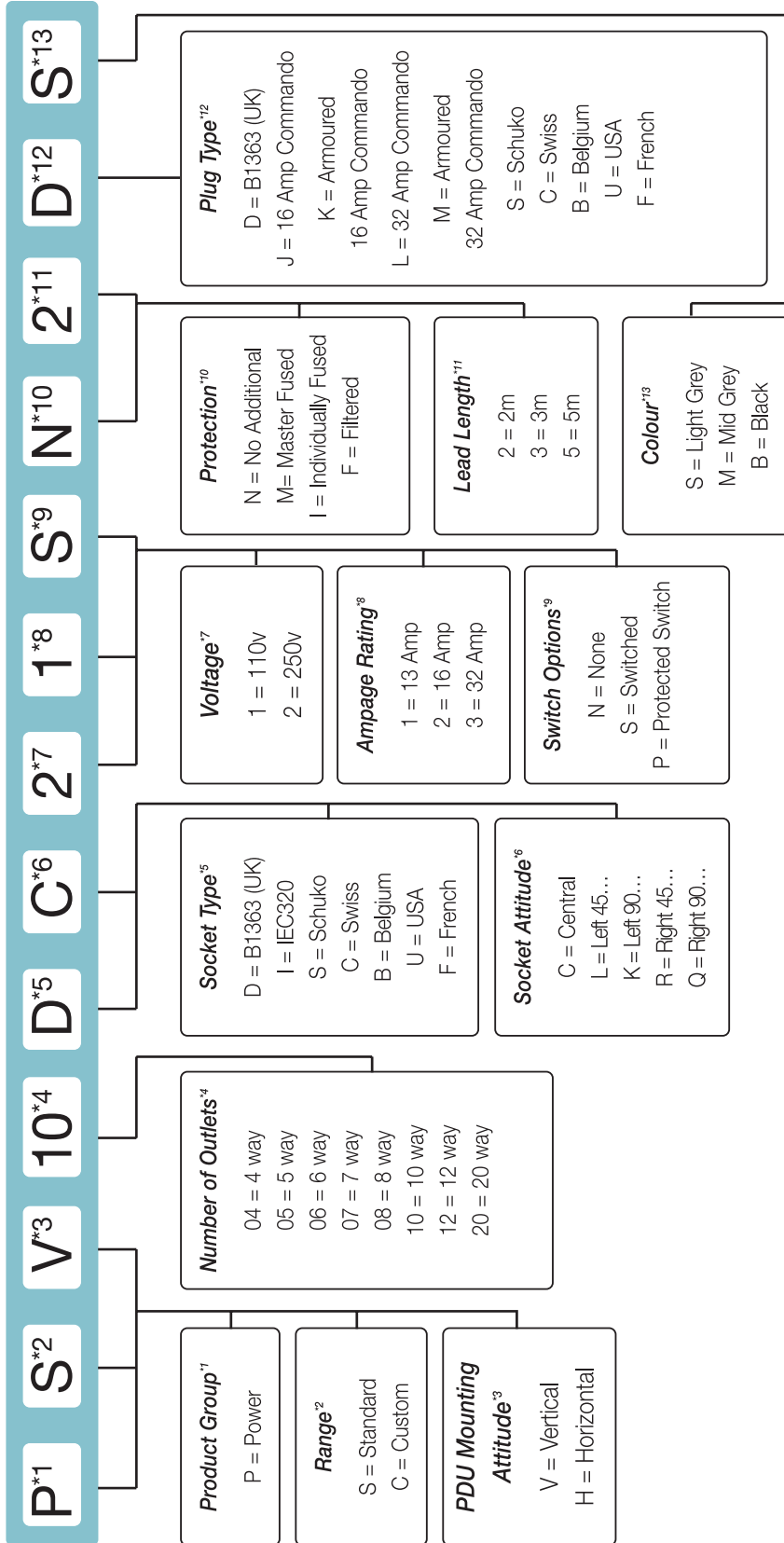

Stand Alone Intelligent PDUs



Overview

Forming a new part of Cooper B-Line's intelligent Power And Distribution solution comes our AMz Switched Series of stand alone vertically mounted intelligent Power Distribution Units (PDUs). These units are available in a range of configurations to suit most popular applications with various current load, socket and connection options.

Connected via a standard TCP/IP network, individual units can be remotely accessed to view both real time and historical data. Each unit offers the added benefit of remote switching, allowing both individual or grouped outlets to be switched on or off via a user and password protected web browser interface. In the event of an outlet's status changing, and for added security, the system can be configured to automatically generate an e-mail or SNMP trap to notify one or more system administrators of a power status change. The e-mail function incorporates a simple report detailing the unit's location (name), an overview of the outlet status together with a time and date stamp for traceability.

- Real time monitoring of the power status of each PDU through a standard TCP/IP network.
- Remote switching of individual or grouped outlets.
- Bundled software allowing up to 255 PDUs to be monitored concurrently.
- Configurable automated alert manager.
- Real time and historical power consumption log viewed by individual PDU.
- Customer configurable alarm thresholds.
- Local status indication via LED panel and individual outlet LED indicators.
- Easy to use.

Technical Specifications

Connectivity	RJ45 for ETHERNET
Operational Frequency	47~63 HZ full range
LED Indicator	Yellow LED - Current Meter Red LED - IP Address
Integrated Meter	3 Digits. Warning and Overload - Meter will flash once in 1 second. Range - 0 A ~ 20 A (True RMS) Resolution - 0 A ~ 20A: 0.1A Precision - 0A~20A: +/- 2%/±0.1AMP
Audible Alarm	Warning - 1 beep in 1 second Overload - 3 beeps in 1 second Circuit breaker triggered - Continuous beep
Operational Temperature	-5 ~ 45 °C
Operational Humidity	0% ~ 95%
Storage Temperature	-25 ~ 65 °Cv
Software Platform	Management Software Included



Features

1	Ethernet Port	The Network connection for the built-in web server supporting 10M.
2	Audible Alarm	1. Warning - 1 beep in 1 second. 2. Overload - 3 beeps in 1 second Note: The audible alarm will continue to sound until either the unit's current draw drops below the threshold limit or falls to less than 0.5amp over the PDUs maximum rating.
3	Function Button	1. Press and release to turn off the warning beeps. The overload beeping can not be cancelled. 2. Press and hold the key after 2 beeps and the meter display will show the unit's allocated IP address. 3. Press and hold the key after 6 beeps to reset the unit's Ethernet connection and recycles the power, resetting all the outlets.
4	LED Display	Displays the unit's power consumption or the unit's IP address.
5	LLED Indication	Current Light on indicates the power consumption with the True RMS current meter. IP Address Light on shows the unit's IP address.
6	Circuit Breaker	Provides circuit protection in the event of a current over draw.
7	Output Outlet	Various types and numbers of outlets. Please check the specification for detailed information.
8	Output LED	LED indicator for output power.

Stocked Models

Order Code	Outlets	Capacity	Input	Output	Protection
AMz-1023-SW-08-1L	8 ports	10A	IEC C14p	IEC C13r	1CB
AMz-1023-SW16C131L	16 ports	10A	IEC C14p	IEC C13r	1CB
AMz-1623-SW-24-1L	24 ports	16A	IEC C20p	IEC (21)C13r (3)C19r	1CB
AMz-1623-SW-24-1CL	24 ports	16A	IEC 309p	IEC (21)C13r (3)C19r	1CB
AMz-3223-SW-24-3L	24 ports	32A	IEC 309p	IEC (21)C13r (3)C19r	3CB

I-Pal & I-Box System



Introduction

Today's businesses are becoming more and more reliant on their IT infrastructure to sustain a competitive edge. Businesses are therefore looking to maximise their capital investments in IT systems by striving to achieve 100% network availability.

"Human Error" remains the largest threat to network integrity. Something as simple as incorrect or unauthorised modification to cable patching can cause systems to fail resulting in lost time and lost revenues. The first line of defence is therefore the proactive control of who has access to the infrastructure and when!

Whilst building control systems have been developed to manage room access, historically cabinet level security has been managed with conventional barrel key locks. On larger sites this has required the adoption of complex and time-consuming systems to manage the authorisation of personnel and the issuing of keys. Even with these elaborate processes in place the risk from the loss of keys, not to mention the potential expense and trouble of changing locks, can make access control an expensive hidden cost.

In response to demand from our customers Cooper B-Line has developed i-PAL, an intelligent electronic proximity and control solution. Based on proven building control architecture i-PAL can deliver either simple configurable local access and control or, when integrated with i-BOX, a fully scalable local and remote access control and monitoring solution with access tracking and alarm function. In addition the adoption of i-BOX has the added benefit of, fully configurable environmental monitoring solution with a range of SMART sensors complete with individually configurable threshold alarms.



Control & Monitoring

Integrated Proximity Access Locking Handle

i-PAL offers a simple modular solution to cabinet access control utilising leading edge proximity card technology. Fully compatible with the Access Cabinet range i-PAL can be supplied as either a factory or retrofit option.

As a stand alone solution i-PAL can be configured in a matter of minutes to provide configurable access control;

- Step 1** Simply plug the i-PAL handle (IPALBL, IPALBK, IPALGY) into its multi regional universal power supply (IBIPPSU).
- Step 2** Then using the system administrator program card you can program in up to 500 user cards per handle. (IPALCARD contains one system administrator programme card together with three user and user delete cards - additional user cards are available IPALACARD).
- Step 3** Add or delete user cards using the system administrator programme card as required.

i-PAL can also be designed into other bespoke applications and is compatible with a number of other cabinet products. i-PAL is designed for indoor applications although other handles offering the same functionality are available for outdoor applications, please contact us for details.



Key Features

- ✓ Proactive Control
- ✓ Local Management
- ✓ Easy Configuration
- ✓ Scaleable
- ✓ Retrofit-able
- ✓ Upgradeable



+



+

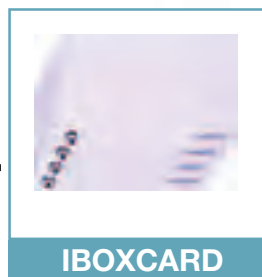

=

**ACCESS
CONTROL**

Technical Details

Dimensions Handle assembly:	30mm Wide x 20mm Deep x 154mm High
Dimensions I-PAL module:	34mm Wide x 36mm Deep x 85mm High
Voltage:	12VDC
Power:	0.72W
Current:	60ma @ 12VDC
Communications Port:	RS232
Standalone operation:	500 Card Capacity
	<i>When Connected to i-BOX, see i-BOX details</i>

Component Part Codes

Order Code Description

IPALBL	Single i-PAL Handle Blue
IPALBK	Single i-PAL Handle Black
IPALGY	Single i-PAL Handle Grey
IPALEXTL	i-PAL Handle 5 metre Extension Lead
IBIPPSU	i-BOX/i-PAL Universal Power Supply
IPALCARD	i-PAL Card set comprising of 1x program card, 3x user cards and 3x user delete cards
IPALACARD	i-PAL Additional card set comprising of 5x user cards and 5x user delete cards
	*Note lock ods/lock cam may require modification to operate correctly



IPALBL



IPALBK



IPALGY



Solution

Integration With i-BOX

By simply integrating i-PAL with i-BOX the i-PAL becomes a fully scaleable local and remote access control system with full system administrator override facility providing ultimate access control. Additional enhanced functions include;

- Integrated centralised user card management database allowing individual user cards to be added, deleted or modified in a matter of seconds. Any changes to the database trigger automatic updates to all the associated access points (handles) providing real time seamless security.
- An increased user capacity from 500 users per access points (stand alone i-PAL) to 4,000 users per access point.
- Real time transaction logging including event date/time stamp for each access point transaction or attempted transaction.
- The ability to generate detailed reports with the option to filter the data in a wide variety of ways including by an individual access point, group of access points, employee name, company / department, individual date or date range. The system also allows this data to be exported should the information need to be presented in an alternative format or need further analysis.
- The ability to define and associate up to 256 configurable user times zones. These time zones can then be associated to individual cards providing authorised access periods (i.e. 08:00 to 18:00 Monday to Friday access is granted).
- IP camera integration allowing individual access points to be associated with local cameras providing the opportunity to link video or photographic data to all logged transaction events.
- The option to link unauthorised/exceptional access transactions to SMS or e-mail alerts providing real time security alarms.

Importantly the loss of the network does not mean loss of security as the handle holds the card access data and simply uploads authorised transaction data to the i-BOX database when the network and i-BOX come back on line. Each i-BOX is configured to support the integration of up to two i-PAL handles.

i-PAL Enhanced Features

- ✓ Simple Key Replacement
- ✓ Support for 4,000 Users
- ✓ Transaction Logging
- ✓ Time Zone Configuration
- ✓ Plug and Play
- ✓ GUI Management Interface
- ✓ IP Camera Link
- ✓ Online for:-
Real Time Alarm Reporting; SMS, Email, SNMP Traps



i-BOX

Solution

Environmental Monitoring

As well as offering the integration of an enterprise level Access Control and Security system i-BOX has the added benefit of providing a comprehensive Environmental monitoring solution, allowing for the convergence of Facilities / IT monitoring within a single network addressable unit. Built into i-BOX as standard are four environmental sensors, these being;

- Temperature.
- Humidity.
- Light.
- Consumed voltage.

The further fourteen SMART ports on the front of the i-BOX allow a whole range of optional plug and play sensors to be connected, details of these sensors are shown on the preceding pages. In each case the individual sensor provides;

- Individual sensors can be linked up to 15m away from the i-BOX using the sensor extension cables (IBOXSEC).
- The ability to set individual sensor level threshold limits with pre alarm and full alarm functionality triggering alarm outputs via inbuilt SNMP (Small Network Management Protocol) agents including V2c.
- In most cases sensors have the function to provide Low , Pre, and High threshold alarms with the added function of being able to set Quick Change alarms identifying potential problems when they first occur.
- Threshold alarms can be set to be temporarily disabled in instances when the cabinet door or side panels are opened altering the microenvironment within the cabinet.
- The facility to link alarm functions with external "calls to action" including SMS and e-mail alerts, essential for lights out or unmanned facilities.
- Configurable sensor level identification enabling quick and easy identification of the item in alarm.
- Full plug and play functionality providing easy intuitive configuration.
- Built in network and sensor test wizards to ensure optimum system operation.

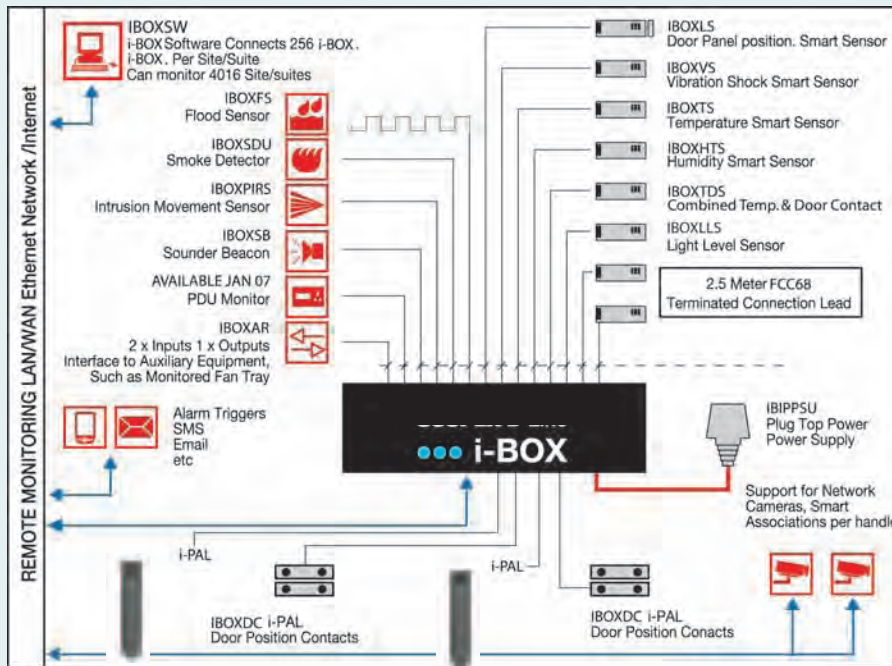

Other features of the system include;

- Support for up to 65,000 users per network system.
- The ability to manage up to 256 i-BOX units using one network PC providing the ability to control, monitor and manage up to;
- 512 x i-PAL access points.
- 1,024 x Integrated temperature, humidity, light and consumed voltage sensors.
- 3,584 x Additional fully configurable sensors.
- Native Ethernet TCP/IP, UDP 10Mb communications.
- Local and Wide Area Network (LAN / WAN) support.
- CCTV integration connecting up to two cameras to one i-BOX.
- Simple integration to either cabinet level or room level fire alarm systems.
- ActiveX Software Development Kit (SDK) for full integration to third party applications.
- Card management and configuration facility with the ability to generate user cards including photo ID.
- Multi language support.

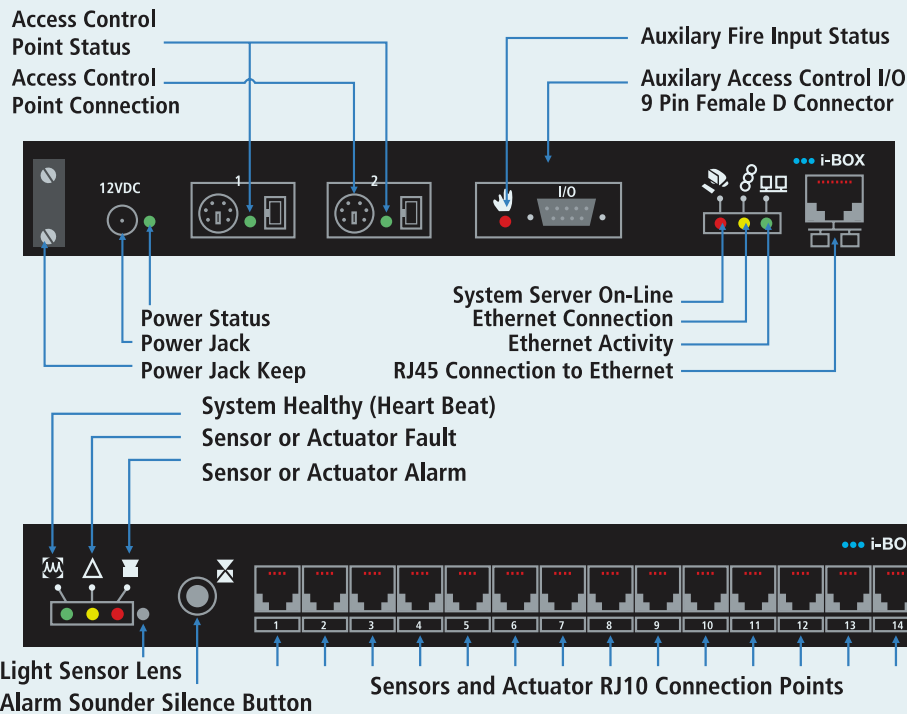

i-BOX Part Code And Technical Specification

IBOX

The i-BOX unit is an ethernet controller that plugs directly into the IP network.

- The unit is powered by a single IBIPPSU.
- The IBOX has a single temperature, humidity, light level and incoming voltage sensor built into the unit.
 - Voltage Sensor: Incoming voltage sensor, sampling 10Bit
 - Humidity 0-100%, 0.5% Resolution, 3% Accuracy,
 - Temperature Range -25°C to 123.8°C, Accuracy .04°C @ 25°C to 40°C
 - Aspirating Fan: 5.2 cfm
 - Light Level Sensor: 0 to 200 Lux

Controller and sensor connections

- 2 x IPAL Cabinet Handle, or Standard Access Control Doors via 6 way Mini Din Plug
- 2 x IBOXDC, Door Position Sensor, Mini Din through connector
- An additional 14 external devices and sensors can be plugged into the i-BOX via 4 way FCC68 connectors
- 1 x 9 way D Type for addition set firmware I/O, default fire interface plus 9 x Status LEDs

Unit Size And Operating Environment

- Dimensions 212mm wide x 95mm deep x 29mm high
- Universal Fixing Bracket 25 x 25mm
- Voltage: 12VDC (48VDC option)
- Current: 210ma @ 12VDC
- Steel Enclosure: Finish Powder Coated Grey TEX36
- Operating Environment -25°C to 85°C
- Power: 2.52 Watts

Communication Protocols

- Communications Port: RJ45 Ethernet
- Card Holder: 4,000 capacity local storage expandable to 32,000
- Standard Memory: 5,000 transaction local storage expandable to 32,000
- Protocol: TCP/IP, UDP and ARP
- Supporting: LAN/WAN & VPN

i-BOX USER CARDS

Order Code Description

- IBOXCARD i-BOX User Cards
- Pack of 10 Programmable User Cards



Order Code Description

- IBOXFOB i-BOX User Fobs
- Pack of 10 Programmable User Fobs



Order Code Description

- IBOXAPL i-BOX User Self Adhesive Labels
- Pack of 10 Programmable Self Adhesive Labels

Optional i-BOX Sensors

Order Code Description

SMART Temperature Sensor

- With 2.5 metre terminated lead with 4 way FCC68 jack.
- Set high low temperature fresh hold alarm and ambient temp on demand.
Associate Door Contact for door left open alarm etc
- Door Contact Read range 15mm from side 10mm from front
- 1 x Status LED
- Temperature: -10 to 75c Accuracy 4%
- Dimensions: 20mm high x 60mm long x 20mm wide
- Powered by i-BOX
- Power: 15ma



Door Position Contacts

- With 2.5 metre terminated lead with mini din through jack. For associated iBOX only. Read range 15mm from side 10mm from front
- 1 x Status LED
- Dimensions: 20mm high x 60mm long x 20mm wide
- Powered by i-BOX
- Power: 8ma



SMART Location Contacts

- With 2.5 metre terminated lead with 4 way FCC68 jack. For Side Panel open/closed, and equipment location monitoring.
- Read range 15mm from side 10mm from front
- 1 x Status LED
- Dimensions: 20mm high x 60mm long x 20mm wide
- Powered by i-BOX
- Power: 12ma



Combined Temperature And Contact Sensor

- With 2.5 metre terminated lead with 4 way FCC68 jack.
- Set high low temperature fresh hold alarm and ambient temp on demand
- 1 x Status LED
- Temperature: -10°C to 75°C Accuracy 4%
- Dimensions: 20mm high x 60mm long x 20mm wide
- Powered by i-BOX
- Power: 12ma



SMART Temperature And Humidity Sensor

- With 2.5 metre terminated lead with 4 way FCC68 jack.
- Set high low temperature fresh hold alarm and ambient temp on demand
- 1 x Status LED
- Humidity 0-100%, 0.5% Resolution, 3% Accuracy
- Temperature: -25°C to 123.8°C Resolution 0.04°C @ 25 to 40°C
- Powered from i-BOX
- Power: 16ma



Smart Light Level Sensor

- With 2.5 metre terminated lead with 4 way FCC68 jack. Designed for darkened environments, high level light and colour responsive sensors available on request.
- 1 x Status LED
- Light Level Response: 0 To 200 Lux
- Dimensions: 20mm high x 60mm long x 20mm wide
- Powered from i-BOX
- Power: 15ma



Optional i-BOX Sensors (continued...)

Order Code Description

IBOXVS Smart Intrusion Vibration Vandalism Sensor

- With 2.5 metre terminated lead with 4 way FCC68 jack.
- 1 x Status LED
- Vibration fresh hold from 0-100 SPM
- Dimensions: 20mm high x 60mm long x 20mm wide
- Powered from i-BOX
- Power: 12ma



IBOXAR Auxiliary Relay and 2 x Digital Inputs

- With 2.5 metre terminated lead with 4 way FCC68 jack.
- 1 x Status LED
- Face Plate single gang electrical box size: 85mm square 13mm deep
- Back Box: 110mm high x 86mm wide x 28mm deep
- Relay rated: 48VDC @ 5amp
- Digital Inputs: Normally open or closed voltage free contacts
- Powered by i-BOX
- Power: 28ma quiescent 52ma alarm

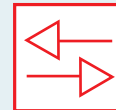

IBOXFS SMART Flood Sensor

- With 2.5 metre terminated lead with 4 way.
- FCC68 jack, 5 Meters Flood cable, supplied with 15 Fixing clips.
- 2 x quick blow fuses for electrical safety
- Flood scale 40-170 using sensitive wicking cable
- 1 x Status LED
- Face Plate single gang electrical box size: 85mm square 13mm deep
- Back Box: 110mm high x 86mm wide x 28mm deep
- Voltage: 12v
- Power: 50ma



IIBOXPIRS Intrusion 360 Passive Infra Red Movement Sensor

- With 2.5 metre terminated lead with 4 way FCC68 jack
- 1 x Status LED, Multizone PIR
- Area covered 7M x 6M @ a mounting height of 2.5M
- Dimensions: 26mm high x 60mm long x 20mm Wide
- Powered by i-BOX
- Power: 15ma



IBOXSB Sounder Beacon Unit

- With 2.5 metre terminated lead with 4 way FCC68 jack.
- 4 x Red Flashing High Intensity Miniature bulbs flash at frequency of approximately 3Hz
- Sound Output: 100dB @ 1M
- Alarm Frequency 3.5-4.5KHz
- Dimensions: 45mm deep x 122mm long x 73mm wide
- Voltage: Powered By i-Box
- Power: 200ma



IBOXSDU i-Box Smoke Detector Unit

- With 2.5 metre terminated lead with 4 way FCC68 jack.
- Combined optical smoke detector with rate of risen and fixed temperature heat
- 1 x Status LED
- Temperature: -10°C to 75°C Accuracy 4%
- Smoke response to EN54 Part 7 Heat Response 60°C
- Dimensions: 105mm diameter x 60mm deep
- Powered by i-BOX
- Power: 15ma quiescent 30ma in alarm



IBOXSEC 2.5m Sensor Extension Cable Terminated Lead

- With 4 way FCC68 with jack and socket

IBOXSMBK Sensor Mounting Bracket

- Single bracket supplied complete with fixings

Sensors (continued...)

Order Code Description

IBOXMFTL

Monitored Fan Tray Lead

- 2.5 metre terminated lead with 4 way FCC68 jack, connection with 2 x Molynx 3 pin connectors on flying lead for connection to fan tray.
- 1 x Status LED
- Dimensions: 20mm high x 60mm long x 20mm wide
- Digital Inputs: Normally open or closed dry contacts
- Powered by i-BOX
- Power: 12ma

i-BOX User Interface

Order Code Description

IBOXSW

i-BOX Software

- Manages 65,000 card holders and access level group with 256 time zones per system
- Built in alarm reporting, Photo ID, Who's in/out, Configuration/User wizards for true Plug and Play operation
- CCTV Network Camera Support per Door
- Software using SQL Standard Query Language
- Protocol: TCP/IP, UDP and ARP
- Alarm Handling: SMS, Email & SNMP Traps version 2.1c
- SDK option for Integration to 3rd Party Applications, with support for up to 4016 systems
- Minimum PC specification, Pentium Processor, 64Mb RAM, 64Mb Video Memory for 800 x 600 resolution, 200Mb of free harddisk space 100 BaseT ethernet connection, Mouse, Keyboard
- Designed for Microsoft® Windows XP™



Access Cabinet i-PAL & i-BOX Options

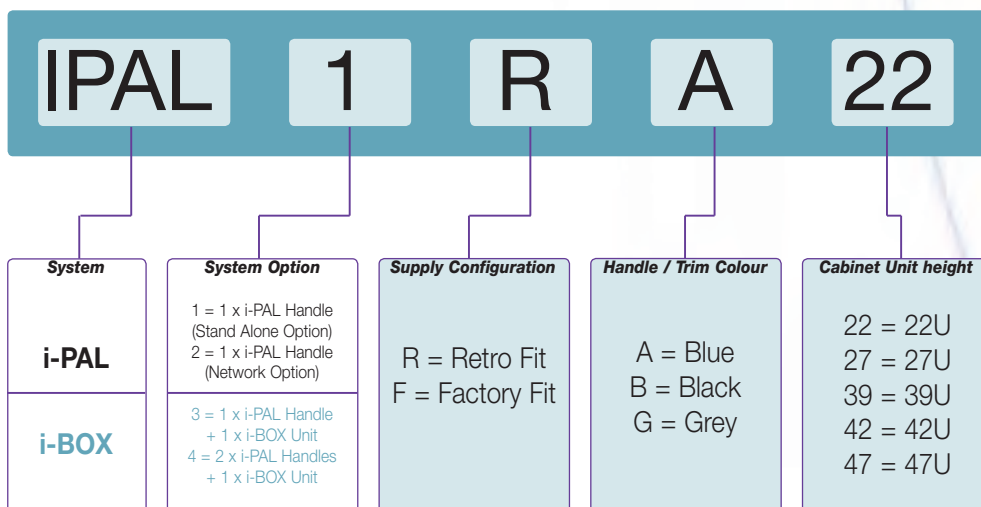

Access Cabinet - i-PAL Programmable Electronic Locking System

Each kit comprises the following supplied boxed and labelled;

- 1 x Colour Specific i-PAL Handle.
- 1 x Bottom Locking Rod (Unit Height Specific).
- 1 x Electronic Lock Rod Extension.
- 1 x Rod Coupling.
- 1 x Cable Duct (Universal Width - Trim To Size).
- 1 x Universal Power Supply.
- 10 x Self Adhesive cable clips.
- 1 x Programme Card
- 2 x User Cards
- 2 x User Delete Cards
- 1 x Set of fitting instructions.
- 1 x Glazed Door Top Trim Strip - Colour Specific (Trim To Size If Required).

Customer Retro Fit Kit.		Factory Fitted	
Order Code	Description	Order Code	Description
IPAL 1 R A 22	Blue	IPAL 1 F A 22	Blue
IPAL 1 R A 27	Blue	IPAL 1 F A 27	Blue
IPAL 1 R A 32	Blue	IPAL 1 F A 32	Blue
IPAL 1 R A 39	Blue	IPAL 1 F A 39	Blue
IPAL 1 R A 42	Blue	IPAL 1 F A 42	Blue
IPAL 1 R A 47	Blue	IPAL 1 F A 47	Blue
IPAL 1 R B 22	Black	IPAL 1 F B 22	Black
IPAL 1 R B 27	Black	IPAL 1 F B 27	Black
IPAL 1 R B 32	Black	IPAL 1 F B 32	Black
IPAL 1 R B 39	Black	IPAL 1 F B 39	Black
IPAL 1 R B 42	Black	IPAL 1 F B 42	Black
IPAL 1 R B 47	Black	IPAL 1 F B 47	Black
IPAL 1 R G 22	Grey	IPAL 1 F G 22	Grey
IPAL 1 R G 27	Grey	IPAL 1 F G 27	Grey
IPAL 1 R G 32	Grey	IPAL 1 F G 32	Grey
IPAL 1 R G 39	Grey	IPAL 1 F G 39	Grey
IPAL 1 R G 42	Grey	IPAL 1 F G 42	Grey
IPAL 1 R G 47	Grey	IPAL 1 F G 47	Grey

Access Cabinet - i-PAL Programmable Electronic Locking System

Each kit comprises the following supplied boxed and labelled;

- 1 x Colour Specific i-PAL Handle.
- 1 x Bottom Locking Rod (Unit Height Specific).
- 1 x Electronic Lock Rod Extension.
- 1 x Rod Coupling.
- 10 x Self Adhesive cable clips.
- 1 x Glazed Door Top Trim Strip - Colour Specific (Trim To Size If Required).
- No Power Supply Unit
- 1 x Cable Duct (Universal Width - Trim To Size).

- This option would be used where the handle will be plugged into an existing i-BOX installation

Order Code	Description	Order Code	Description
IPAL 2 R A 22	Blue	IPAL 2 F A 22	Blue
IPAL 2 R A 27	Blue	IPAL 2 F A 27	Blue
IPAL 2 R A 32	Blue	IPAL 2 F A 32	Blue
IPAL 2 R A 39	Blue	IPAL 2 F A 39	Blue
IPAL 2 R A 42	Blue	IPAL 2 F A 42	Blue
IPAL 2 R A 47	Blue	IPAL 2 F A 47	Blue
IPAL 2 R B 22	Black	IPAL 2 F B 22	Black
IPAL 2 R B 27	Black	IPAL 2 F B 27	Black
IPAL 2 R B 32	Black	IPAL 2 F B 32	Black
IPAL 2 R B 39	Black	IPAL 2 F B 39	Black
IPAL 2 R B 42	Black	IPAL 2 F B 42	Black
IPAL 2 R B 47	Black	IPAL 2 F B 47	Black
IPAL 2 R G 22	Grey	IPAL 2 F G 22	Grey
IPAL 2 R G 27	Grey	IPAL 2 F G 27	Grey
IPAL 2 R G 32	Grey	IPAL 2 F G 32	Grey
IPAL 2 R G 39	Grey	IPAL 2 F G 39	Grey
IPAL 2 R G 42	Grey	IPAL 2 F G 42	Grey
IPAL 2 R G 47	Grey	IPAL 2 F G 47	Grey

Access Cabinet - i-BOX Control & Monitoring System

Each kit comprises the following supplied boxed and labelled;

- 2 x Colour Specific i-BOX Handles.
- 2 x Bottom Locking Rods (Unit Height Specific).
- 2 x Electronic Lock Rod Extensions.
- 2 x Rod Couplings.
- 2 x Cable Ducts (Universal Width - Trim To Size).
- 1 x Universal Power Supply.
- 20 x Self Adhesive cable clips.
- 10 x User Cards
- 1 x i-BOX Unit.
- 1 x AX Series User Interface Software
- 1 x Set of instructions.
- 2 x Glazed Door Top Trim Strip - Colour Specific (Trim To Size If Required).

Customer Retro Fit Kit.		Factory Fitted Upgrade	
Order Code	Description	Order Code	Description
IBOX 4 R A 22	Blue	IBOX 4 F A 22	Blue
IBOX 4 R A 27	Blue	IBOX 4 F A 27	Blue
IBOX 4 R A 32	Blue	IBOX 4 F A 32	Blue
IBOX 4 R A 39	Blue	IBOX 4 F A 39	Blue
IBOX 4 R A 42	Blue	IBOX 4 F A 42	Blue
IBOX 4 R A 47	Blue	IBOX 4 F A 47	Blue
IBOX 4 R B 22	Black	IBOX 4 F B 22	Black
IBOX 4 R B 27	Black	IBOX 4 F B 27	Black
IBOX 4 R B 32	Black	IBOX 4 F B 32	Black
IBOX 4 R B 39	Black	IBOX 4 F B 39	Black
IBOX 4 R B 42	Black	IBOX 4 F B 42	Black
IBOX 4 R B 47	Black	IBOX 4 F B 47	Black
IBOX 4 R G 22	Grey	IBOX 4 F G 22	Grey
IBOX 4 R G 27	Grey	IBOX 4 F G 27	Grey
IBOX 4 R G 32	Grey	IBOX 4 F G 32	Grey
IBOX 4 R G 39	Grey	IBOX 4 F G 39	Grey
IBOX 4 R G 42	Grey	IBOX 4 F G 42	Grey
IBOX 4 R G 47	Grey	IBOX 4 F G 47	Grey

Access Cabinet - i-BOX Control & Monitoring System

Each kit comprises the following supplied boxed and labelled;

- 1 x Colour Specific i-BOX Handle.
- 1 x Bottom Locking Rod (Unit Height Specific).
- 1 x Electronic Lock Rod Extension.
- 1 x Rod Coupling.
- 1 x Cable Duct (Universal Width - Trim To Size).
- 1 x Universal Power Supply.
- 10 x Self Adhesive cable clips.
- 5 x User Cards
- 1 x i-BOX Unit.
- 1 x AX Series User Interface Software
- 1 x Set of instructions.
- 1 x Glazed Door Top Trim Strip - Colour Specific (Trim To Size If Required).

Order Code	Description	Order Code	Description
IBOX 3 R A 22	Blue	IBOX 3 F A 22	Blue
IBOX 3 R A 27	Blue	IBOX 3 F A 27	Blue
IBOX 3 R A 32	Blue	IBOX 3 F A 32	Blue
IBOX 3 R A 39	Blue	IBOX 3 F A 39	Blue
IBOX 3 R A 42	Blue	IBOX 3 F A 42	Blue
IBOX 3 R A 47	Blue	IBOX 3 F A 47	Blue
IBOX 3 R B 22	Black	IBOX 3 F B 22	Black
IBOX 3 R B 27	Black	IBOX 3 F B 27	Black
IBOX 3 R B 32	Black	IBOX 3 F B 32	Black
IBOX 3 R B 39	Black	IBOX 3 F B 39	Black
IBOX 3 R B 42	Black	IBOX 3 F B 42	Black
IBOX 3 R B 47	Black	IBOX 3 F B 47	Black
IBOX 3 R G 22	Grey	IBOX 3 F G 22	Grey
IBOX 3 R G 27	Grey	IBOX 3 F G 27	Grey
IBOX 3 R G 32	Grey	IBOX 3 F G 32	Grey
IBOX 3 R G 39	Grey	IBOX 3 F G 39	Grey
IBOX 3 R G 42	Grey	IBOX 3 F G 42	Grey
IBOX 3 R G 47	Grey	IBOX 3 F G 47	Grey

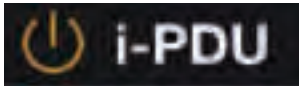

i-BOX Compatible PDU

Integrated Intelligent Power Distribution.

i-PDU has been developed to seamlessly integrate with Cooper B-Line's i-BOX and i-PAL systems (access control and environmental monitoring system) providing the ability to set-up, manage and control an intelligent power distribution solution using standard IP network addressable technology.

Once an i-BOX has been configured on the network and the i-PDU has been connected the system offers the benefit of real time, bi-directional communications with each i-PDU connected. Importantly this provides not only the ability to accurately monitor and record the power consumption values of each i-PDU but allows the system administrator to control the operation of each and everyone of the individual i-PDU sockets.

The i-PDU can be configured to perform users configurable outlet start up sequences. This soft start functionality also includes the provision to allow optimised start up using pre set time delays or current draw thresholds.

The i-PDU contains a precise measuring device that samples for KWH readings 4,000 times per second, readings are reported at scheduled intervals to the centralised database.



Features of i-PDU

- Seamless integration to i-BOX using the same central management software platform (free of charge updates may need to be installed).
- 12 x Individually fused outlets.
 - 10 x IEC-60320 C13 +
 - 2 x IEC-60320 C19.
- Maximum current draw rating of 20 Amps.
- Up to 4 i-PDU's connected to one i-BOX.
- Various power lead termination options including 13 Amp, 16 Amp & 32 Amp plugs.
- Plug and Play connection.
- Fully configurable sequential start-up.
- Mains filtered.
- Protected and monitored on/off switch.
- 2 x 20 Character display.
 - Individual Socket status: on / off / fuse failure and fault.
 - KWH display / Voltage / Current / Firmware and software version.
- Standalone configuration function buttons.

Technical Specifications & Part Codes

Material	Mild Steel Housing
Finish	Painted Black RAL9005
Unit O/A Dimensions	1350mm High x 90mm Wide x 60mm Deep
Unit Weight	5.2kg
Packaged Size	1550mm x 150mm x 150mm (Supplied Individually Boxed)
Packaged Weight	6.35kg

Order Code	Description
IBOXPDU1612WC1316U	<ul style="list-style-type: none"> ■ 220 / 230v A/C 50 Hz. ■ Max rating 20Amps. ■ 12 x Individually fused outlets. <ul style="list-style-type: none"> □ 10 x IEC-60320 C13 + 2 x IEC-60320 C19. ■ Individual outlet status LED. ■ On / Off Switch. ■ Fitted with 3m power supply lead terminated with a UK 3-pin BS1363 plug. ■ Integrated i-BOX power supply outlet. ■ Local PDU status screen. ■ Supplied with i-BOX power supply lead and sensor port connection lead.
IBOXPDU1612WC1316C	<ul style="list-style-type: none"> ■ 220 / 230v A/C 50 Hz. ■ Max rating 20Amps. ■ 12 x Individually fused outlets. <ul style="list-style-type: none"> □ 10 x IEC-60320 C13 + 2 x IEC-60320 C19. ■ Individual outlet status LED. ■ On / Off Switch. ■ Fitted with 3m power supply lead terminated with a 16Amp Commando plug. ■ Integrated i-BOX power supply outlet. ■ Local PDU status screen. ■ Supplied with i-BOX power supply lead and sensor port connection lead.

Compliance ■ WEEE Directive. ■ RoHS Compliant ■ CE Approved

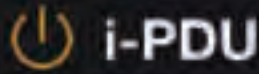

i-BOX Compatible PDU Cont.

Integrated Intelligent Power Distribution.

The new 1U high i-PDU has been developed, like the existing vertical i-PDU to seamlessly integrate with Cooper B-Line's i-BOX and i-PAL systems (access control and environmental monitoring system) providing the ability to set-up, manage and control an intelligent power distribution solution using standard IP network addressable technology.

Once an i-BOX has been configured on the network and the i-PDU has been connected the system provides real time, bi-directional communications with each i-PDU connected. Importantly this not only provides the ability to accurately monitor and record the power consumption values of each i-PDU but also allows the system administrator to control the operation of each and everyone of the individual i-PDU sockets.

The i-PDU can be configured to perform users configurable outlet start up sequences. This soft start functionality also includes the provision to allow optimised start up using pre set time delays or current draw thresholds.

The i-PDU contains a precise measuring device that samples for KWH readings 4,000 times per second, readings are reported at scheduled intervals to the centralised database.



Features of i-PDU

- Compact 1U 19-inch rack mounted unit.
- 12 x IEC-60320 C13 outlets on the rear of the unit.
- Each outlet individually fused.
- Maximum total current draw rating of 20 Amps.
- Up to 4 i-PDU's can be connected to one i-BOX.
- Various power lead termination options including 13 Amp, 16 Amp & 32 Amp plugs.
- Seamless integration to i-BOX using the same central management software platform (free of charge updates may need to be installed).
- Plug and Play connection.
- Fully configurable sequential start-up.
- Mains filtered.
- Protected and monitored on/off switch
- Integrated i-BOX power connection
- LED status lamp.

Technical Specifications & Part Codes

Material	Mild Steel Housing
Finish	Painted Black RAL 9005
Unit O/A Dimensions	43mm H x 483mm W x 250mm D
Unit Weight	4.6kg
Packaged Size	100mm H x 525mm W x 350mm D
Packaged Weight	5.7kg

Order Code	Description		
IBOX1UPDU12WC1316U	<ul style="list-style-type: none"> ■ 220 / 230v A/C 50 Hz. ■ Max rating 20Amps. ■ 12 x Individually fused C13 outlets. ■ Individual outlet status LED. ■ On / Off Switch. 	<ul style="list-style-type: none"> ■ Fitted with 3m power supply lead terminated with a UK 3-pin BS1363 plug. ■ Integrated i-BOX power supply outlet. ■ Supplied with i-BOX power supply lead and sensor port connection lead. 	Details Upon Request
IBOX1UPDU12WC1316C	<ul style="list-style-type: none"> ■ 220 / 230v A/C 50 Hz. ■ Max rating 20Amps. ■ 12 x Individually C13 fused outlets. Individual outlet status LED. ■ On / Off Switch. 	<ul style="list-style-type: none"> ■ Fitted with 3m power supply lead terminated with a 16Amp Commando plug. ■ Integrated i-BOX power supply outlet. ■ Supplied with i-BOX power supply lead and sensor port connection lead. 	Details Upon Request
Compliance	<ul style="list-style-type: none"> ■ WEEE Directive. ■ RoHS Compliant ■ CE Approved 		



i-BOX Shelving

Order Code

Description

IBOXSHELF

i-BOX 19-Inch Front Mounted Sliding Shelf

- 1U high x 315mm deep sliding cantilever shelf finished in Black RAL 9005. Designed to house a single i-BOX the shelf has integrated cable management to ensure connections remain stress free during operation and maintenance.
- The shelf assembly is rated at 15kg load capacity.





i-REM

Intelligent Rack Extinguisher Module

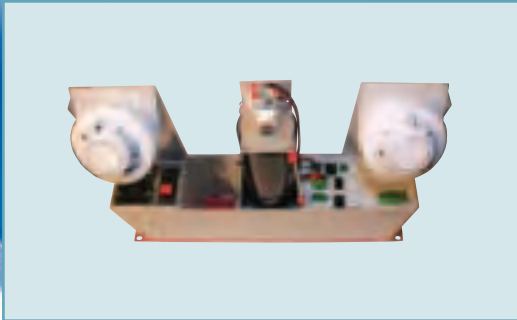

i-REM Data and Fire Protection

Loss of data is perhaps one of the most feared aspects of business. Losing internal records, employee records and sales records alone could cripple even the largest company to the point of collapse. If the company also then relies on these technologies to provide a sales outlet, be it through POS terminals or Internet trading, losing these for any length of time will affect the ability to continue trading in times of crisis.

Enterprises with computer networks, IT communications and those who rely on large banks of data, house their computers, network devices and ancillary equipment in 19-inch floor standing racks/ cabinets, i.e. a "Computer room in a Cabinet". The data is protected against viruses, the computers against power fluctuations with UPS, the excess heat by air conditioning, the security by the latest devices, but the fire protection is often left to the room Fire Protection System. Each individual cabinet is not separately protected.

So why not let your computer room fire system handle the fire? The answer is simply the down time and disruption to business involved in doing so. Your building fire system is perfect for protecting the occupants of the building and the building itself, but generally has little regard for the consequences of dealing with a small fire. Even if you have expensive computer room fire extinguishing capability, this system will still flood the room with agent and close down all the equipment inside the room, requiring your staff to leave the room, until the agent is vented, before returning to deal with the problem.

If you have 20 racks containing data servers, this shuts 95% more of your business than need be affected by a localised fire in one rack. Cooper B-Line can now supply the i-REM, this unit is designed to protect data and equipment sited in closed separate 19-inch racks from the effects of a smoke threat originating within the periphery of the rack. Installed in the top 2U of the cabinet the i-REM's microprocessor will monitor the rack for smoke, using two optical smoke detectors. Power from the rack will be removed at 3% / meter smoke obscuration. The cause of the smoke will be extinguished by filling the rack with FM200 extinguishant with a zero oxygen depletion potential.

Because this affects only the rack with the smoke, the room is safe for your staff to continue working and the rack is immediately available for engineers to repair or replace the faulty equipment, and business is resumed in the shortest possible time.

Features

- Automatic smoke detection, alarm and extinguish with immediate power off to cabinet
- Extendible with additional units up to 8 bayed cabinets
- Supplied fully assembled. 2U 19-inch mounted
- Visual, audible and electronic alarms
- Worldwide universal AC voltage input (96-264VAC)
- Option of gauge or pressure switch monitoring of canister
- Inbuilt microprocessor with battery backup for i-REM

Benefits

Input

- Worldwide operation 90-264Vac (50/60Hz)
- 10 Amp, 16 Amp or 20 Amp IEC inlet

Output

- 10 Amp, 16 Amp or 20 Amp IEC socket outlet corresponding to input
- UPS power shut down contacts
- Remote system alarm contacts
- Remote fire alarm contacts
- Visual and Audible warning indicators

Function

- The on board i-REM unit microprocessor monitors all functions and indicates faults on 4 LED's. Twin smoke detectors continuously monitor the cabinet for smoke at > 3%/m obscuration
- On smoke detection and alarm, i-REM fire extinguisher is operated automatically and cuts power to the outlet socket. UPS-off contact operates, Alarm indicator and remote alarm contacts operate.

Dimensions

- 2U high (87mm) x 345mm deep x 19-inch mounted
- Weight of 6kg or less

Environment

- Ozone Depleting Potential (ODP) is zero
- Minimal atmospheric warming effect
- Extinguishant is non toxic FM200™ or FE36™

Product Details

Order Code	Description	Order Code	Description
IREMX101x800	Master 10amp: 1 x 800grm Extinguishing Canister Fills 1.4M	IREMADPD1	Adapter: Power Off APC-UPS on Smoke alert REPO
IREMX101x1000	Master 10amp: 1 x 1000grm Extinguishing Canister Fills 1.8M	IREMCBLP1	Cable Power 10amp C13F>C14M =3Mtr. UPS to DFP power in.
IREMX102x1000	Master 10amp: 2 x 1000grm Extinguishing Canister Fills 3.6M	IREMCBLP2	Cable Power 16amp C19F>C20M =2.5Mtr. UPS to DFP power in.
IREMX161x1000	Master 16amp: 1 x 1000grm Extinguishing Canister Fills 1.8M	IREMCBLP3	Cable Power 16amp C19F>Free end =2.5Mtr. UPS to DFP power IN.
IREMX162x1000	Master 16amp: 2 x 1000grm Extinguishing Canister Fills 3.6M	IREMCBLP4	Cable Power 16amp C20M>Free end =2.5Mtr. UPS to DFP power OUT.
IREMX201x1000	Master 20amp: 1 x 1000grm Extinguishing Canister Fills 1.8M	IREMCBLP5	Power 16amp Connector C19F Rewireable To DFP power IN.
IREMX202x1000	Master 20amp: 2 x 1000grm Extinguishing Canister Fills 3.6M	IREMCBLP6	Power 16amp Connector C20M Rewireable From DFP power OUT.
IREMXS1x800	Slave 1 X 800grm Extinguishing Can. + connect cables. Fills 1.4M	IREMPDPP1	Power Distribution 16A C20 Input +2m 5 x13amp sockets OUT, Horizontal Mount
IREMXS1x1000	Slave 1 X 1000grm Extinguishing Can. + connect cables. Fills 1.8M	IREMPDPP1	Power Distribution 16A C20 Input +2m 9 x13amp sockets OUT, Vertical Mount
IREMXS2x1000	Slave 2 X 1000grm Extinguishing Can. + connect cables. Fills 3.6M	IREMADPD6	APC UPS Power Off w/- EPO (Emergency Power Off)
IREMXEPS800	Extinguisher canister only 800grms FM200 w/- Pressure-Switch.	IREMX10M	Master Unit 10amp: (drives 1 slave)
IREMXEPS1000	Extinguisher canister only 1000grms FM200 w/- Pressure-Switch.	IREMX16M	Master Unit 16amp: (drives 1 slave)
IREMCBLD3	Multi-Bay connecting cable for 3 / 4 Bayed Racks.	IREMX20M	Master Unit 20amp: (drives 1 slave)
IREMCBLD4	Multi-Bay 5 - 8 Bayed Racks. Connect Box+ Cables. Specify No. of racks	IREMXS	Slave Unit With 3 connecting cables



Intelligent Rack Extinguisher Module Cont.

i-REM Data and Fire Protection

Concentration of Extinguishant - FM200 in Enclosures

50630 Calculations of Volume filled with specified quantity of FM200 (Fire Extinguishant) at various concentrations and temperatures.

The most critical aspect of the specification for protection of your Cabinet from the damage of Smoke & Fire is to determine the "free volume" of your cabinet and its "leakage".

Rack-free volume

This is the reduced cabinet volume after solid metal and airtight enclosures are subtracted.

Leakage is caused by:

- Unnecessary leakage from leaving gaps, e.g. around cable inlets at the base of the rack.
- Necessary ventilation to provide enough air flow to cool the electronic equipment, usually computers.

FM200 is heavier than air and drops down the cabinet and will leak out of any unsealed gaps around the lower cable entries.

Specify the weight of Extinguishant to achieve concentration of 7% minimum in the protected enclosure.

FM200 Base Data^{*A} NFPA2001

Temp °C	S.V.V.*1 m ³ /kg	Kgs per m ³ at % concentrations of HFC-227ea				
		6%	7%	8%	9%	10%
-5	0.1241	0.5142	0.6064	0.7005	0.7987	0.8951
0	0.1268	0.5034	0.5936	0.6858	0.78	0.8763
+5	0.1294	0.4932	0.5816	0.6719	0.7642	0.8586
+10	0.1321	0.4834	0.57	0.6585	0.749	0.8414
+15	0.1347	0.474	0.5589	0.6457	0.7344	0.8251
+20	0.1373	0.465	0.5483	0.6335	0.7205	0.8094
+25	0.1399	0.4564	0.5382	0.6217	0.7071	0.7944

*1 Specific Vapor Volume

Cabinet Volumes^{*B}

Cabinet Concentration^{*C}

with 800grms @ 20°C

with 1000grms @ 20°C

Height U	39U 42U 47U			39U 42U 47U			39U 42U 47U		
	1.9	2.0	2.2	1.9	2.0	2.2	1.9	2.0	2.2
Height Mtr.	Volume m3 of Cabinets			% Concentration @ 20°C			% Concentration @ 20°C		
6x6 Rack	0.68	0.72	0.79	16.01%	15.21%	13.83%	20.06%	19.06%	17.32%
6x8 Rack	0.91	0.96	1.06	12.01%	11.41%	10.37%	15.04%	14.29%	12.99%
6x10 Rack	1.14	1.20	1.32	9.61%	9.13%	8.30%	12.04%	11.43%	10.39%
8x6 Rack	0.91	0.96	1.06	12.01%	11.41%	10.37%	15.04%	14.29%	12.99%
8x8 Rack	1.22	1.28	1.41	9.00%	8.55%	7.78%	11.28%	10.72%	9.74%
8x10 Rack	1.52	1.60	1.76	7.20%	6.84%	6.22%	9.03%	8.58%	7.80%
8x12 Rack	1.82	1.92	2.11	6.00%	5.70%	5.18%	7.52%	7.15%	6.50%

Canister

with 800grms of FM200

with 1000grms of FM200

Temp °C	M ³ filled at % concentration				M ³ filled at % concentration			
	7%	8%	9%	10%	7%	8%	9%	10%
-5	1.32	1.14	1.00	0.89	1.65	1.43	1.25	1.12
0	1.35	1.17	1.03	0.91	1.68	1.48	1.28	1.14
+5	1.38	1.19	1.05	0.93	1.72	1.49	1.31	1.16
+10	1.40	1.21	1.07	0.95	1.75	1.52	1.34	1.19
+15	1.43	1.24	1.09	0.97	1.79	1.55	1.36	1.21
+20	1.46	1.26	1.11	0.99	1.82	1.58	1.39	1.24
+25	1.49	1.29	1.13	1.01	1.86	1.61	1.41	1.26

FM200 Base Data^{*A} NFPA2001

FM200, FE227, (HFC-227ea). Worlds most widely used safe-in-kind replacement for Halon 1301. Boils at -16°C. Has zero ozone depleting potential. It is safe clean and electrically non-conducting so virtually eliminating collateral damage to computing and other delicate electronic equipment.

*A Data from NFPA 2001 Standard on Clean Agent Fire Extinguishing Systems

*B No consideration for installed Equipment

*C Concentration of Extinguishment in enclosure will increase with rise in temperature

Cabinet Lighting

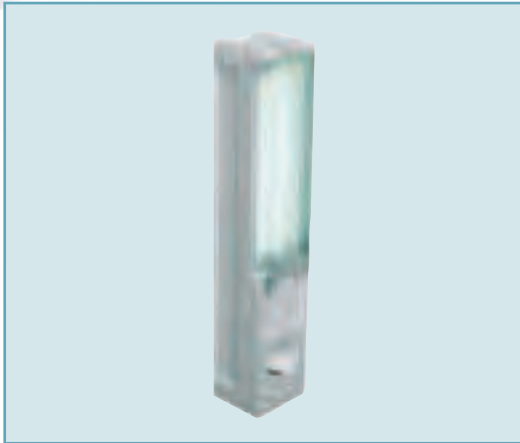

Compact Lamp KL 025 Series

- Magnetic or optional DIN rail mounting
- Energy-saving lamp
- Lamp without/with electrical socket (choice of sockets)
- On/Off switch

The compact lamp KL 025 was especially designed for use in enclosures. A powerful magnet enables the lamp to be mounted freely in any desired position in metal enclosures saving time and installation problems. The integrated electrical socket allows the use of additional appliances.

Product Information

Order Code	Operating Voltage	Socket	Power consumption	Nominal Current	Protection class	Approvals
KL02500	230VAC, 50Hz	Germany (1)	11W (equals 75W light bulb)	16.0A	I (earthed)	VDE
KL02507	230VAC, 50Hz	none	11W (equals 75W light bulb)	-	II (double insulated)	-
KL02501	230VAC, 50Hz	France/Poland (2)	11W (equals 75W light bulb)	16.0A	I (earthed)	-
KL02502	230VAC, 50Hz	Switzerland (3)	11W (equals 75W light bulb)	10.0A	I (earthed)	-
KL02510	230VAC, 50Hz	UK/Ireland (4)	11W (equals 75W light bulb)	13.0A	I (earthed)	-
KL02512	230VAC, 50Hz	Italy (6)	11W (equals 75W light bulb)	16.0A	I (earthed)	-
KL02505	120VAC, 60Hz	USA/Canada (5)	9W (equals 60W light bulb)	15.0A	I (earthed)	-
KL02506	120VAC, 60Hz	none	9W (equals 60W light bulb)	-	II (double insulated)	-



Magnetic Internal Lighting Unit

See the Cooper B-Line Accessories Catalogue for our full range of cabinet lighting systems

Ancillary Accessories

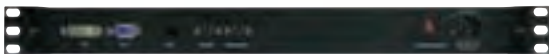

Rack Director

The Rack Director is a true 1U display console that allows you to control any number of servers from one location. The space requirement is dramatically reduced as there's no need to house separate monitors and keyboards. With a number of features listed below the Rack Director is the perfect complement to any comms room.

- Unique Dual slides for flatpanel & for keyboard
- On Screen Display (OSD) on LCD Display
- 105 keys ps/2 keyboard with easy glide touchpad
- Power LED indicator
- Keylock mechanism
- 3 power on/off feature
- 3 in 1 flex cable-- Bright Active Matrix TFT Display
- Compact, Low Profile
- DB-25 Keyboard/Mouse/Video input
- Hidden Handle for keyboard tray
- Subject to lead time and minimum order quantity. Can be supplied with 8 port and 16 port KVM switch

Description	Order Code
1U 19-inch Rack Director display console with 17-inch viewing area - no KVM Switch	1U17TFT0KVM
1U 19-inch Rack Director display console with 15-inch viewing area - no KVM Switch	1U15TFT0KVM

Document Wallets Technical Data

Order Code	Description
DW	Self Adhesive Document Wallet 250mm Wide x 236mm High x 32.5mm Deep Finished Grey
DWO	Self Adhesive Document Wallet 250mm Wide x 236mm High x 32.5mm Deep Finished Orange
DWA	Self Adhesive Document Wallet 180mm Wide x 220mm High x 20mm Deep Finished Transparent
DWB	Self Adhesive Document Wallet 140mm Wide x 170mm High x 10mm Deep Finished Transparent
DWC	Self Adhesive Document Wallet 110mm Wide x 130mm High x 7mm Deep Finished Transparent



Access Cabinet Technical Specification

Designed for loads up to 1000kg when supported equally on the vertical panel mounts and using either the skid, castor or jacking foot options.

Technical Specification

Framework

The Access range has a top and bottom tubular frame, which is clad with sheet steel fascias and connected by two vertical aluminium extrusions. (UK and World - wide Patents Pending)

	Material
■ Tube Frames	25mm x 25mm x 2.5mm wall thickness corner welded steel tube.
■ Fascias	1.2mm Steel CR4 Zinc Coated
■ Centre Vertical Uprights	Aluminium extrusion. (Density 2.97 Kg per Metre)
■ Corner Trims	Nylon 66
■ Glass	4mm Toughened BS6206 1981- grey tint - exposed edges polished, bonded edges.

Cladding Panels

	Material
■ Side Panels	1.2mm Steel CR4
■ Rear Door	1.5mm Steel CR4
■ Front Door Styles	1.5mm Steel CR4
■ Top Panels	1.2mm Steel CR4
■ Hinge Mouldings	Nylon 66

19-inch/ETSI Panel Mounts and 800/600 reducers.

Conforming to IEC 297 or ETSI 300-119 Part 3 standards with mounting facilities for universal front fixing and Cooper B-Line side mounting accessories.

	Material
■ Cross 800/600 reduction rails	2.0mm Steel CR4
■ Vertical panel mounts 19-inch	2.0mm Steel CR4
■ Vertical panel mounts ETSI	2.0mm Steel CR4
Castor Plate/Plinth Plate	
■ Corner Plates	3.0mm Steel CR4
■ Kick Plate Trim	1.2mm Steel CR4
■ Castor	250 Kg per castor rated loading
■ Jacking Foot	2,000 Kg static load
■ Skid	Nylon 6

Fixing Screws

- Main fixings M6 Socket set screws - Tensile Strength 10.9
- All other fixings M6 screws - Tensile Strength 8.8

Access Cabinet Technical Specification Cont.

Technical Specification Cont.

IP Rating IEC529

- IP20

Earthing / Earthing Kit

- Compliant to EN60950 Clause 2.5.11

Earthing Specification

The resistance of the connection between earthing terminal or earthing contact and parts required to be earthed shall not exceed 0.1 ohms. The test current shall be 1.5 times the current capacity of any hazardous voltage circuit at the point where failure of basic insulation would make the earth point live. The test voltage shall not exceed 12V and the test current may not be more than 25 A.

Locking System

- Each door has a central, pull out and 90 ° turn locking handle with two point espan locking.
- Doors are hinged LH as standard but can be supplied or converted to RH hinged
- Handle and espan guides - Nylon 66, Locking rods 8mm MS Bar

Accessories

- Specific to Access – Top fan trays, Plinth/Castor/Jacking foot kits, Cable mounting accessories.
- Universal - All depth fitting accessories using the Cooper B-Line panel mount side fixings are compatible with the Access rack. All front mounting accessories using the front 19-inch mountings are compatible.

Components

Std. Colour Finish

- | | |
|---|--|
| ■ Corner Mouldings, Door Hinge Mouldings
Door Lock assembly. | NCS 4550 -R90B Blue (VDI 22 texture) |
| ■ Vertical Extrusions. | NCS 4550 -R90B Blue
Structured Epoxy Polyester Powder DFT 50 Microns |
| ■ Top Frames, Top Panels, Side Panels
and Doors. | NCS 1502Y Light Grey
Structured Epoxy Polyester Powder DFT 50 Microns |
| ■ Panel Mounts,800/600 reducers/Top Panel fixing
channels/lock rods and fixings. | Zinc and Tivalent Passivate BS EN 12329:2000 |

UL Listing

NWIN.E235184 - Information Technology and Communications Equipment Cabinet, Enclosure and Rack Systems

Information Technology and Communications Equipment Cabinet, Enclosure and Rack Systems

See General Information for Information Technology and Communications Equipment Cabinet, Enclosure and Rack Systems

COOPER B-LINE INC

E235184

509 W MONROE ST

HIGHLAND, IL 62249 USA

Safety of Information Technology Equipment - UL 60950

1.1 Scope

1.1.1 Equipment covered by this standard

This standard is applicable to mains-powered or battery-powered information technology equipment, including electrical business equipment and associated equipment, with a RATED VOLTAGE not exceeding 600 V and designed to be installed in accordance with the Canadian Electrical Code, Part I, CSA C22.1; CSA C22.2 No. 0; and the National Electrical Code, NFPA 70 .

The standard is also applicable to equipment, unless otherwise identified by a marking or instructions, designed to be installed in accordance with Article 645 of the National Electrical Code, NFPA 70, and the Standard for the Protection of Electronic Computer Data-Processing Equipment, NFPA 75.

See annex nae for examples of and references to regulatory requirements that may apply to this equipment.

This standard is also applicable to such information technology equipment designed and intended to be connected directly to a TELECOMMUNICATION NETWORK, regardless of the source of power.

It is also applicable to such information technology equipment designed to use the AC MAINS SUPPLY as a telecommunication transmission medium (see note 4 of clause 6).

This standard specifies requirements intended to reduce risks of fire, electric shock or injury for the OPERATOR and layman who may come into contact with the equipment and, where specifically stated, for SERVICE PERSONNEL.

This standard is intended to reduce such risks with respect to installed equipment, whether it consists of a system of interconnected units or independent units, subject to installing, operating and maintaining the equipment in the manner prescribed by the manufacturer.

Safety of Information Technology Equipment - UL 60950 Cont.

This list is not intended to be comprehensive, and equipment that is not listed is not necessarily excluded from the scope.

Equipment complying with the relevant requirements in this standard is considered suitable for use with process control equipment, automatic test equipment and similar systems requiring information processing facilities. However, this standard does not include requirements for performance or functional characteristics of equipment.

1.1.2 Additional requirements

Requirements additional to those specified in this standard may be necessary for:

- equipment intended for operation in special environments, for example, extremes of temperature; excessive dust, moisture or vibration; flammable gases; and corrosive or explosive atmospheres;
- electromedical applications with physical connections to the patient;
- equipment intended to be used in vehicles, on board ships or aircraft, in tropical countries, or at altitudes greater than 2 000 m;
- equipment intended for use where ingress of water is possible; for guidance on such requirements and on relevant testing, see annex t.

NOTE - Attention is drawn to the fact that authorities of some countries impose additional requirements.

1.1.3 Exclusions

This standard does not apply to:

- support equipment, such as air conditioning, fire detection or fire extinguishing systems;
- power supply systems, such as motor-generator sets, battery backup systems and transformers, which are not an integral part of the equipment;
- building installation wiring;
- devices requiring no electrical power.

Access Cabinet Technical Specification Cont.

Access Cabinet System. Load Test Reference – 08022008_A4788

Product Part Number:	A4288C
Product Description:	Access Cabinet - 42U x 800mm wide x 875mm deep
Test Date:	8th February 2008
Test Agency:	Speedy Lifting Gear Hire Avon Trading Estate St Philips Bristol BS2 0XA
Supervised By:	Mr C M Wright Engineering Manager Cooper B-Line Ltd
Test Procedure	The 42U Access rack was fitted with 12 full depth shelves; each shelf was loaded with 5 x 20Kg test weights. Total weight 1100Kg.
Acceptance	The enclosure is to be loaded evenly with a weight to simulate a fully loaded enclosure. The unit must support 1000Kg static load.
Results	The Access cabinet was loaded with the full range of test weights available providing a static load of 1100Kg. <ul style="list-style-type: none"> ■ 750Kg No deformation. ■ 1000Kg Slight deformation (2mm) to the ends of the (AA8) cross rail. ■ 1100Kg No further deformation.x



Approved For Release	Name	Date	Signature
Engineering / Design:	Colin Wright	11 / 02 / 2008	
Product Manager:	Gery Bowler	11 / 02 / 2008	

CFD Analysis

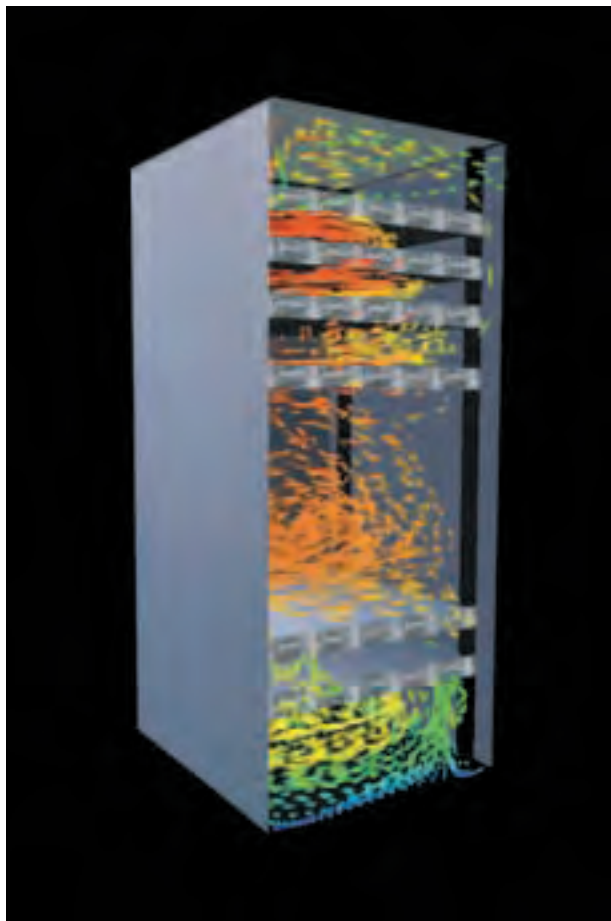

Overview

With rack space becoming a crucial element within the planning of IT infrastructure, the ability to maximise the amount of equipment into the rack increases.

Servers get thinner and deeper, IT compaction and cable management becomes critical leading to rising heat densities causing equipment failure and costly system downtime.

As part of Cooper B-Line's Critical Asset Protection Solution, the rack system supplied can now be validated using computational fluid dynamics (CFD). Flotherm has become the standard for many electronics companies worldwide. This evolution of thermal analysis allows B-Line to ascend to the next level of productivity, by greatly enhancing its integration into the rack design process, the most challenging thermal problems can be solved.

Cooper B-Line has recognised that the challenge of solving rising heat densities within the rack environment is a crucial part of critical asset protection. By adopting Flotherm and its new approach to analysis software called "Design Class Analysis" rack solutions which cater for the direct needs of design engineers are now available.

- CFD Validation
- High Density Cooling System
- Efficient Cooling Where Required
- Flexible Solution Up To 20KW per Rack

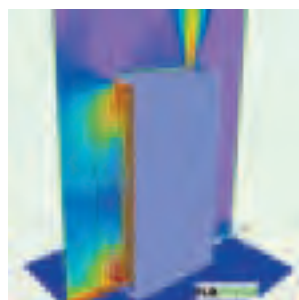
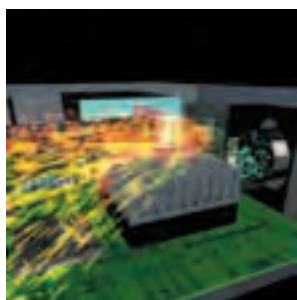

Access Configurator



“Probably the best **FREE** tool you will ever use”

The Access Configurator software has been developed to provide a unique method of assisting with the design, configuration and layout of the Access Cabinet Range.

It allows the user to construct a cabinet to their own specification by using a building block approach to select cabinet components from the many options available.

Once the user has built their 'virtual rack', they are able to visualise the design by using a fully interactive 3D model. A snapshot of the model can then be saved as an image file for use with reports or for later reference.

- **Cabinet configuration**
- **Cabinet layout**
- **Visualisation of final cabinet build**
- **Quotations**
- **Allows for tailored cabinet build to specification**
- **Equipment and accessories can be shown in position**
- **Final Cabinet image can be viewed on screen**
- **Image can be saved to file**
- **View orientation can be modified**

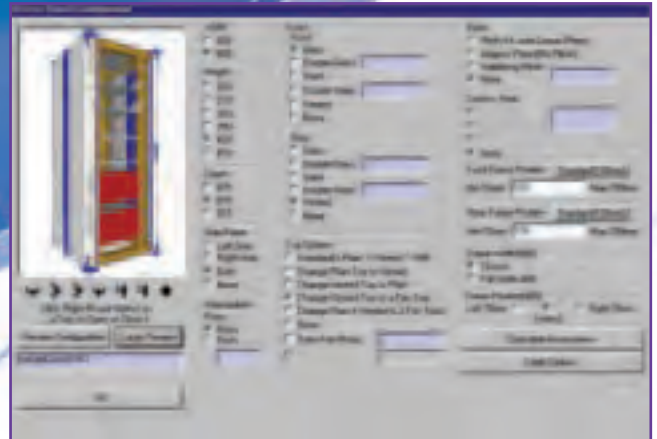

Main configuration screen showing cabinet options.

The software includes a library of standard accessories that can be placed into a rack layout screen, which provides a useful equipment 'U position' layout guide. This layout can then be displayed in the 3D model giving an excellent visualisation of a populated rack.

As well as providing a detailed breakdown of each component used, the software also builds up a convenient master part number with a full description of all items used. This information can then be read by the report generator to provide a detailed quote or customer enquiry complete with images previously generated in the configuration screen.

Once a configuration is finished it can be easily stored and retrieved as a project file. There is also a useful contact database for storing client information.

Once the selection is made, the final results are displayed in the interactive 3D model shown opposite.

A preferred 'snapshot' of the resulting picture can then be saved as an image file.



Order Ref: CBLC

How To Software

'How To' Interactive Software

Want to know 'How To'?

Additional support software is also available either on disc or from our web site. www.cooperline.co.uk

These include the Access 'How to' software, designed to give an interactive presentation of the features and benefits of the Access range. It also gives installation assistance by showing 'how to' assemble certain components within the cabinet.

Other presentations providing additional information are also available.

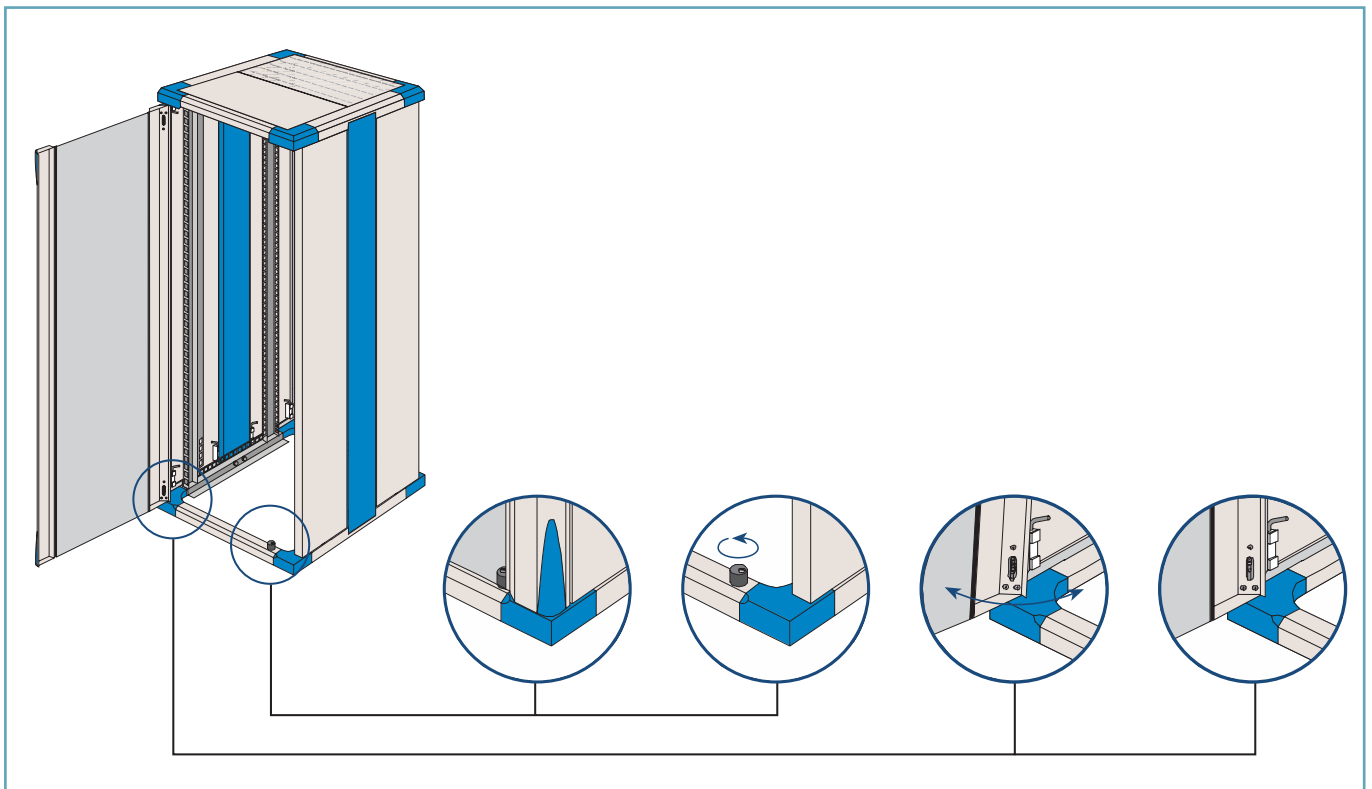

Technical Capabilities



Overview

Realising a new product or solution to the correct specification and at the right time does not happen by accident. We rely upon using the latest in manufacturing techniques. On-going improvement is crucial to ensuring that the company has the most cost effective manufacturing processes that offer timely introduction of new products to the right specification.

The most important element of product realisation is the Cooper B-Line manufacturing facility. The company has the latest in turret punching capability, which is also supplemented by a laser. The laser offers a very high level of flexibility and allows fast, complex production without the need for special tooling.

Following the turret punching process sheet metal products have to be formed and this is completed using a variety of CNC Press Brakes.

Again these machines offer "high speed" production with a high degree of flexibility.

Automated Punching & Profiling

Computer Aided Manufacture 'CAM' Systems - Auto Machining & Nesting for automated component tool path and machining strategies, plus automated nesting & optimisation with full DNC links to CNC presses.

- 3 Amada CNC Turret Punches
- 1 Flying Head Laser Press
- Capability to punch 4m x 1.5m Sheets
- "Off Line" Programming facility
- Brush beds for high quality finishes

Forming & Press Braking

The site currently has 9 Press Brakes, 6 of which are linked directly for numerical control 'NC' programming. Up to 160 ton capacity and up to 3m beds.



Welding

Our coded welders conform to BSEN 287/8 and weld all types of materials; Mild Steel, Stainless Steels, Pre Galvanised Steels, Aluminium, and Zintec, using the processes of MIG, TIG, Arc and Gas. Other aspects include Spot Welding to 150 kvA and Stud Welding up to M8.

After welding there is the process for finishing. This can take the form of de-burring, grinding, finishing and cleaning in preparation for the product to be painted or other desired finish.



Paint Finishing

Our in-house paint facility is an Automatic Iron Phosphate pre-treatment and powder paint facility, spraying epoxy polyester and polyester powders.

It features 'roll on roll off' booths providing fast colour changes, combined with environmentally friendly powder recovery systems.

Wet Paint

There are 4 waterwash booths, an overhead and trolley conveyor, stoving oven and a material size capacity of 1.5m x 2m x 3m.



Assembly & Integration

The site has two main assembly areas, which gives flexibility for standard products and custom solutions with dedicated assembly lines for specific product ranges.

Cooper B-Line know that simply offering sheet metal components and enclosures is no longer "enough" in today's market. As part of the product offering Cooper B-Line can supply solutions complete with:-

- Thermal management systems such as fan units, heat exchangers, air-conditioners and water-cooled heat exchangers
- Environmental sealing, humidity control and heaters
- Integration of cable management and active components from security and system monitoring to PDU's and PSU's
- Third party equipment installation
- Functionality testing
- Deployment to site

Access Custom Capabilities

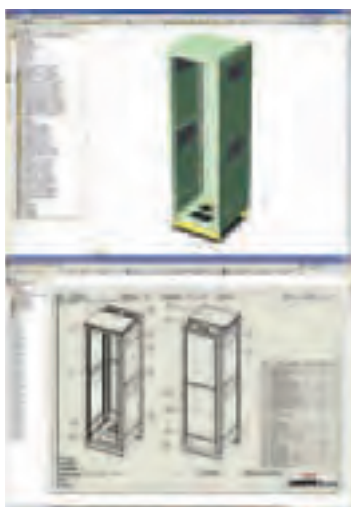

Overview

With short life cycles and the requirement to differentiate a product from the competition, the design of an enclosure can be crucial to its success. Cooper B-Line can offer a full product development service.

The first part of this process is to create an image for the product. Using the company's latest CAD technology, it is possible to create a number of "concept" models to allow customers to visualise how their product will look.

The concept models can also be rendered in corporate or the intended colour scheme to show the potential of each design. This can then be used to examine cable routings and the layout of equipment mounted in the enclosure.

Cooper B-Line offer a design service, turning your concepts and specifications into reality. It is also possible for Cooper B-Line to provide software to view the various concept designs to enable the customer to make internal presentations.

Product Development

Having designed a product to a customer specification or adopted an existing design, Cooper B-Line will then begin the development process.

This will consist of a number of key activities to ensure that the correct bills of materials are available, special tooling is developed and if required, prototypes can be produced for evaluation.

Design & Engineering

Our team of Engineers utilise the latest CAD/CAM systems, which means we can provide innovative design solutions to meet customers needs. This includes providing links to customers CAD systems, using native CAD and all other major interchange systems.

The benefits of using the Latest CAD Technology allows:-

- Electronic links via most standards, including IGES, STEP and DXF
- Widest used CAD systems
- Fully Parametric
- Best in class sheet metal packages
- Thermal Dynamic / Fluid Dynamics capability

Thus giving the customer excellent product design & development solutions with pre & post sales technical support.



the 19" company